

# Conservation compatible energy retrofit technologies

**Part II:** Documentation and assessment of conventional and innovative solutions for **conservation and thermal enhancement of window systems** in historic buildings

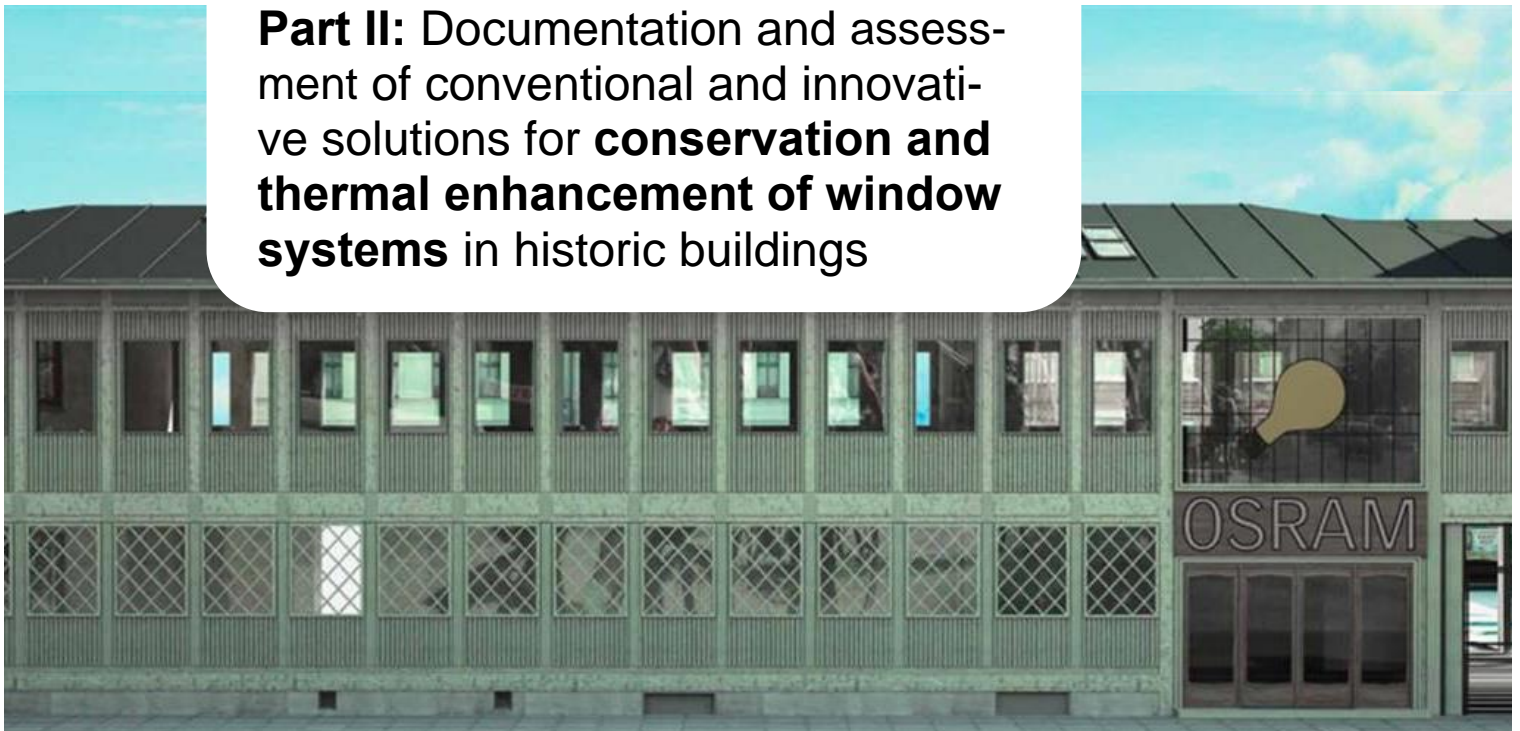

# Conservation compatible energy retrofit technologies

## **Part II: Documentation and assessment of conventional and innovative solutions for conservation and thermal enhancement of window systems in historic buildings**

**Editor: Alexander Rieser (UIBK)**

Contributing authors: Dagmar Exner (Eurac), Jørgen Rose (SBI), Élodie Héberlé (Cerema), Sara Mauri (Polimi)

**October 2021**

**SHC Task 59 | EBC Annex 76 | Report D.C1-II,**

**DOI: [10.18777/ieashc-task59-2021-0005](https://doi.org/10.18777/ieashc-task59-2021-0005)**

*The contents of this report do not necessarily reflect the viewpoints or policies of the International Energy Agency (IEA) or its member countries, the IEA Solar Heating and Cooling Technology Collaboration Programme (SHC TCP) members or the participating researchers.*

## IEA SHC Task 59 | EBC Annex 76: Deep renovation of historic buildings towards lowest possible energy demand and CO<sub>2</sub> emission (NZEB)

### Solar Heating and Cooling Technology Collaboration Programme (IEA SHC)

The Solar Heating and Cooling Technology Collaboration Programme was founded in 1977 as one of the first multilateral technology initiatives (“Implementing Agreements”) of the International Energy Agency.

**Our mission** is “Through multi-disciplinary international collaborative research and knowledge exchange, as well as market and policy recommendations, the IEA SHC will work to increase the deployment rate of solar heating and cooling systems by breaking down the technical and non-technical barriers.”

**IEA SHC** members carry out cooperative research, development, demonstrations, and exchanges of information through Tasks (projects) on solar heating and cooling components and systems and their application to advance the deployment and research and development activities in the field of solar heating and cooling.

**Our focus areas**, with the associated Tasks in parenthesis, include:

- Solar Space Heating and Water Heating (Tasks 14, 19, 26, 44, 54)
- Solar Cooling (Tasks 25, 38, 48, 53, 65)
- Solar Heat for Industrial and Agricultural Processes (Tasks 29, 33, 49, 62, 64)
- Solar District Heating (Tasks 7, 45, 55)
- Solar Buildings/Architecture/Urban Planning (Tasks 8, 11, 12, 13, 20, 22, 23, 28, 37, 40, 41, 47, 51, 52, 56, 59, 63, 66)
- Solar Thermal & PV (Tasks 16, 35, 60)
- Daylighting/Lighting (Tasks 21, 31, 50, 61)
- Materials/Components for Solar Heating and Cooling (Tasks 2, 3, 6, 10, 18, 27, 39)
- Standards, Certification, and Test Methods (Tasks 14, 24, 34, 43, 57)
- Resource Assessment (Tasks 1, 4, 5, 9, 17, 36, 46)
- Storage of Solar Heat (Tasks 7, 32, 42, 58, 67)

In addition to our Task work, other activities of the IEA SHC include our:

- SHC Solar Academy
- *Solar Heat Worldwide*, annual statistics report
- SHC International Conference

#### Our members

Australia	European Copper Institute	SICREEE
Austria	France	Slovakia
Belgium	Germany	South Africa
Canada	International Solar Energy Society	Spain
CCREEE	Italy	Sweden
China	Netherlands	Switzerland
Denmark	Norway	Turkey
EACREEE	Portugal	United Kingdom
ECREEE	RCREEE	
European Commission	SACREEE	

For more information on the IEA SHC work, including many free publications, please visit [www.IEA.SHC.org](http://www.IEA.SHC.org).

### Energy in Buildings and Communities Technology Collaboration Programme (IEA EBC)

To reach the objectives of SHC Task 59 the IEA SHC implementing Agreement has collaborated with the IEA EBC Implementing Agreement at a “Medium Level Collaboration”, and with the IEA PVPS Implementing Agreement at a “Minimum Level Collaboration” as outlined in the SHC Implementing Agreement’s Policy on Collaboration.

---

# Contents

---

- Contents** ..... **4**
- 1 Introduction** ..... **5**
  - 1.1.1 Subtask C: Conservation compatible retrofit solutions..... 5
  - 1.1.2 Contents of the report..... 5
- 2 Window solutions: Conservation and restauration of historic windows with likewise enhancement on energy efficiency and user comfort** ..... **6**
  - 2.1 Basic energy properties of windows ..... 6
  - 2.2 Introduction..... 10
  - 2.3 Solutions with low impact ..... 12
  - 2.4 Solutions with impact on the appearance from inside ..... 19
  - 2.5 Solutions with impact on the appearance from outside (and inside)..... 32
  - 2.6 Solutions with impact on the whole window..... 38
  - 2.7 Assessment of solutions according EN 16883:2017 ..... 44
    - 2.7.1 Methodology of Assessment..... 44
    - 2.7.2 Detailed Assessment of Windows..... 44
    - 2.7.3 Detailed assessment examples of window solutions ..... 48
    - 2.7.4 References ..... 56

---

# 1 Introduction

---

## 1.1.1 Subtask C: Conservation compatible retrofit solutions

The main objective of Subtask C is to identify, assess and in some cases further develop retrofit solutions and strategies for historic buildings. The solutions should fulfil the conservation compatibility of historic buildings as well as energy efficiency goals towards lowest possible energy demand and CO<sub>2</sub> emissions (NZEB). Further, the objective is to make the solutions available for comprehensive integrated refurbishing concepts and strategies.

Subtask C aimed at identifying replicable solutions from case studies documented in Subtask A and ongoing R&D-projects on conservation compatible retrofit solutions and strategies. Specific focus was given to the following thematic areas: (i) windows, (ii) insulation of external walls, (iii) Heating (production, distribution) and ventilation systems, (iv) solar thermal and photovoltaic systems. The following report presents the results for the thematic area "windows".

## 1.1.2 Contents of the report

This report is basically divided into three chapters. The first chapter (chapter 2.1) describes basic window properties to give an overview of the energy efficiency-related aspects of window solutions. The second part forms the core of this report and contains the documentation of 15 different window solutions categorized based on the impact of the interventions. For the documentation of the solutions, simple open questions were answered by the partners of SHC Task 59 and the ATLAS Interreg Project in order to enable a continuous structure of the solutions. The solutions are basically divided into four groups: Chapter 2.2 Solutions with low impact, Chapter 2.3 Solutions with impact on the appearance from inside, Chapter 2.4 Solutions with impact on the appearance from outside (and inside) and Chapter 2.5 Solutions with impact on the whole window.

The third part of this report contains an evaluation method for the renovation solutions for windows. For this purpose, the assessment categories according to EN 16883 were taken as a basis and adapted in detail for windows. In order to illustrate the detailed assessment, two different solutions were tested using the adapted assessment criteria and are included in the last chapter of this report.

## 2 Window solutions: Conservation and restoration of historic windows with likewise enhancement on energy efficiency and user comfort

### 2.1 Basic energy properties of windows

This very brief introduction of the basic energy properties of windows was taken from [1].

The energy properties of a window can be split into three parts: the U-value of the frame, the U-value of the glass and the solar energy transmittance of the glass. The U-value of the glass and frame can be combined to find the total U-value of the window, i.e., the transmission heat loss coefficient. The solar energy transmittance (g-value) expresses how much of the incident solar radiation that the glass allows to pass to the building.

The total U-value of a window can be determined using formula (1).

$$U = \frac{A_g \cdot U_g + l_g \cdot \psi_g + A_f \cdot U_f}{A_{tot}} \quad (1)$$

Where

$A_g$  is the area of the glazing [m<sup>2</sup>]

$U_g$  is the thermal transmittance of the glazing [W/m<sup>2</sup>K]

$l_g$  is the length of the spacer profile [m]

$\Psi_g$  is the linear thermal transmittance of the spacer profile [W/mK]

$A_f$  is the area of the frame [m<sup>2</sup>]

$U_f$  is the thermal transmittance of the frame [W/m<sup>2</sup>K]

$A_{tot}$  is the total window area [m<sup>2</sup>]

The layers of glass and coating positions are shown in figure 1.



Figure 1. Two layers of glass (1 and 2) and four possible coating positions (1, 2, 3 and 4).

In the following, typical values for different glazing and frames can be found for reference.

Table 1. The most common glazing systems (not including variants with inherent solar shading). The heat loss coefficient is given for three different types of gases 100% air, 90% argon and 90% krypton. The glazing systems are described as e.g., 4-12-4 meaning 4 mm glass, 12 mm air/gas and 4 mm glass. Coating refers to low- $\epsilon$  coating and the table provides the position of the coating from the outside, e.g., "3" would be on the second layer of glass facing the air cavity.

Glazing type	Coating	Heat loss coefficient	Light transmittance	Total solar transmittance
		$U_g$ [W/m <sup>2</sup> K]	$\tau_t$ [-]	$g$ [-]
Mm	Position			

		Air – Argon – Krypton		
Regular floatglass				
4		5.8	0.90	0.86
4-12-4		2.9 – 2.7 –	0.82	0.76
4-12-4-12-4		1.9 – 1.8 –	0.74	0.68
Regular floatglass + energy glazing (type 1, 2 or 3)				
4-coupled-4 (1)	3	1.8 –	0.75	0.71
4-12-4-coupled-4 (1)	5	1.3 –	0.69	0.63
4-12-4 (1)	3	1.9 – 1.6 – 1.5	0.75	0.71
4-15-4 (1)	3	1.7 – 1.5 – 1.5	0.75	0.71
4-24-4 (1)	3	1.7 – 1.5 – 1.5	0.75	0.71
4-12-4 (2)	3	1.8 – 1.5 – 1.3	0.77	0.66
4-15-4 (2)	3	1.6 – 1.3 – 1.3	0.77	0.66
4-24-4 (2)	3	1.6 – 1.4 – 1.4	0.77	0.66
4-15-4 (3)	3	1.4 – 1.1 – 1.1	0.75	0.63
6-15-6 (2)	3	1.6 – 1.3 –	0.75	0.63
4-15-4 (2)	2	1.6 – 1.3 –	0.77	0.61
4-12-4-12-4 (2)	5	1.4 – 1.1 –	0.70	0.59
4-15-4-15-4 (3)	5	1.1 – 0.9 – 0.8	0.68	0.53
4-12-4-12-4 (3)	2 + 5	0.8 – 0.6 – 0.5	0.62	0.40

Energy glazing is a designation for glass with an emissivity  $\varepsilon < 0.2$

Energy glazing type 1: Hard low-emission coating

Energy glazing type 2: Hard low-emission coating  $\varepsilon = 0.1$

Energy glazing type 3: Hard low-emission coating  $\varepsilon = 0.04$

For glazing including solar shading table 2 provides an overview of the possibilities.

Table 2. The most common glazing systems for solar shading. The heat loss coefficient is given for three different types of gases 100% air, 90% argon and 90% krypton. The glazing systems are described as e.g., 4-12-4 meaning 4 mm glass, 12 mm air or gas and 4 mm glass.

Glazing type	Coating	Heat loss coefficient	Light transmittance	Total solar transmittance
		$U_g$ [W/m <sup>2</sup> K]	$\tau$ [-]	$g$ [-]
Mm	Position			
Air – Argon – Krypton				
Solar shading glass (dyed through) + energy glazing (2)				
6 grey-15-6 (2)	3	1.6 – 1.3 –	0.36	0.37
6 green-15-6 (2)	3	1.6 – 1.3 –	0.63	0.39
Solar shading glass (coated) + energy glazing (2)				
6 silver-15-6 (2)	3	1.5 – 1.3 –	0.17	0.17
6 blue-15-6 (2)	3	1.5 – 1.3 –	0.26	0.22
6 grey-15-6 (2)	3	1.5 – 1.3 –	0.27	0.27
Solar shading glass (coated incl. low- $\varepsilon$ coating) + regular float glass (or energy glazing (2))				
4 clear-15-4	2	1.4 – 1.1 –	0.65	0.44
6 clear-15-6	2	1.4 – 1.1 –	0.65	0.44
6 neutral-15-6	2	1.6 – 1.3 –	0.54	0.44
6 silver-15-6	2	1.4 – 1.1 –	0.41	0.27
6 clear-15-6 (2)	2 + 3	– 1.1 – 1.1	0.61	0.39
6 clear-12-4-12-6 (2)	2 + 5	– 0.8 – 0.6	0.55	0.36
Solar shading glass (dyed through) + solar shading glass (coated incl. low- $\varepsilon$ coating)				
6 grey-15-clear 4	3	1.4 – 1.1 –	0.31	0.30
6 grey-15-silver 6	3	1.4 – 1.1 –	0.20	0.22
6 green-15-clear 4	3	1.4 – 1.1 –	0.54	0.32
6 green-15-silver 6	3	1.4 – 1.1 –	0.35	0.23

Energy glazing is a designation for glass with an emissivity  $\varepsilon < 0.2$

Energy glazing type 1: Hard low-emission coating

Energy glazing type 2: Hard low-emission coating  $\varepsilon = 0.1$   
 Energy glazing type 3: Hard low-emission coating  $\varepsilon = 0.04$

Typical U-values for window frames are given in table 3.

Table 3. Heat transmission coefficients for typical window frame constructions.

Material	Description	$U_f$ [W/m <sup>2</sup> K]
Wood	30 mm frame width (spruce or pine)	2.3
	85 mm frame width (spruce or pine)	1.6
	135 mm frame width (spruce or pine)	1.2
Plastic	PUR-profiles	2.6
	2-chamber PVC-profiles	2.1
	3-chamber PVC-profiles	1.9
Metal	Profiles without broken thermal bridge	5.9
	Profiles with broken thermal bridge	Calculation

Typical linear thermal transmittances for spacer profiles are given in table 4.

Table 4. Linear thermal transmittance for spacer profiles.

U-value of glazing unit	Linear thermal transmittance, $\Psi_g$
W/m <sup>2</sup> K	W/mK
1.0 – 1.2	0.10
2.7 – 3.0	0.07

### Window/wall joint / Thermal bridges

The installation position of a window can make a significant difference in the energy performance of the entire window. The efficiency of energy-saving, highly insulating windows can be reduced if they are installed in the wrong way. That the position of the windows in new buildings should be integrated into the insulation level is already standard and is realized in many cases. However, when renovating historical windows, the location or the level of thermal improvement must be considered and evaluated, depending on the situation and renovation measure. Well-intentioned thermal improvements of the windows can even lead to a reduction of the surface temperatures in the inner reveal area in certain situations (figure 1 and 2).



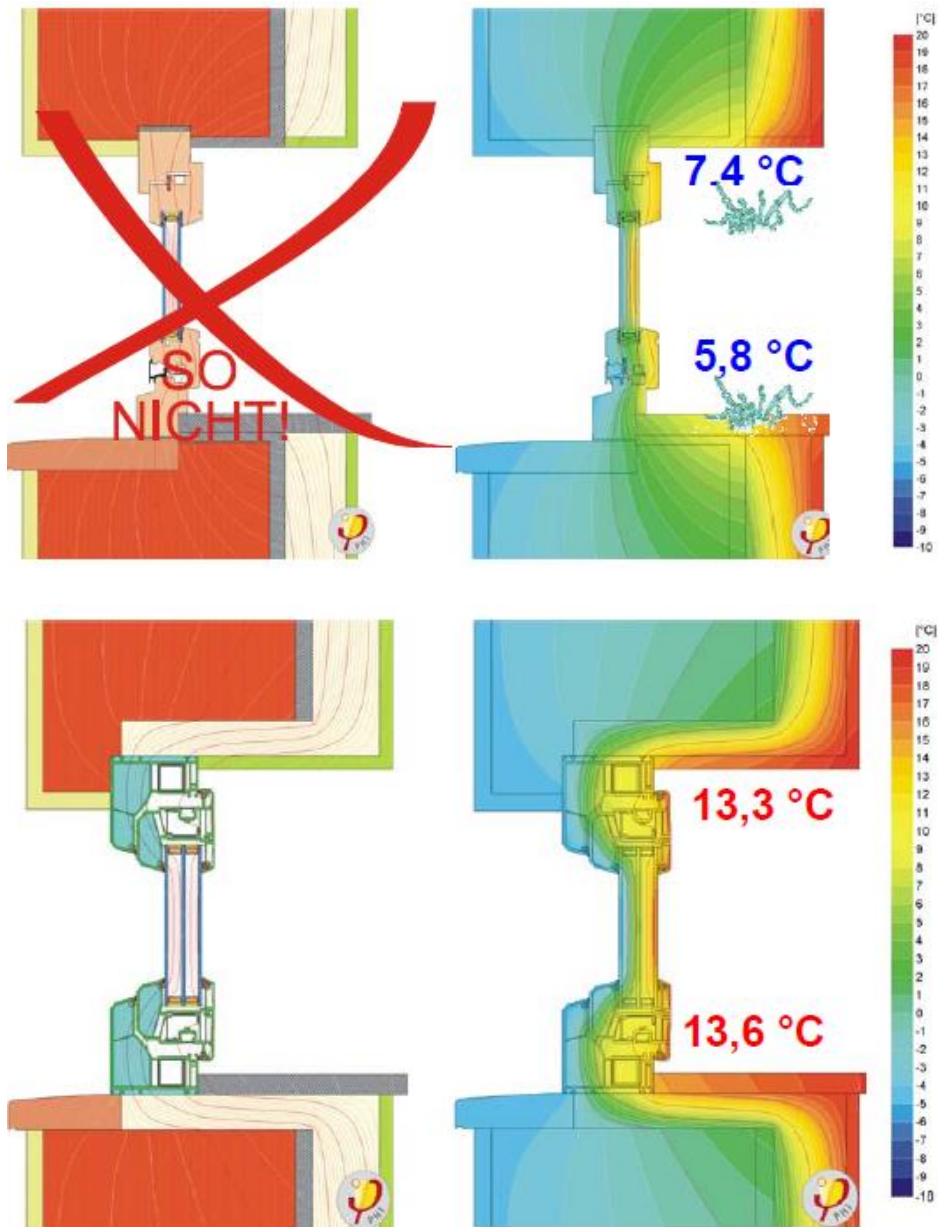

figure 1: Isothermal profile with and without insulation of the reveals in the case of internal insulation. Source: Passivhausinstitut

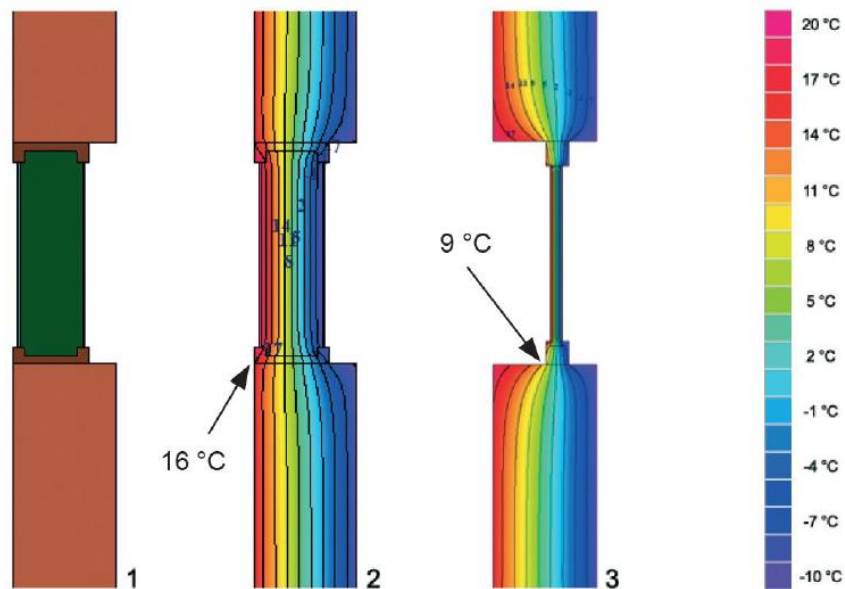

figure 2: Isothermal curve of a box-type window in comparison with an unfavourably placed modern window.  
Source: Dipl.-Ing. Dr. Karl Torghelle

## 2.2 Introduction

There are basically three different typical starting situations; Single window, coupled window or box-type window.

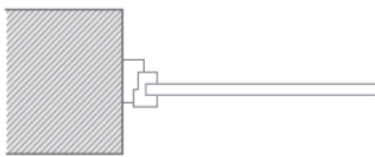

Figure 3: Single window

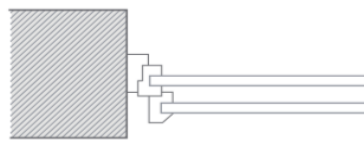

Figure 4: Coupled window

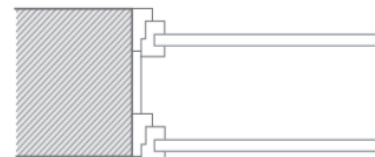

Figure 5: Box-type window

Here a short description of these three situations:

**Single window:** The single window consists of a single window layer, in historical windows with single glazing. The frame is usually made up of frame and a window sash, whereby it is quite possible to have more than one openable casement. Single windows were mostly installed in rooms with low comfort requirements and on the courtyard side, which is hidden from the public. They were the most cost-effective window construction.

**Coupled window:** The coupled window also consists of only one single window layer. In comparison to the single window, however, a second single window is fixed on the inner side of the window frame. Both windows are firmly connected and can be opened at the same time. To clean the inside of the window, there is usually an opening mechanism, with which the frames can be separated from each other. In the space between the two single windows there is a standing layer of air. Composite windows became more popular towards the beginning of the 20<sup>th</sup> century.

**Box-type window:** The box-type window consists of two window layer which are fixed one after another at a certain distance. In the space between the panes, the inner and outer windows are connected with a wooden board. Respect to the single window they have improved thermal insulation properties, due to the second window level and the air space between them.

A total of 15 solutions are described in the following chapters. An overview of the solutions is given in table xx. The solutions are grouped into four sub-groups based on the level of the impact they have on the visual appearance of the building; solutions with low impact, solutions with impact on the appearance from the inside, solutions with impact on the appearance from outside and finally solutions with an impact on the whole window.

Table 5.: Solutions for window refurbishment and energetic enhancement, sorted from low to high impact

No	Solutions with low impact
1 A	Only repairing window (LI)
1 B	Inserting a sealant (LI)
1 C	Addition of foils to the glass (LI - MI)
1 D	Repair or replace lost shutters (LI)
	<b>Solutions with impact on the appearance from inside</b>
2 A	Replacing inner glass (includes vacuum and insulation glazing) (LI - MI)
2 B	Addition of layer of glass on internal walls also covering the windows (MI)
2 C	Extra layer of glass on the inside (MI)
2 D	Addition of a new window layer (on the inside) (MI)
2 E	Replacing the window sash or window layer (on the inside) (MI - HI)
2 F	Adding solar shading inside (LI)
	<b>Solutions with impact on the appearance from outside (and inside)</b>
3 A	Replacing outer glass (includes vacuum and insulation glazing) (MI - HI)
3 B	Addition of a new window layer (on the outside) (MI - HI)
3 C	Replacing the window sash or window layer (on the outside) (MI - HI)
3 D	Adding solar shading outside (HI)
	<b>Solutions with impact on the whole window</b>
4 A	Replacing the window with a replica (HI)

## 2.3 Solutions with low impact

### 1 A: Only repairing window (LI)

Author: Élodie Héberlé (Cerema)

#### What is the solution?

This solution consists in simply repairing the window. It is a low impact solution for both energy and heritage. The final objective is to improve its airtightness (and thus, thermal comfort of the users) and its durability. It has no impact on its U-value.

#### Why does it work?

Repairing a window covers in fact several techniques: replacing a missing or a broken part of the window, adjusting the sash to the frame, removing multiple coats of paint, replacing, or adding seals between the frame and the sash, filling cracks between the frame and the wall, replacing old glazing putty between the sash and the glass.

This solution suits to heritage windows that cannot be replaced or for which identical replacement is too expensive. It also suits to buildings where it is possible to improve the energy consumption by other ways, with lower heritage impact than replacing windows. It suits finally to buildings located in places where winters are not harsh and where single glazing can be tolerated.

#### Description of the context

In Downie's Cottage, the windows were removed and cleaned and carefully renovated down back in the workshop. Due to their small size, thermal improvements were not deemed to have been effective.

#### Pros and Cons

The benefits are a very low impact on heritage. It consists in easy and unexpensive techniques that could be applied by a homeowner. It also improves thermal comfort and make the window last even longer.

The drawbacks are a very low energy impact. Joiners are sometimes not trained anymore to apply these techniques, or they do not want to apply them. And unfortunately, windows remain the coldest part of the façade (even more if the walls are insulated) and condensation could occur on the glass.

#### Type of data available

Repairing windows is recommended by several cities or institutions, for example the city of Toulouse (France) and Historic England.

<https://www.hiberatlas.com/smarteredit/projects/84/short-guide-1-fabric-improvements.pdf>

"Traditional Windows: their care, repair and upgrading", Historic England.

<https://www.hiberatlas.com/smarteredit/projects/84/menuiserie.pdf>

"Guide de la menuiserie toulousaine", ville de Toulouse.

#### Best practice example

Downie's Cottage - United Kingdom, <https://www.hiberatlas.com/de/downies-cottage--2-32.html>

Thermal properties	Existing window	Refurbished window
Window type	Single window	Single window
Glazing	Single	Single
Shading	/	/
Uw	/	/
Ug	5,0	5,0
Uf	1,4	1,4
g-value glass	0,6	0,6
Air tightness	No sealing	No sealing
Approximate installation year	1910	2015



Figure 6: Example taken from ATLAS case Downie's Cottage. Single window before and after repairing, © HES

## 1 B Inserting a sealant (LI)

Author: Dagmar Exner (Eurac)

### What is the solution?

Main aim of the window retrofit in this example was the renovation of the existing coupled windows from around 1910, the improvement of airtightness, replacement of damaged panes and the conversion of glazing to safety glass. Requirement of the heritage authority was the preservation of the entire historic window construction; replacement of damaged panes was possible. The retrofit solution foresees a low impact solution, inserting a seal into a groove all around the existing window frame. Furthermore, damaged panes were substituted, and a foil applied to the existing inner and outer glazing in order to obtain a safety glazing (regulation in public buildings).

### Why does it work?

This retrofit solution foresees a low impact solution, inserting a seal into a groove all around the existing window frame. Main aim of this solution is the improvement of airtightness, it has no impact on its U-value.

### Description of the context

Dante Alighieri School is considered as one of the most important school building in Bolzano. The architect Gustav Nolte gave the building great importance due to its comprehensive design elements in the Munich Art Nouveau style.

### Pros and Cons

#### Pros:

- preservation of the entire window construction including historic glazing.
- low impact window construction – not “visible” when the window is closed.
- Improvement of airtightness and thus reduce of uncontrolled ventilation heat losses and improved comfort through less draught.

#### Cons:

- very low effect on energy efficiency - the solution does not improve the thermal transmittance of the window.
- windows remain the coldest part of the façade and condensation could occur on the glass.
- Impact on the historic window construction, especially when the sealant is inserted into a milling all around the existing window frame (not reversible)

#### Innovation:

Application of a safety film on both window levels class 1B1 and 2B2 as it is mandatory for public buildings in Italy. the foil works simultaneously as thermal protection film.

### Type of data available

Information available: Photos, digital drawings after measurement (views from inside and outside, horizontal section), description, heritage value assessment (before retrofit), thermal simulation in Framesimulator, Uw-value calculation, evaluation of conservator afterwards

(Factsheet project PlanFenster)

Thermal properties	Existing window	Refurbished window
Window type	Coupled window	Coupled window
Glazing	Inner window: 3 mm single Outer window: 2 mm single	Inner window: 3 mm single Outer window: 2 mm single
Shading	Roller shutter	Roller shutter and sun protection film
U <sub>w</sub>	2,55	2,55
U <sub>g</sub>	2,79	5,0
U <sub>f</sub>	1,90	1,90
g-value glass	-	-
Air tightness	No sealing	Hose sealing
Approximate installation year	1909-1911	2009



Figure 7: Window solution at Dante School after renovation (coupled window), © Dagmar Exner.



Figure 8: Coupled window with inserted sealing in a groove all around the rabbet

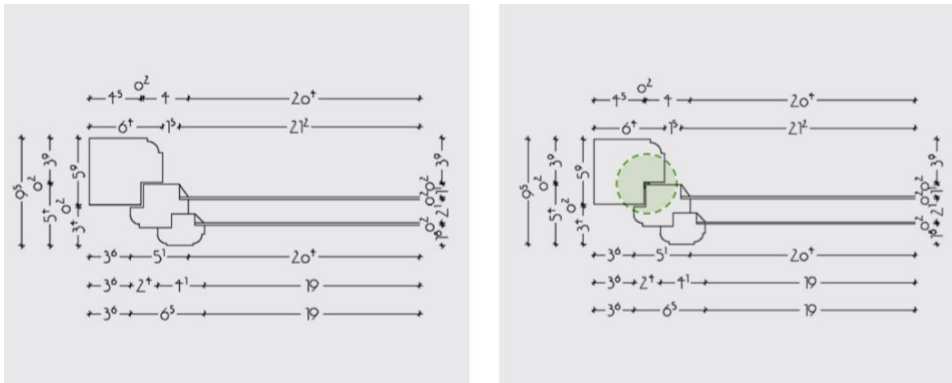

Figure 9: Horizontal section before and after retrofit

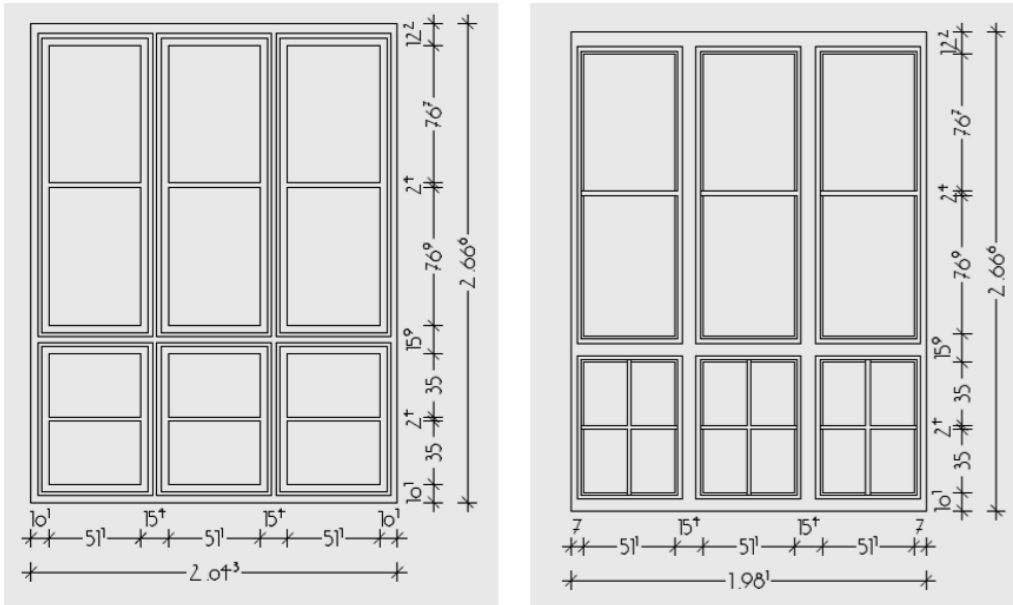

Figure 10: Coupled window: interior and exterior view

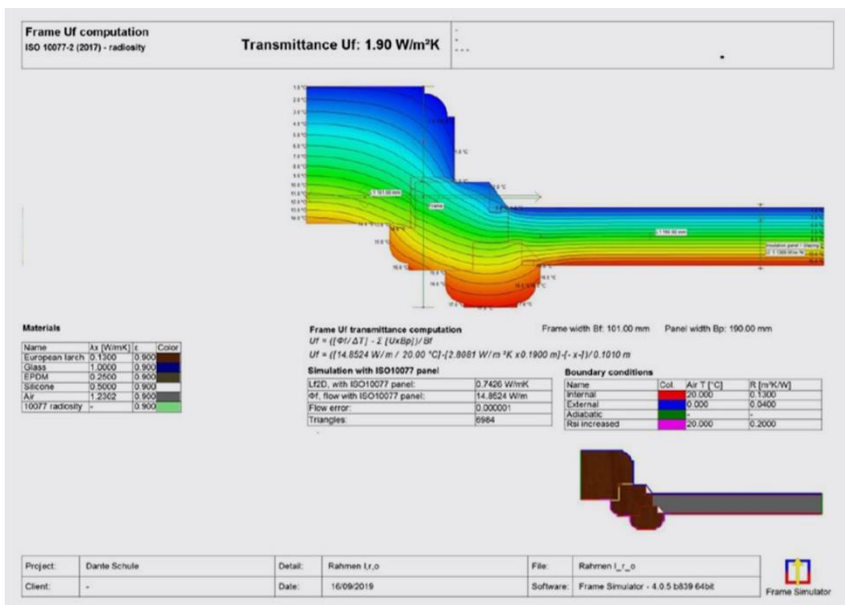

Figure 11: Calculation of Uf-value

## 1 C Addition of foils or coatings to the glass (LI-MI)

Author: Dagmar Exner (Eurac)

### What is the solution?

Enhancing the glazing properties by applying a foil to the glazing. Films are used to upgrade existing historical glass for safety reasons. By coating the existing glass with insulating or heat protection films, also the thermal properties of the glass can be improved. The applied foils in this case work like the coatings in case of heat protection or insulating double or triple glazing, only that they are applied afterwards to the existing glazing.

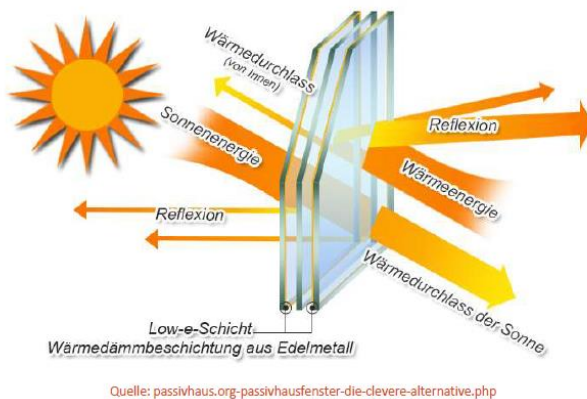

Figure 12: Function scheme of coated triple glazing

Low-E glass is the abbreviation for low-emissivity glass (= low heat radiation) and refers to an insulating glass to which a wafer-thin metal layer of about 100 nm is applied. This reduces the emissivity of the glazing and serves as a thermal and/or solar control layer. The structure of the coating as well as its technical and optical properties can vary depending on the type of coating.

### Why does it work?

Safety regulations can be a reason to substitute historic glazing, e.g., in public buildings in Italy building regulations require safety glass when it comes to window retrofit. In this case the application of a foil can be a compromise and a solution to conserve and maintain valuable historic glazing. In case of solution 1B, the “Dante school building” a foil was applied to the existing inner and outer glazing of the coupled window in order to obtain a safety glazing. In this case the foil has no effect on the energy efficiency of the glazing.

To improve thermal properties of the glazing, there are insulating or heat protection films on the market whose application can improve slightly the energy efficiency of the glazing by reflecting the indoor heat or can reduce excessive solar radiation into a building and thus reduce overheating.

### Description of the context

Renovation of ecological “Freihof Sulz” (Vorarlberg, Austria): Holistic redevelopment of the listed building into a lively meeting place. Due to the protection of historical monuments (see link to pdf below: a special feature (of the building) are the windows with largely cambered glass, shutters and sandstone frame) and well-preserved cambered windows, the decision was made to retain the box-type windows. Repaired and replaced using old wood material parts that were rotten, fell off or were infested with pests. New wood was used for large, damaged areas. Holes were filled in; irregularities were sandpapered. Old varnish was sanded off, the oil rubbed off with spirit. The windows were glazed out, the old putty was removed. With a special tool, only loose spots were sanded and then patched because otherwise, the paint would not have adhered. Afterwards, they puttied with linseed oil putty. The renewed glass was coated with a low-E coating. Partly the glass was re-glazed. In the listed rooms on the ground floor, the old, cambered glass was used. The fittings were rubbed off and after a function check they were lubricated and set up. Windows were partly machined at the bottom with a planning machine to ensure tightness. Glazing was done without silicone, instead, oil glue putty was applied with a spatula. Weather shanks were removed, and new ones made of larch wood were fitted. For sealing, sheep's wool was stuffed from the outside and grouted with acrylic. Inside, the carpenter sanded, puttied and patched the frames and checked and reattached the fittings. In some cases, holes had to be drilled on the sides and the frames screwed to the masonry. Shutters are designed to



match the sunlight. Depending on the floor, direction and use, the shutters are partly closed at the bottom and are equipped with fixed slats or adjustable slats for display. Shutters were partly in very bad condition. They were also repaired as described above.

## Pros and Cons

Pros:

- low impact on historic glazing
- can be the only solution if building regulations require safety glazing or

Cons:

- very low effect on energy efficiency
- windows remain the coldest part of the façade (even more if the walls are insulated) and condensation could occur on the glass.
- depending on the film, the appearance of the window may be altered (colouring, transparency etc.
- the solution might not be suitable for very thin historical glass with many irregularities

## Type of data available

Information available: Photos, description, heritage assessment  
<https://www.hiberatlas.com/smartedit/projects/172/Bescheid%20der%20Unterschutzstellung%202005.pdf>

Example in the HiBERAtlas for coating the glazing with a low-E coating: Freihof Sulz  
<https://www.hiberatlas.com/fr/freihof-sulz--2-172.html#section3>

Thermal properties	Existing window	Refurbished window
Window type	Box-type window	Box-type window
Glazing	Two single glazing as box-type windows	Two single glazing as box-type windows with low-e
Shading	Outer shutter	Outer shutter
U <sub>w</sub>		
U <sub>g</sub>	2,2	1,8
U <sub>f</sub>	2,0	2,0
g-value glass		0,7
Approximate installation year	1900	2006



Figure 13: Window solution at Freihof Sulz before (middle above), © Martin Rhomberg, Beate Nadler-Kopf; and after renovation (box-type window), © Lukas Schaller

Example in the HiBERAtlas for coating the glazing with a foil applied to the existing inner and outer glazing in order to obtain a safety glazing: see also solutions 1B “Dante school building” in Bolzano, Italy

## 1 D Repair or replace shutters (LI)

Author: Sara Mauri (Polimi)

### What is the solution?

Internal and external shutters are a very common technical element in the original configuration of historic buildings: they add character and aesthetic appeal to the interiors and the façade of the building. Some traditional windows have both shutter systems. These elements, simple but highly effective, have long been used to reduce thermal gains from solar radiation during the summer season, when windows receive direct sunlight, and to cut down heat losses from transmission and ventilation in winter.

The first admissible action for shutters is to repair them. Overhauling and repairing existing shutters helps to reduce energy use. Sometimes it is just enough repainting them and reintegrating or reinforcing the parts that have undergone a serious process of decay and adjusting the hardware. Where shutters have been removed but the framing and housing remains, the option of having replacement shutters custom made can be considered. A new shutter can be made according to traditional joinery techniques, preferably with wooden material, already used in the past to make historical shutters thanks to its good insulating properties. New wooden shutters can also be insulated and draughtproofing incorporated to further improve the energy efficiency of the opening system (thermal shutters). For example, Paul Baker, in the "Technical paper 1" [2], used an environmental chamber to measure the U-value of seven different retrofit measures including a traditional shutter and a modified one with a *Spacetherm* insulation blanket (with super insulating "silica aerogel" particles) of 9 mm thickness inserted into panels and covered with plywood (insulated area was 55%). Both measures had a strong impact in reducing the heat flow through the glazing. The traditional shutter showed a 51% reduction in heat loss, while insulating the panels of the shutters produced an improvement of 60% and a U-value equivalent to low emissivity double glazing.

### Why does it work?

The performance of shutters in reducing energy use for heating and cooling is a function of the style, type and size. Generally speaking, in the cold season external shutters slightly reduce the night-time heat losses preventing leak of the accumulated heat during the day. In the warm season they help to mitigate summer overheating: during the day they are closed when there is a greatest sun exposure, and then they are reopened in the evening to favour the leak of accumulated heat. Internal shutters, on the other hand, have the function of insulating the window during the cold season, maintaining heat inside the building. These are not very effective in reducing summer heat gain because they intercept solar radiation only after passing through the glass pane. Both types of shutters, once closed, improve users' safety, privacy and the U-value of the window, but they block the incoming natural daylight. In addition, shutters can also help to reduce external noise levels. From the conservation point of view, repair or replace lost shutters does not involve a loss of historic character: it is therefore a low impact solution for the heritage.

### Description of the context

Examples are not available.

### Pros and Cons

Pros: cheap solution if shutters are already installed; external shutters protect against both solar gain and heat loss and provide security and weather protection; internal shutters are good at reducing heat loss but are less effective against heat gain; they increase the thermal resistance of the window; they improve users' safety and privacy; they offer reasonable noise protection; they improve thermal comfort in hot climates and summer seasons; they improve solar control of the façade (higher for external shutters and lower for internal shutters); very low impact on heritage.  
Cons: closed shutters preclude the entrance of natural light; lack of privacy when shutters are open.

### Type of data available

There are no data available.

## 2.4 Solutions with impact on the appearance from inside

### 2 A Replacing inner glass (includes vacuum and insulation glazing) (LI-MI)

Author: Dagmar Exner (Eurac)

#### What is the solution?

This method can only be used for constructions with several window layers (one behind the other), such as coupled or box-type windows. The historic window construction including window frame and outer glazing is conserved and restored. The solution foresees to replace the historical inner usually single glass panes with insulating glass or vacuum glazing. In order to fit insulating glazing, the rabbet and/or frame of the inner window often has to be enlarged on the outer side with a wood lath. This medium impact solution is combined with 1B. The Ug-value can be improved significantly and the historical appearance from outside can be preserved. It must be ensured that the existing hinges can bear the additional weight of the new glazing.

In the case of the windows of the Knablhof, the historic window construction consisted of box-type windows from 1930/34. Airtightness of the windows was improved by milling a groove and integrating a seal on the inner side of the window frame. To reduce transmission heat losses, the single glazing of the inner window sashes was substituted by a double-glazing. So that the historical narrow frame can hold the thicker glazing pane, it was reinforced on the outside by a wooden strip (see drawing). The insulating glazing was fixed again on the outside with putty (of linseed oil). The window frames were restored on-site by renewing the paint with linseed oil. The outer window sashes are painted with linseed oil paint in ochre according to the specifications of the monument office, while the inner window sashes are not painted with linseed oil paint as there is a risk that the linseed oil could damage the butyl of the insulating glass. Damaged outer panes were repaired with intact historical inner panes. Thus, all exterior windows have exclusively historical glazing.

When renovating the box window with this method, care must be taken to ensure that the seal of the inner window is done in an accurate way. At the same time, the outside window must be well ventilated enough to be able to remove moisture in the space between the panes. If room air enters the window cavity, the risk of condensation is high. The window manufacturer used a system from Zoller-Prantl for the renovation. The special gaskets patented by the company enable even warped window frames to be closed completely airtight. Thus, no humidity can penetrate the interior of the box window.

#### Why does it work?

**Conservation:** The retrofit solution corresponds to the requirements of the heritage authority preserving the historic window construction and respecting all other criteria on color and proportions. Visual changes were foreseen only on the inner view on the window: the replacement of the historic single glazing in the inner window sashes into the thicker double-glazing with better energy performance required the enlarging of the inner window frames with a wooden strip. Besides that, the float double-glazing has another optic than the historic glazing. The integrated seal on the inner side of the window frame is only visible when the inner window sashes are open. Thus, the window appearance and proportions did not change at all from the outside and only slightly on the inside. **Moisture safety:** The window construction after retrofit is generally moisture safe. Through the double-glazing in the inner window sashes, we have higher surface temperatures on the pane and thus less condensation risk. Surface temperatures in the angle between window frame and reveal are already higher in case of a box-type window. In case of the Knablhof interior insulation in the window reveal, avoids additionally condensation all around the window frame. The window manufacturer used special seals and a special manufacturing of the grooves which make it possible to make even slightly warped window frames completely airtight. Thus, no vapor can penetrate into the intermediate space between the two-window layer and condensate on the inner surface of the outer glazing. **Energy improvement:** Ventilation heat losses through leaky windows were decreased by improving the airtightness through a seal on the inner side of the window frame and between the two inner window sashes. Transmission heat losses were decreases by the exchange of the inner glazing into a double-glazing ( $U_g = 1,10 \text{ W}/(\text{m}^2\text{K})$  after;  $U_g = 5,75 \text{ W}/(\text{m}^2\text{K})$  before); the overall  $U_w$ -value was thus improved from  $2,36 \text{ W}/(\text{m}^2\text{K})$  to  $1,26 \text{ W}/(\text{m}^2\text{K})$ .

#### Description of the context

The Knablhof is a residential house located in Mareit in South Tyrol (North Italy) on a sea level of about 1.000 m. The building is very characteristic for the village. Built in 1819 it is one of the oldest buildings of the village in the village centre. It was built as former chandlers' house with a connected barn and stable. Before the renovation, the house was uninhabited for 40 years. The heritage preservation office has formulated clear requirements for the building, which is under monument protection, which were taken into account during the retrofit. Conservation

requirements with regard the windows: “Preservation of the historic window construction, (an energetic upgrading is possible): wooden windows with sash bars and slender window frame dimensions, drip sill (Wetterschenkel) on the below side of the frame in wood. Window colours in ochre with linseed oil paint, preservation of room layout, retention of size and frame proportions, replacement of one window into a window door is possible.”

### Pros and Cons

Pros: - in case of a box-type window the two window layers allow to intervene on the inner window layers for energy enhancement, the view from outside can be completely preserved - with this solution great parts of the window construction can be preserved (all wooden parts) and is only slightly changed. Historic glazing on the outer window layer is preserved, too. - at the same time energy performance can be improved significantly (Uw-value after retrofit 1,26 W/(m²K))

Cons: - the inner (energy efficient) window layer has to be widely airtight - the seal has to compensate also uneven or slightly curved window frames - the outer window layer has to be "untight" or well ventilated enough - both in order to avoid condensation risk on the outer window layer

### Type of Data Available

Information available: Photos, digital drawings after measurement (views from inside and outside, horizontal section), description, heritage value assessment (before retrofit), thermal simulation in Framesimulator, Uw-value calculation, evaluation of conservator afterwards

### Best practice example

Knablhof – Mareit, Italy

(Factsheet project PlanFenster)

Thermal properties	Existing window	Refurbished window
Window type	Box-type window	Box-type window
Glazing	Inner window: single glazing Outer window: single glazing	Inner window: double glazing Outer window: single glazing
Shading	Without/window shutters	Without/window shutters
Uw		
Ug	5,0	5,0
Uf	1,4	1,4
g-value glass	0,6	0,6
Air tightness	No sealing	Zoller-Prantl sealing
Approximate installation year	1819, 1930-34	2017



Figure 14: South view before and after retrofit, © Elmar Gruber



Figure 15: West view before and after retrofit, © Elmar Gruber



Figure 16: Knablhof (box-type window) – before and after renovation, © Darius Richter



Figure 17: Knablhof (box-type window) – view from inside after renovation, © Darius Richter



Figure 18: Knablhof (box-type window) – details after renovation, © Darius Richter

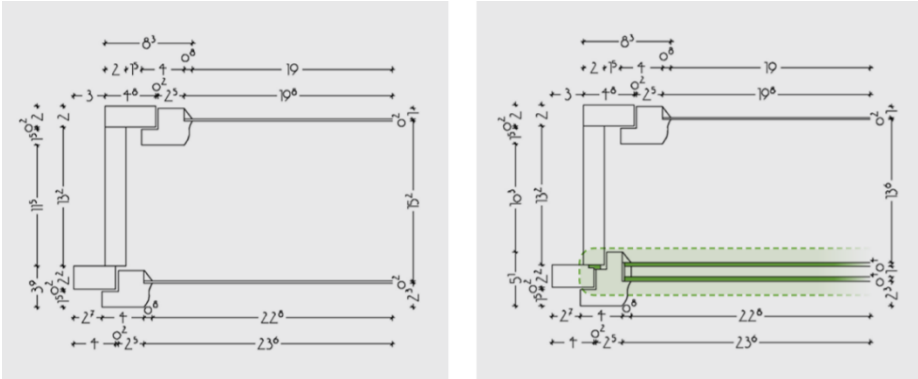

Figure 19: Horizontal section before and after retrofit

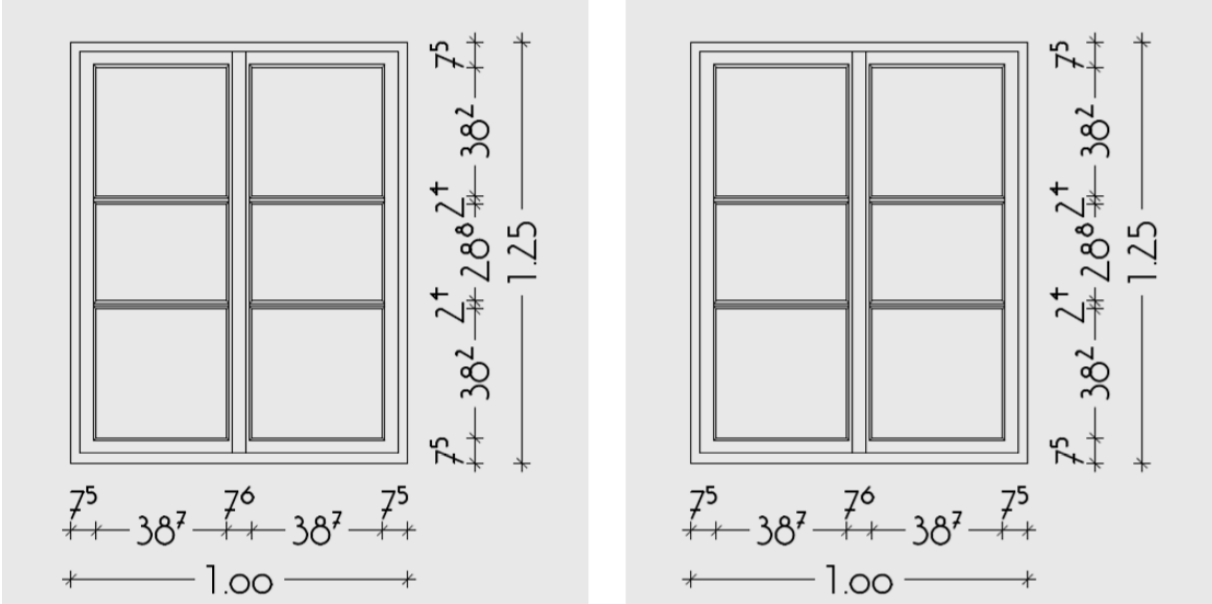

Figure 20: Coupled window: interior and exterior view

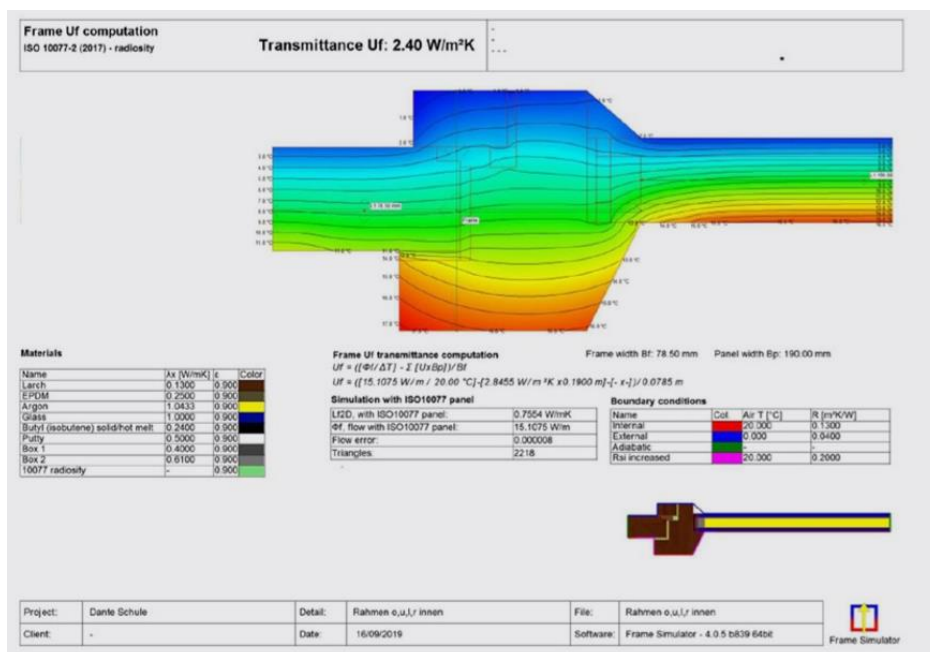

Figure 21: Calculation of Uf-value of the inner window sash after retrofit

## 2 B Addition of layer of glass on internal walls covering also the windows (MI)

Author: Jørgen Rose (Aalborg University)

### What is the solution?

In order to improve the energy efficiency of the protected façade of the building, a single layer of glass was installed on the inside of the existing façade. The glass goes from floor to ceiling. Below and above the existing windows, insulation is added to improve the U-value of the walls (in this specific case 50 + 25 mm insulation is added to the wall). The vertical cross section shows the details of the specific solution. The solution is a medium impact solution. It preserves the façade of the building from the outside but involves significant changes on the inside. From the outside the change is not readily visible. In this specific case LED-lights were added between the new layer of glass and the original windows. The building is used as a culture center and the lights act as a way to emphasize the façade in different ways by altering the colors – this can be utilized depending on the events taking place inside.

### Why does it work?

The extra layer of glass makes the solution vapor tight from the inside, i.e., warm moist air cannot get to the colder surfaces of the original façade. This, of course, means that connections in the inside glass layer must be sealed with great care. The inside layer of glass goes from floor to ceiling avoiding any complex joints between wall and window, i.e., insulation is added to the inside of the wall and the glass covers the insulation as well as the original window areas. As such, the solution is compatible with the specific case concerning conservation, has a high level of moisture safety and reduces heating requirements significantly. An added benefit is the improvement of the indoor climate since the solution significantly reduces draft and cold surfaces for the users.

### Pros and Cons

The pros of the solution are that the intervention is conservation compatible, has a high level of moisture safety (but requires professional workmanship), significantly reduces heating consumption, and improves indoor climate. The cons are the intervention cannot be used for operable windows, may not be sound from a building physics point-of-view in hot climates, and significantly alters the inside of the building.

### Best practice example

Osramhuset (The Osram Building), Denmark - <https://www.hiberatlas.com/en/osramhuset-the-osram-building--2-16.html>

	Existing window	Refurbished window
Type	Single window	Single window + glass layer
Glazing – Inner		
Glazing - Outer		
Shading/shutters		
$U_{\text{window}}$	5.9	1.2
$U_{\text{glazing}}$		
$U_{\text{frame}}$		
g-value	0.86	0.50
Air tightness		
Installation year	1953	2009

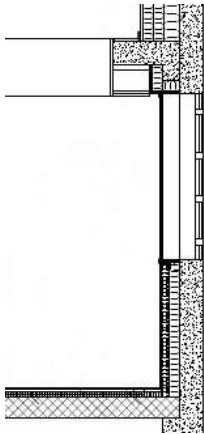

Figure 22: Vertical section, © Wissenberg A/S



Figure 23: Left: Glazing layer added to inside of wall/window. Middle/Right: LED-lighting adds possibilities, © Wissenberg A/S

## 2 C Extra layer of glass on the inside (MI)

Author: Jørgen Rose (Aalborg University)

### What is the solution?

Original preservation worthy wooden windows from before 1950-60 with one layer of glass can be energy improved by adding a coupled frame with low energy glazing internally. If the window already has a coupled frame, energy improvement can be achieved by replacing the glazing in the coupled frame with new low energy glazing. Alternatively, new coupled frames can be made with room for low energy glazing. Windows with initial signs of degradation should be completely refurbished or replaced with new windows with coupled frames and energy glazing. Alternatively, the windows can be replaced by new ones taking into consideration the architecture of the house. If the window has no coupled frame to begin with, this would be considered a medium impact solution.

### Why does it work?

The extra glazing increases the internal surface temperatures, i.e., warm moist air cannot get to the colder surfaces of the original window. Therefore, the solution has a high level of moisture safety and at the same time, it reduces heating requirements significantly. An added benefit is the improvement of the indoor climate since the solution significantly reduces draft and cold surfaces for the users. The solution will typically not be visible from the outside



and it can therefore be used in many situations where maintaining the exterior appearance of the facade is necessary.

### Description of the context

This solution would typically be used in situations where the look of the original facade needs to be maintained and when the existing windows are still in good shape. The existing windows should be painted and maintained before adding the coupled frame.

### Pros and Cons

Adding a coupled frame on the internal side of the existing window will significantly lower the heat loss through windows and could, to some extent improve air tightness at the same time. This will also result in warmer internal surfaces and therefore reduce the risk of condensation, draughts, and downdraft, resulting in an overall increased comfort and better indoor climate.

### Type of data available

This solution was used in the Ryesgade 30 project. The original windows had 1 pane of glass and a U-value of 4,20 W/(m<sup>2</sup>K). The new windows had 1 + 2 panes of glass. The 2-pane section has krypton gas filling, and the total U-value of the windows is 0,89 W/(m<sup>2</sup>K).

Due to the building's status as conservation-worthy, the renovation could not change the facade expression. However, the municipality accepted that the windows were replaced with new windows that were constructed like the old windows. The new windows were specially developed for the project with drawn glass in the outer layer of the pane to give the window the same expression and mirroring quality as the original ones from 1896.

### Best practice example

Ryesgade 30 A-C - Copenhagen, Denmark – <https://www.hiberatlas.com/de/ryesgade-30-a-c--2-143.html>

	<b>Existing window</b>	<b>Refurbished window</b>
<b>Type</b>	Single window	Single window coupled with new low energy glass
<b>Glazing – Inner</b>		Double
<b>Glazing - Outer</b>	Single	Single
<b>Shading/shutters</b>		
<b>U<sub>window</sub></b>	4.2	0.89
<b>U<sub>glazing</sub></b>	5.8	0.8
<b>U<sub>frame</sub></b>	2.3	2.3
<b>g-value</b>	0.86	0.50
<b>Air tightness</b>	Single sealing	Double sealing
<b>Installation year</b>	1953	2009



Figure 9: Left: Before renovation, the windows gave rise to condensation, draught and had a very negative effect on the indoor climate. Right: After the renovation, the new windows improved indoor climate significantly (Source: Leif Rönby).

## 2 D Addition of a new window layer (on the inside) (MI)

Author: Dagmar Exner (Eurac)

### What is the solution?

This method can only be used for constructions with a single window plane, such as single or coupled windows. In order to preserve the external shape of the building, an additional window layer, consisting of double or triple glazing, can be installed on the inside of the historical window construction. The single window thus becomes a kind of box-type window, whereby the window layers do not necessarily have to be connected to each other. If from heritage point of view there is the requirement, that the addition of the window on the inside is not visible from the outside at all, this solution can be adapted accordingly.

### Why does it work?

With this solution a single window can be improved significantly from energy point of view – the new window on the inside can be a high-energy-efficient triple glazed new window. The advantages of this method of renovation are, in particular, the good seal, which can be easily achieved, the avoidance of complications in terms of moisture protection when installed correctly and the possibility of improving the thermal bridge at the window-wall connection. Meanwhile, the outer, historical window plane remains almost untouched and can thus be preserved and the historic appearance of the façade can be maintained.

### Description of the context

Restoration of a century-old building whose façade dominates the historic village centre of Welsberg in the Puster Valley. The early reconstruction measures that had been carried out were removed. Today the building contains three flats with a total volume of approx. 1500 m<sup>3</sup>. The entire refurbishment measure was carried out radically. The building was completely gutted, even the floor slabs were demolished and replaced by a steel construction. The 60 cm thick outer walls in stone masonry were insulated on the inside with XPS panels. In front of it, an independent timber construction with wood fibre insulation was placed. The old windows were left in the façade in order to keep the historic appearance. They were simply repainted in their former orange-red colour. In order to meet the energy standard, new windows were installed behind the old windows. For the comfort of the living area, a ventilation system and underfloor heating was installed, and the heating system was connected to the district heating network.

### Pros and Cons

The pros of the solution are: high impact on energy efficiency of the window construction, Improves indoor climate (higher surface temperature, less draught) and possibility of improving the thermal bridge at the window-wall

connection when installed correctly and preferably in connection with internal insulation. The cons of the solution are significantly impact on the inside of the building.

#### Type of data available:

Information available: Photos, Klimahaus award winner from 2015 – description available

<https://www.archilovers.com/projects/110041/wohnhaus-polt.html>

<http://www.raum.it/projekte-out-p3-30.html>

<https://www.klimahaus-awards.it/de/archiv-uebersicht/kandidaten-2015-47.html>

<b>Thermal properties</b>	<b>Existing window</b>	<b>Refurbished window</b>
Window type	Winter window	Winter window with new window layer on the inside
Glazing	Inner window: single glazing Outer window: single glazing	Inner window: triple Outer window: single glazing
Shading	No window shutters	No window shutters
U <sub>w</sub>		
U <sub>g</sub>		
U <sub>f</sub>		
g-value glass		
Air tightness	No sealing	New window with sealing
Approximate installation year		

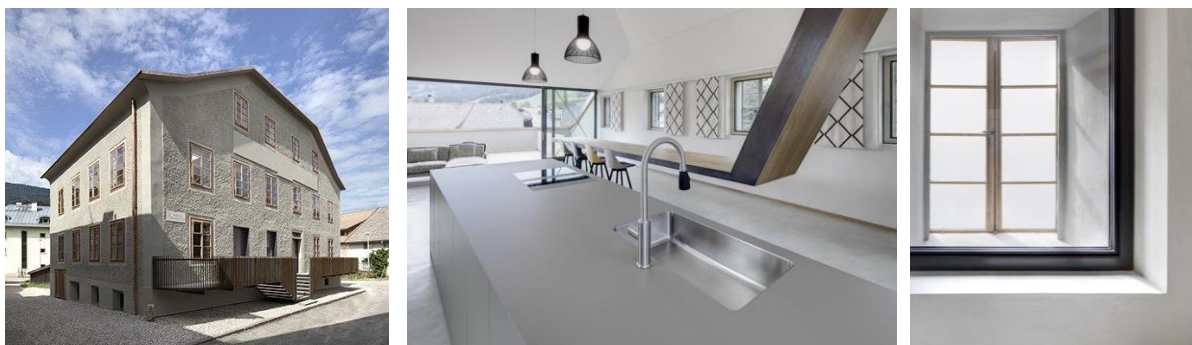
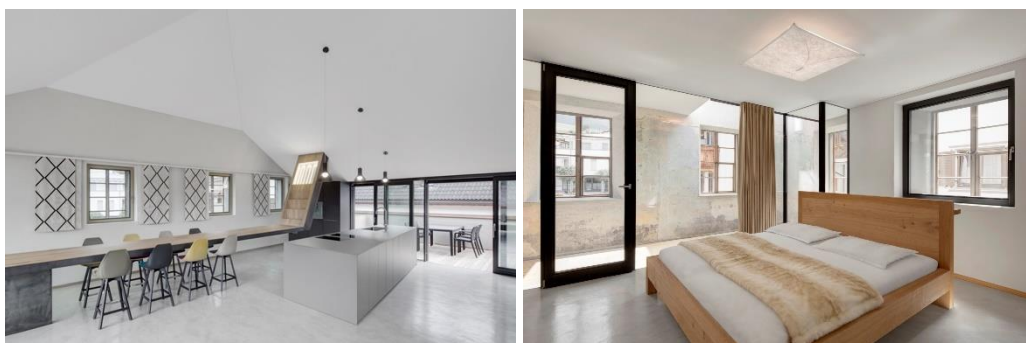

Figure 24: Residential house Pölt (single window) – after renovation

Source pictures: <https://www.archilovers.com/projects/110041/wohnhaus-polt.html>

<https://www.klimahaus-awards.it/de/archiv-uebersicht/kandidaten-2015-47.html>



Source pictures: <https://oberstaller.it/de/projekte/wohnhaus-poelt/>

## 2 D Addition of a new window layer (on the inside) (MI)

Author: Alexander Rieser (UIBK)

### What is the solution?

The solution involves the installation of a new modern window on the inside of the historic window and therefore does not affect the appearance of the façade in any way. The window was installed on a log wall that was newly built inside. Between this "new" log wall and the old wooden log building a sheep wool insulation was installed. The old wall with original windows was left and the new window was integrated into the newly created airtight level.

### Why does it work?

By installing a modern window with a U-value for the glass of 0.6 W/(m<sup>2</sup>K) and for the frame of 1.55 W/(m<sup>2</sup>K), the energy efficiency is significantly increased and lies energetically behind a window area in a passive house only due to the losses of the installation situation. However, this could still be optimised by placing the window in the insulation level. Since the window is slightly larger than the original window, the window opening looks almost like a picture that preserves the entire installation situation and appearance of the historical window. Furthermore, the incidence of light is optimized by the larger internal window. From the outside the original optics remains unchanged. To avoid condensation between the windows, it is important that the space between the windows is ventilated to remove the diffusing moisture. The old window therefore no longer has an energetic function but acts as protection against driving rain for the construction behind it.

### Description of the context:

Especially with old rural buildings the topic of window openings is very delicate. If you follow the history of the development of timber construction, it quickly becomes clear that openings in the façade were difficult to integrate, especially in log construction. The main problem was the movable connections of windows to the wooden beams. Settlements and effects of shrinkage and swelling of the wood had to be compensated by these connections.

### Pros and Cons:

The main advantage of this solution is certainly the unrestricted original appearance of the façade as well as the energy-efficient renovation of the window opening. Also, the complete comprehensive preservation of the window as well as the installation situation of the window, are a great solution. However, such a solution must fit into the overall concept of the renovation. If, for example, there are special paintings in the interior which must be preserved or there are other reasons which contradict an interior insulation, the solution cannot be realized.

### Best practice example

Giatla House - Innervillgraten, Austria – <https://www.hiberatlas.com/en/giatla-house--2-212.html>

<b>Thermal properties</b>	<b>Existing window</b>	<b>Refurbished window</b>
Window type	Box-type window	new window layer on the inside
Glazing	Inner window: single glazing Outer window: single glazing	Inner window: triple glazing
Shading	Without/window shutters	Without/window shutters
U <sub>w</sub>		
U <sub>g</sub>	2,2	0,6
U <sub>f</sub>	2,5	1,55
g-value glass		
Air tightness	No sealing	New window / RAL Installation
Approximate installation year	1600 - 1700	2017



Figure 25: New opened window with the original window behind, ©Pavel Sevela



Figure 26: View from the inside, ©Madritsch & Pfurtsceller



Figure 27: View from outside, ©Lukas Schaller

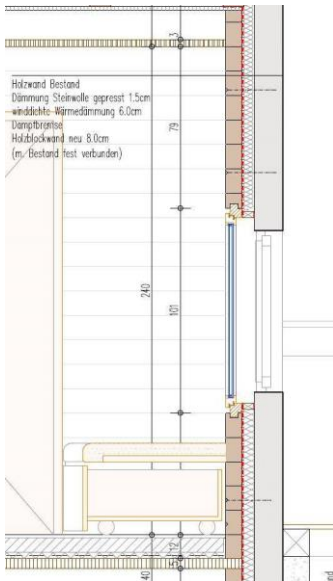

Figure 28: Facade cut of the window, ©Madritsch & Pfurtsceller



Figure 29: View from inside, ©Lukas Schaller

## 2 E Replacing the window sash or window layer (on the inside) (MI-HI)

Author: Élodie Héberlé (Cerema)

### What is the solution?

The solution consists in replacing the sash of an existing single window, while the existing frame is not affected. It is a middle impact for both heritage and energy, especially if the existing window was repaired before the replacing of the sash. In the case of box-type or coupled windows, another solution is to replace the inside window layer on the inside.

### Why does it work?

Every type of sash and glass is possible. Single-glazed glass suits to heritage windows that need to be repaired. This glass, even if single-glazed, could also be a more technical glass than the original: protective glass or insulating simple-glazing (see [www.van-ruysdael.com/](http://www.van-ruysdael.com/)). Double or triple-glazed glass is possible when the new sash and the existing frame can support the additional weight of the glass. Any type of filling or coating is possible between the glass layers.

### Description of the context

In Klostergebäude Kaiserstrasse, the outer wings of the box windows in listed facades were renovated and on the inside a new wooden window with special interior insulation was added. The solution sets the new inner wing completely flush with the inner wall and improves the thermal situation through internal insulation and reveal insulation. The sunshades are positioned between the wings in the lintel in existing roller blind niches. This layout represents a novel solution for old buildings.

### Pros and Cons:

The benefits of this solution are a middle impact on energy. It also improves thermal comfort, and the risk of condensation is low. The drawbacks are a middle impact on heritage: the proportions, the materials, the presence of glazing bars must be well considered. Joiners are sometimes not trained anymore to apply these techniques, or they do not want to apply them. This solution is also quite ineffective if the existing window was not repaired before the replacing of the sash. Finally, the new sash and the existing frame must be able to support the additional weight of the glass.

### Type of data available:

/

### Best practice example

Klostergebäude Kaiserstrasse - Wien, Austria – <https://www.hiberatlas.com/en/klostergebäude-kaiserstrasse--2-35.html>



Figure 30: Klostergebäude Kaiserstrasse (box-type window) – before and after renovation, © Courtesy of Trimmel Wall Architekten ZT GmbH



Figure 31: Replacing of inner window layer, © Courtesy of Trimmel Wall Architekten ZT GmbH

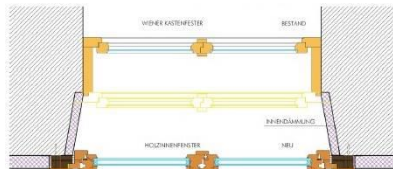

Figure 32: Horizontal section, © Courtesy of Trimmel Wall Architekten ZT GmbH

Thermal properties	Existing window	Refurbished window
Window type	Box-type window	Box-type window
Glazing	Single on the outside and single on the inside	Single on the outside and double on the inside
Shading	/	/
U <sub>w</sub>	/	/
U <sub>g</sub>	5,0	1,2
U <sub>f</sub>	2,3	2,3
g-value glass	0,9	0,6
Air tightness	No sealing	No sealing
Approximate installation year	/	/

## 2 F Adding solar shading inside (LI)

Author: Sara Mauri (Polimi)

### What is the solution?

Traditional options for improving windows thermally are the insertion of internal solar shadings like shutters, blinds, and curtains. Shutters and curtains are very common technical element in the original configuration of historic buildings, while blinds are recent elements and, in some cases, considered incongruous in historic buildings field from a typological, constructive, and energetic point of view. The latter therefore require careful design. All these systems can result in significant reductions in thermal gains from solar radiation during the summer and in heat loss in winter, with no impact on existing window fabric. Well-fitted internal wooden shutters can decrease heat loss from both draughts and conduction through the window by up to 51% [2]. Curtains, on the other hand, can control draughts and reduce heat loss by 14% [3], but care must be taken to ensure they do not obstruct radiators. It is evaluated that the combination of these systems can reduce heat loss by as much as 62% [3]. Various range of solar shading with a variety of insulating and reflective layers are also available to further improve the energy efficiency of the opening system. An example for the internal side would be the modern insulated heavy lined curtains or reflective and/or insulated blinds. Some tests, discussed in the Historic England guidance “Traditional Windows: their Care, Repair and Upgrading” [4], have shown that heavy curtains or ordinary blinds cut heat loss by around 40%; honeycombed roller blinds (made of much lighter materials, but with a cellular structure that traps air) cut losses by more than 50% and blinds with reflective surfaces on the window side have been found to cut losses by as much as 57%. In general, this intervention requires a careful evaluation of the compatibility with the building envelope, the local climatic variables, the building exposure, the orientation of the glass surfaces and the intended use of the building.

### Why does it work?

The performance characteristics of solar shading depends on the type: shutters, blinds, or curtains. Internal shutters have the function of insulating the window during the cold hours, maintaining heat inside the building. These devices help to increase the thermal resistance of the window creating an additional ventilated air gap between the window and the solar shading. However, these systems are not very effective in reducing summer heat gain because they intercept solar radiation only after passing through the glass pane. Internal shutters, once closed, improve users' safety and privacy, but they block the incoming natural daylight. In addition, they can also help to reduce external noise levels.

The internal curtains and blinds, instead, have the purpose of mitigating the incidence of light radiation, distributing the light in space, and avoiding glare. If curtains are made with a heavy fabric, they reduce heat losses caused by conduction, proving to be a good insulation system. They are also an excellent way of preventing draughts. The internal curtains should be set from floor to ceiling because even a small gap of few millimetres at the base of the curtain causes a leakage of cool air, hence affecting its functioning [5]. Like the internal shutters, they do not offer any protection against radiation because they intercept sun's rays after passing through the glass surface. From the point of view of conservation, the addition of solar shading does not affect the historical material consistency and does not distort building characteristics so, if well designed, it is respectful of heritage.

### Description of the context

Examples are not available.

### Pros and Cons

Pros: internal shutters are good at reducing heat loss but are less effective against heat gain; internal shutters increase the thermal resistance of the window; internal shutters improve users' safety and privacy; internal shutters offer reasonable noise protection; internal curtains and blinds avoid glare; internal curtains and blinds distribute light in the indoor environment; internal curtains and blinds improve the conditions of visual comfort in indoor environments; internal curtains and blinds would usually be used anyway; internal curtains and blinds are cheap options to upgrade; internal curtains can provide excellent draught-proofing; low impact on heritage. Cons: closed shutters preclude the entrance of natural light; lack of privacy when shutters, curtains and blinds are open.

### Type of data available

There are no data available.

## 2.5 Solutions with impact on the appearance from outside (and inside)

### 3 A Replacing outer glass (includes vacuum and insulation glazing) (MI - HI)

Author: Jørgen Rose (SBI)

#### What is the solution?

If the historical glazing is damaged, if it is not possible to install an additional window level or if the standard requires the use of safety glass, the historical glazing must be replaced. As this is destroyed in the process, the method should only be used if the steps already described are not enough to meet today's requirements. After removing the window putty, a new insulating or thermal insulation glazing can be installed. It is important to ensure that the new glazing is adapted to the historical window construction with mullions, transom and skylight. The renovation of the single window results in the greatest energy savings in comparison. If the window construction is to be retained as a single window construction, the replacement of the historical glazing is often unfortunately unavoidable.

#### Why does it work?

Replacing the outer glazing in the window can be done using different types of glazing. If the renovation requires as little change as possible to the appearance of the building from the outside, the new glazing should as far as possible be the same as the original. In this case, the new solution will have the same characteristics regarding energy as the original solution, however there may be an increase in the overall air tightness of the building.

If slight changes to the appearance are acceptable the replacement glazing can be chosen as thermal insulating glazing, e.g., a slim 2-layer solution that significantly will improve the energy characteristics of the window. If the



existing window is either a box type window or has a coupled frame, the energy improvement of replacing the outside glazing with a new 2-layer glazing will be relatively low. Therefore, 2-layer solutions should generally be chosen for situations where there is only 1 layer of glazing in the original solution.

### Description of the context

Holyrood Park Lodge is a Category B listed Victorian lodge building built in 1857 in a neo-gothic style, located in a prominent position at the entrance to Holyrood Park in Edinburgh. Primarily designed for the constables who policed the Royal Park, it is bounded by the Palace of Holyroodhouse on one side and the Scottish Parliament on the other. Since 2007 the lower floor hosts visitor information and shop centre for the Holyroodhouse area.

### Pros and Cons

Pros:

Air tightness will most likely improve; Double-glazed units replacing single-glazed units will significantly improve the energy aspects.

Cons:

Replacing the glazing will alter the appearance of the building from both the outside and the inside.

In Holyrood Park Lodge the frame of the existing windows was in good condition and therefore the decision was made to keep them. The glazing was replaced by new slim-profile double-glazed units, which significantly improved the energy characteristics of the windows without changing notably the appearance. The U-value is reduced by approx. 70% while the new glazing also improves the indoor climate by removing draughts.

	Existing window	Refurbished window
<b>Type</b>	Single window	Single window
<b>Glazing – Inner</b>		
<b>Glazing - Outer</b>	Single	Double (slim-profile)
<b>Shading/shutters</b>		
<b>U<sub>window</sub></b>	4.48	1.26
<b>U<sub>glazing</sub></b>	5.8	0.8
<b>U<sub>frame</sub></b>	2.3	2.3
<b>g-value</b>	0.86	0.50
<b>Air tightness</b>	Single sealing	Single sealing
<b>Installation year</b>	1858	2017



Figure 33: Hollyrood Park Lodge (single window) – before and after renovation (Source: Historic Environment Scotland)

### 3 B Addition of a new window layer (on the outside) (MI-HI)

Author: Élodie Héberlé (Cerema)

#### What is the solution?

This solution consists in adding a new window layer on the outside of an existing single window. It is a middle impact for heritage as the existing single window stay intact and that the new one is removable but can affect the general perception of the building. It is a high impact for energy, especially if the existing single window was repaired before the adding and if the new one is a double-glazed one.

#### Why does it work?

When the heritage issue arises on the inside, the new window can be installed on the outside of the existing one. Besides, it does not imply to remove the existing window, only adding one, what increases energy efficiency of the entire installation but also the risk of condensation if best practices were not followed. The new window's material can be of any type, but for heritage buildings, wood is preferred. The glass can also be of any type and the glazing bars are not always necessary, since this solution preserves the existing window that has a heritage significance.

#### Description of the context

/

#### Pros and Cons

The benefits of this solution are a high impact on energy. It also improves thermal and acoustic comfort and has a middle impact on heritage depending on which side the heritage issue arises. It is finally equivalent to installing a new window.

The drawbacks are the risk of condensation that is high when best practices were not followed. The wall must also be thick enough to install a second window. And resulting box-type window are not easy to manipulate if best practices were not followed.

#### Type of data available

Two handbooks are available in France concerning the intervention of adding a new window layer on the outside (or on the inside).

<https://www.hiberatlas.com/smarterdit/projects/87/guide-rage-doubles-fenetres-reno-2014-04.pdf>

"Guide: Doubles fenêtres: prescription et mise en œuvre en rénovation des logements", programme RAGE

[https://www.hiberatlas.com/smarterdit/projects/87/ccdoublesfenetresrenovationlogementsrenodec18191web\\_1.pdf](https://www.hiberatlas.com/smarterdit/projects/87/ccdoublesfenetresrenovationlogementsrenodec18191web_1.pdf)

"Doubles fenêtres en rénovation de logements", programme RAGE

<b>Thermal properties</b>	<b>Existing window</b>	<b>Refurbished window</b>
Window type	Single window	Box-type window
Glazing	Single	Single on the inside and single, double or triple on the outside
Shading	/	/
Uw	/	/
Ug	5,0	1,2
Uf	2,3	2,3
g-value glass	0,9	0,6
Air tightness	No sealing	Repaired sealing for the inside window, new sealing for the outside window
Approximate installation year	/	/



Figure 34: Addition of a new window layer on the outside (N. Sandt From "Doubles fenêtres : prescription et mise en oeuvre en rénovation des logements", programme RAGE)

### 3 C Replacing the window sash or window layer (on the outside) (MI-HI)

Author: Élodie Héberlé (Cerema)

#### What is the solution?

This solution consists in replacing the sash of an existing single window, while the existing frame is not affected. It is a middle impact for both heritage and energy, especially if the existing single window was repaired before the replacing of the sash.

In the case of box-type or coupled windows, another solution is to replace the outside window layer.

#### Why does it work?

Every type of sash and glass is possible.

Single-glazed glass suits to heritage windows that need to be repaired. This glass, even if single-glazed, could also be a more technical glass than the original: protective glass or insulating simple-glazing (see [www.van-ruysdael.com/](http://www.van-ruysdael.com/)).

Double or triple-glazed glass is possible when the new sash and the existing frame can support the additional weight of the glass. Any type of filling or coating is possible between the glass layers.

#### Description of the context

/

#### Pros and Cons

The benefits of this solution are a middle impact on energy. It also improves thermal comfort, and the risk of condensation is low.

The drawbacks are a middle impact on heritage: the proportions, the materials, the presence of glazing bars must be well considered. Joiners are sometimes not trained anymore to apply these techniques, or they do not want to apply them. This solution is also quite ineffective if the existing window was not repaired before the replacing of the sash. Finally, the new sash and the existing frame must be able to support the additional weight of the glass.

#### Type of data available

/

Thermal properties	Existing window	Refurbished window
Window type	Single window Or box-type or coupled window	Single window Or box-type or coupled window
Glazing	Single Or single on the inside and single on the outside	Double or triple Or single on the inside and double or triple on the outside
Shading	/	/
Uw	/	/
Ug	5,0	1,2
Uf	2,3	2,3
g-value glass	0,9	0,6
Air tightness	No sealing	Repaired sealing Or new sealing for the outside window layer
Approximate installation year	/	/



Figure 35: Addition of a new window layer on the outside (AMCC From <https://www.maisonapart.com/edito/construire-renover/portes-fenêtres/changer-une-fenêtre-sans-depose-5609.php>)

### 3 D Adding solar shading outside (HI)

Author: Sara Mauri (Polimi)

#### What is the solution?

Traditional options for improving windows thermally are the insertion of external solar shadings like shutters, blinds, and curtains. Shutters and curtains are very common technical element in the original configuration of historic buildings, while blinds are recent elements and, in some cases, considered incongruous in historic buildings field from a typological, constructive, and energetic point of view. As a matter of fact, they can compromise the characteristics of the façade. The insertion of blinds therefore requires careful design. All these systems can result in significant reductions in thermal gains from solar radiation during the summer and in heat loss in winter, with no impact on existing window fabric. Well-fitted external wooden shutters can decrease heat loss from both draughts and conduction through the window by up to 51% [2]. Curtains, on the other hand, can control draughts and reduce heat loss by 14% [3]. It is evaluated that the combination of these systems can reduce heat loss by as much as 62% [3]. Various range of solar shading with a variety of insulating and reflective layers are also available to further improve the energy efficiency of the opening system.

In general, this intervention requires a careful evaluation of the compatibility with the building envelope, the local climatic variables, the building exposure, the orientation of the glass surfaces and the intended use of the building.

#### Why does it work?

The performance characteristics of solar shading depends on the type: shutters, blinds, or curtains. External shutters, in the cold season, slightly reduce the night-time heat losses preventing leak of the accumulated heat during the day. These devices help to increase the thermal resistance of the window creating an additional ventilated air gap between the window and the solar shading. In the warm season they help to mitigate summer overheating: during the day they are closed when there is a greatest sun exposure, and then they are reopened in the evening to favor the leak of accumulated heat. They are very effective in reducing summer heat gain because they intercept direct sunlight before passing through the glass pane and therefore have a high solar control

efficiency. External shutters, once closed, improve users' safety and privacy, but they block the incoming natural daylight. In addition, they can also help to reduce external noise levels.

External curtains and blinds, like the external shutters, prevent sunlight from reaching the glass, making them more efficient than the internal ones in terms of sun protection. However, their contribution to thermal insulation can be considered null.

From the point of view of conservation, the addition of solar shading does not affect the historical material consistency and does not distort building characteristics so, if well designed, it is respectful of heritage even if the external visual impact is not negligible.

## Description of the context

Examples are not available.

## Pros and Cons

Pros: external shutters protect against both solar gain and heat loss and provide weather protection; external shutters improve thermal comfort in hot climates and summer seasons; external shutters improve solar control of the façade; external shutters increase the thermal resistance of the window; external shutters improve users' safety and privacy; external shutters offer reasonable noise protection; external curtains and blinds avoid glare; external curtains and blinds distribute light in the indoor environment; external curtains and blinds improve the conditions of visual comfort in indoor environments; on large areas of glass external curtains and blinds can reduce both heating loads in winter and cooling loads in summer; external curtains and blinds would usually be used anyway; external curtains and blinds are cheap options to upgrade; low impact on heritage.

Cons: closed shutters preclude the entrance of natural light; lack of privacy when shutters, curtains and blinds are open; external curtains and blinds contribution to thermal insulation can be considered null; they affect the external appearance of the window.

## 2.6 Solutions with impact on the whole window

### 4 A Replacing the window with a replica (HI)

Author: Dagmar Exner (Eurac)

#### What is the solution?

This solution foresees to replace the original windows with a new window handcrafted, but energy efficient, solution to match the originals as far as possible. This means typically that the frame would be an exact replica of the original except for the fact that it was adjusted to allow for another type of glazing, i.e., double- or triple-layer low energy glazing instead of the typical single-layer glazing. The change of the glazing reduces heat losses significantly making the windows perform more or less like today's standard.

Example Public Weigh House of Bolzano: As there were no drawings from the original historic window available, the new window was based on a coupled window, thus the developed concept separates the demands and functions into two layers: one outer layer for the reproduction of the original historic window and an inner layer for high energy efficiency. In this way, it is possible to obtain the same appearance as the original historic window from outside in terms of frame dimensions, sash bars and mirroring by taking a single glazing, without any negative effect on the energy efficiency. This outer layer takes over the weather tightness. The passive house window with triple glazing is integrated in a second additional inner layer, taking over the airtightness. By rotating the frame cross section 90 degrees and by moving the centre of rotation of the fitting, a smaller frame than the conventional solution was achieved. It is positioned in a way that its frame is not visible from the outside. Following to this approach, both box type and a coupled window are executable. Additionally, it allows also preserving the original old window and just adding the second energy efficient layer (on the inside or also on the outside). Since a building historian had discovered traces of cut out impost (in some rare cases where the outer sashes the of box type window from the 1950s/60s were installed in an original baroque frame), the prototype was built with a horizontal impost and four window sashes (2 above, 2 below). As model served the still existing window with impost in the jutting. The use of the very thin triple glazing (2/8/2/8/2), with the thickness of a double glazing, made it possible that the frame proportion became even more fragile and the optic from inside becomes very similar to a double glazing.

#### Why does it work?

Conservation: The retrofit solution corresponds to the requirements of the heritage authority preserving subdivision and the proportions, as well as frame and sash bar thicknesses. With the historic produced single glazing in the outer sashes, the window avoids the typical optic of a double glazing. Moisture safety: The window construction after retrofit is generally moisture safe. The coupled window is identical to a new casement window in terms of moisture and driving rain impermeability. The outer layer of window sashes does have no function in terms of moisture safety as it is not tightly fitted to the inner layer. Energy improvement: Replacing the windows means at a large reduction of infiltration, improving the "airtightness" of the building. In the existing building infiltrations cause a large part of the heating energy demand. With the "air leakage test" it was verified, that (the not well maintained) windows cause a main part of the ventilation heat losses. Taking into account the window energy balance (losses minus gains) the net losses can be reduced by 70% (double glazing vs. original window) or respectively 80% (triple glazing). Looking at the total energy balance of the whole building with 14% of window area and walls in natural stones, the exchange of windows can reduce the demand by up to 20%: 10% due to thermal performance increase, 10% due to airtightness improvement (need for indoor air quality considered, without heat recovery). • U-values existing (box-type) window:  $U_g = \text{ca. } 2,8 \text{ W/(m}^2\text{K)}$ ;  $U_f = \text{ca. } 2,5 \text{ W/(m}^2\text{K)}$ ; Psi installation (without parapet) = 0,238 W/mK; Psi installation (with parapet) = 0,194 W/mK; g-Value = 0,77 • U-values new window after intervention:  $U_g = \text{ca. } 0,57 \text{ W/m}^2\text{K}$ ;  $U_f = \text{ca. } 0,97 \text{ W/(m}^2\text{K)}$ ; Psi installation (without parapet) = 0,164 W/(mK); Psi installation (with parapet) = 0,124 W/(mK); g-Value = 0,44 •  $U_w$ -value calculated for typical window size: 2,21 W/(m<sup>2</sup>K) (before retrofit); 0,89 W/m<sup>2</sup>K (after retrofit)

#### Description of the context

The Public Weigh House is a building of Romanesque origins in the historic city centre of Bolzano in Italy. At the end of the 16th century, there was a large reconstruction of the building, unifying e.g., the dimensions of window apertures and extending the building on the east side. The window size is therefore typical for baroque era. A major part of the original windows was however replaced by box type windows in the 1950s/60s, just a few original windows are from the late baroque era with thin wooden profiles and single glazing (e.g., in the jutting on the north façade). The unified window size dating from the 16th is typical for baroque era, also profiled sandstone frames date from this era. For shading and darkening, wooden window shutters are used. Since the box-type windows of the 1950s/60s are not of historic value, they could be replaced, reproducing the appearance of a historic window.

For the development of such a new window the aim was to (i) build a highly energy efficient window with Passive House quality and (ii) a window that answers to the heritage demands of the building.

## Pros and Cons

Pros: • Energy performance of a heritage compatible window can reach passive house standard and can be improved significantly (U<sub>w</sub>-value after: 0,89 W/m<sup>2</sup>K) • Preservation of the appearance of a historic window: subdivision and proportions, as well as filigree thicknesses of the wooden parts and historic produced single glazing in the outer sashes. Cons: • View from inside to the outside: Relatively high frame depth, optic of the three panes and single pane in series • Fundamental questioning from heritage point of view if composite windows are the right choice (when before the window solution of the 50/60s there was a single window).

## Type of data available

Photos, digital drawing, description, heritage value assessment (before retrofit), thermal simulation in Framesimulator, U<sub>w</sub>-value calculation, evaluation of conservator afterwards, passive house component certification, publications.

[https://www.hiberatlas.com/smarteredit/projects/89/18\\_international\\_Passive\\_House\\_Conference\\_Energy\\_efficiency\\_of\\_windows\\_in\\_hist\\_buildings\\_final.pdf](https://www.hiberatlas.com/smarteredit/projects/89/18_international_Passive_House_Conference_Energy_efficiency_of_windows_in_hist_buildings_final.pdf)

[https://www.hiberatlas.com/smarteredit/projects/89/D6.2\\_CS1\\_Public\\_Weigh\\_House\\_Bolzano\\_Italy.pdf](https://www.hiberatlas.com/smarteredit/projects/89/D6.2_CS1_Public_Weigh_House_Bolzano_Italy.pdf)

(Factsheet project PlanFenster)

## Best practice example

Timber-framed house in Alsace - France, <https://www.hiberatlas.com/en/timber-framed-house-in-alsace-france--2-45.html>

Thermal properties	Existing window	Refurbished window prototype
Window type	Box-type window 1950s/60s	Coupled window
Glazing	Inner window: single glazing Outer window: single glazing	Inner window: thin triple glazing Outer window: single glazing with historical optic (2-8-2-8-2-25-4 mm)
Shading	Existing window shutters	Existing window shutters
U <sub>w</sub>	2,21	0,89
U <sub>g</sub>	5,75/5,75	1,22
U <sub>f</sub>	2,40/2,14	1,22
g-value glass	0,71	0,44
Air tightness	No sealing	2-fold sealing
Approximate installation year	Building origins from end of 12th century, windows from 1950s/60s	Installation window prototype 2013

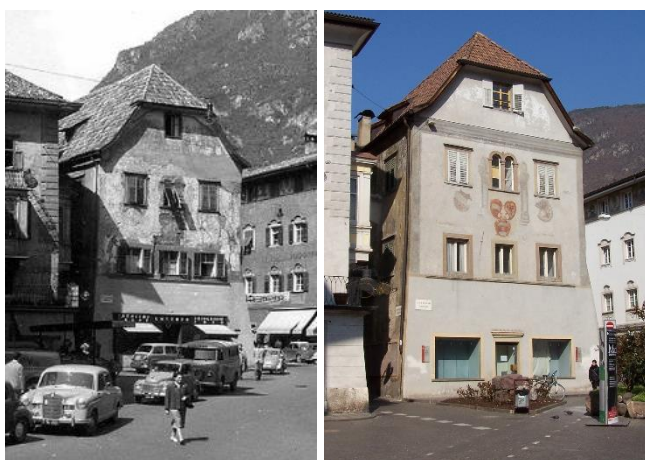

Figure 36: The Public Weigh House of Bolzano in 1958 and 2011 (before renovation)





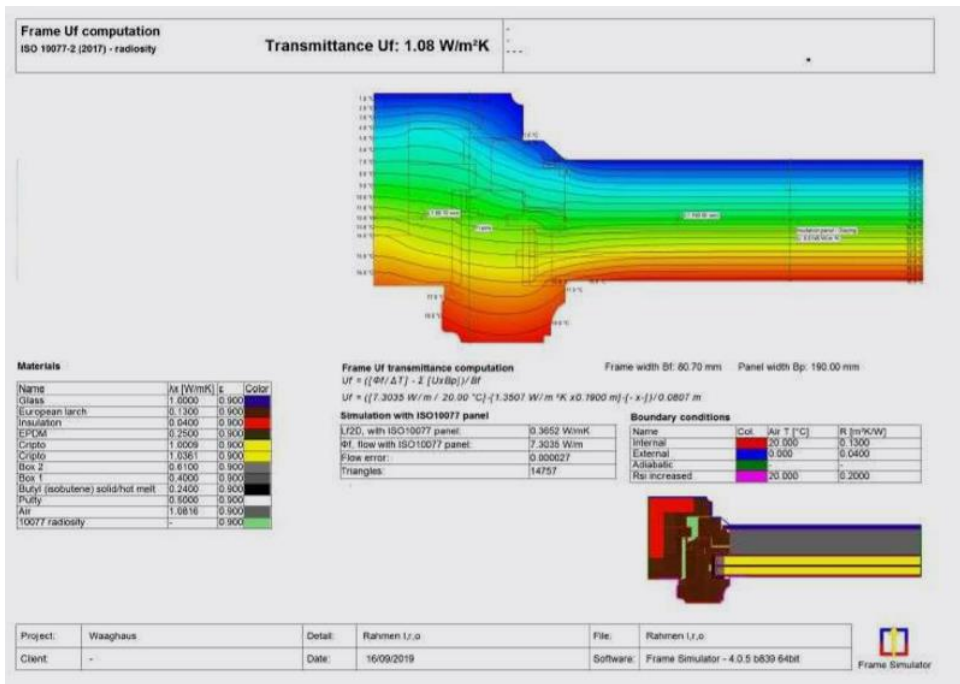

Figure 40: Calculation of Uf-value of the inner window sash after retrofit



Figure 41: Timber-framed house in Alsace (single window) – before and after renovation.

## 4 B Replacing the window (HI)

Author: Dagmar Exner (Eurac)

### What is the solution?

Existing windows are replaced by new, mostly industrially produced windows. However, this should only be the case if the existing window construction has no maintenance value whatsoever. The new windows can deviate considerably in their design from historical models but should nevertheless be characterized by a high design standard. The new windows are generally much more energy-efficient and typically have a U-value improved by 70-80%, which sometimes justifies replacement from the point of view of resource conservation.

### Why does it work?

This solution is only to be recommended if a repair or retrofit of the historical window construction is not possible (i) due to major damage, (ii) or it is only possible at disproportionately high expense, (iii) or if there are no requirements for its preservation from heritage point of view.

If one of these requirements are given, the solutions work, because the energy efficiency of the window construction can be improved significantly. If installed properly, it offers the possibility of improving the thermal bridge and the airtightness at the window-wall connection, preferably when installed with internal insulation.

### Description of the context:

The not listed building was constructed at the beginning of the 20th century near the old town of Bolzano as residential house. Since then, nothing has been changed in the appearance of the building. Aim of the retrofit was a cost-efficient energy retrofit, the reduction of heating costs and the maintenance of the historic appearance of the façade. The window refurbishment foresaw the removal of the old box-type windows and the installation of new triple-glazed windows with a special focus on the connection of the new window to the existing window frame (see detail drawing).

### Pros and Cons:

The pros of the solution are: Energy performance of the new window can reach passive house standard and can be improved significantly, improves indoor climate (higher surface temperature, less draught) and the possibility of improving the thermal bridge at the window-wall connection when installed correctly and preferably in connection with (internal) insulation.

The main disadvantage of the solution is that it significantly alters the inside and the outside of the building and the loss of the existing window construction.

### Type of data available:

Photos, digital drawing, description, thermal simulation,  $U_w$ -value calculation, evaluation of conservator afterwards

Factsheet project PlanFenster – Villa Moroder:

[http://www.eurac.edu/en/research/technologies/renewableenergy/projects/Documents/planfenster/08\\_RE\\_Planfenster\\_Villa%20Moroder\\_03.pdf](http://www.eurac.edu/en/research/technologies/renewableenergy/projects/Documents/planfenster/08_RE_Planfenster_Villa%20Moroder_03.pdf)

<b>Thermal properties</b>	<b>Existing window</b>	<b>Refurbished window prototype</b>
Window type	Box-type window	Single window
Glazing	Inner window: single glazing Outer window: single glazing	Triple glazing (4-12-4-12-4 mm)
Shading	Existing window shutters	Existing window shutters
$U_w$	-	1,13
$U_g$	-	0,7
$U_f$	-	-
g-value glass	-	0,49
Air tightness	-	2-fold sealing
Approximate installation year	1926	2015



Figure 42: House Moroder – before and after renovation.



Figure 43: House Moroder, window details – before and after renovation.



Figure 44: House Moroder, window details – during retrofit: integration of ventilation system, internal insulation at window reveal, connection of new window to existing frame

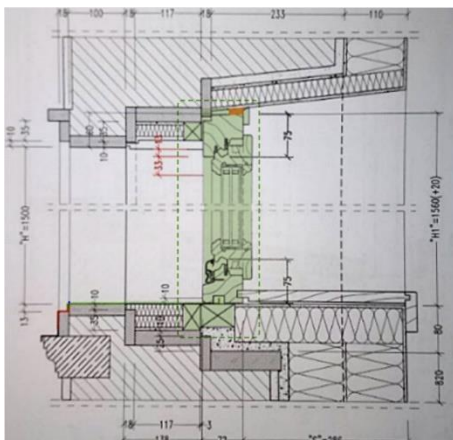

Figure 45: Window detail

## 2.7 Assessment of solutions according EN 16883:2017

### 2.7.1 Methodology of Assessment

The European standard EN 16883:2017 acts as a guideline for building owners, authorities and professionals to apply the existing standards in the field of energy efficiency to the specific requirements of historic buildings. It proposes and describes a systematic procedure for improving energy performance of historic buildings and, in particular, the assessment and selection of the appropriate measures that match the requirements of the building in question.

The standard provides a number of assessment criteria in the following categories:

- Technical compatibility
- Heritage significance of the building and its settings
- Economic viability
- Energy
- Indoor environmental quality
- Impact on the outdoor environment
- Aspect of use

In the course of IEA SHC Task 59, the criteria of the standard have been specified in detail in order to conduct a detailed assessment of the individual topics. The aim is to show how the assessment criteria should be applied and to convey the scope of such a detailed assessment. The following chapter contains the adapted and detailed assessment catalogue for the renovation of historical windows. Further on, the criteria catalogue is presented and exemplified in chapter 2.4.2.2 with the help of some practical examples.

### 2.7.2 Detailed Assessment of Windows

#### 2.7.2.1 Detailed Assessment criteria catalogue for Windows

##### Technical compatibility

###### *Hygrothermal risks*

The likelihood of condensation on the window surfaces (especially in the area of the glazing edge) and in the area of the thermal bridge of the window installation (window-wall (reveal and parapet), window-roof connection) will be evaluated, considering indoor and outdoor (?) moisture sources and surface temperatures. If excess moisture accumulation occurs at areas that can lead to other risks, see below.

Additionally, the airtightness of the window installation has to be evaluated. (MGI < 1,0)

###### *Structural risks*

Structural risks will be considered if solutions are applied that put more weight on the window structure e.g., the exchange of glazing on the historical window frames and fittings.

###### *Corrosion risks*

If one of the retrofit solutions is applied to metal windows, the corrosion risk will be considered. (Corrosion protection existing?)

###### *Biological risks*

Mould growth (health risk) on internal window surfaces or thermal bridges with regard the window installation or interstitial surfaces (i.e., surfaces of building materials composing the wall around the window) that may be in contact with the indoor environment will be evaluated.

### **(Thermal bridges - temperature factor frsi (EN ISO 10211))**

If insulation is intended for solid walls with timber elements (e.g., lintels) or connected to timber elements (e.g., floor joists), the influence of insulation on wood rot (structural risk) will be considered.

### **(Wood damage according VTT-model)**

#### *Robustness/Buildability/design/Application*

Is the solution robust and buildable? Are there special requirements in design or application?

The design of the solution must be tailored to the specific needs of each building. Hence, the requirements of the on-site application as well as the robustness and buildability of the solution will be assessed in detail case-by-case.

#### *Thermal bridges/Connection*

Is there a risk of thermal bridges when installing this solution?

At the connection between windows and walls, thermal bridges and air infiltrations are concentrated: If I increase the technical performance of one of the two elements, the risk of decay (for example mould growth), linked to these weaknesses, grow, with a negative impact on the whole building. Building components are connected to each other and, therefore, in the assessment of the window solutions it is necessary to adopt a global vision of the building. Every single action, even if minimal, may have either a negative or a positive impact. Hence, the window-wall connection will be thoroughly assessed, especially when replacing existing windows with more performing systems or when adding a new window layer. Need for maintenance of connection over time will also be evaluated.

#### *Reversibility*

Is the solution completely reversible or can the intervention be considered as highly sustainable and compatible? The term "reversibility" indicates the possibility of returning the initial situation without modifying the aesthetic, chemical and physical characteristics of the historic building. This implies a preference for low impact measures that do not damage the heritage. In the case of window interventions, for example, the addition of foil to the glass is a reversible solution because it can be easily removed at any time, while replacing the window sashes, the glass layer or the whole window is not reversible because it leads to the loss of the historical material consistency. A careful assessment of the ease of reversibility of the solution, linked to the single historic building specificities, is necessary.

## **Heritage significance of the building and its settings**

### *Material, constructional, structural impact*

Any refurbishment should aim at achieving the optimal protection of the existing building structure. In the field of preservation of historic monuments, however, there is a need for preservation beyond the purely structural demands, including the preservation of certain building attributes and the values they convey. Historical windows were made of the available material - in the Historic Buildings these are mostly wooden casements, since industrialisation increasingly steel constructions. The glass also has characteristics related to the respective production; from the first plate glass from the 12th century, rolled glass from the 17th century to drawn glass and the more recent industrial glass. The replacement of frame parts, glass, window sashes or entire windows thus not only means the loss of historical substance. At the window, the structure also preserves the historical craft traditions, which are then lost.

The following 'invasivity' levels can be defined in terms of material, construction, and structure:

1. Low impact: repairing of smaller defects in the wood and of damaged glass, the renewal of the protective coating and cracked putty joints, as well as adjusting the hinges.
2. Medium-Low impact: the inserting of a sealing and the addition of foils to the glass
3. Medium impact: adding an extra layer of glass to the inside or outside, adding a new layer/new sash to the window (e.g., extension of a single glass window to a box-type window)
4. Medium-High impact: Replacement of parts of the window, so that the existing structure is still recognisable, e.g., the replacement of a window sash, glass etc.
5. High impact: substitution of the existing window with a replica or a new design

### **(Do the used materials attack the existing structure / surface in any way?)**

### *Architectural, aesthetic, visual impact*

A visual impact caused by interventions on the windows very much depends on the manner of execution. The adding of a foil has a low impact but, when changing the colour, also a high impact. The same can be said for the replacement: if this is a 100% replica done with historic craftsmen technics it is a low impact, while a replacement with a new design will be a high impact.

Therefore, a separate consideration for the single elements of the window is necessary: frame, sash, glass. For multi-layered windows one must also distinguish between the interior and exterior view

1. Low: maintenance of existing elements and repairing, replacement of parts with historic craft technics, while keeping the original frame geometry (e.g., exchange of glass with historic glass)
2. Low-medium: Exchange of parts of the window with adjustments of the existing structure (e.g., extension of the frame to fit a new glass in), window bars and frame division are preserved.
3. Medium: replacement of parts or adding of new layers while keeping the historic frame division and the functionality (opening direction and number of sashes)
4. Medium-High: replacement of the existing window with an industrially manufactured product with reference to the original window in design, frame, divisions etc.
5. High: Replacement of the existing window with a new design

### *Spatial impact*

Spatial influence can occur during window renovation under the following circumstances: 1) The window is changed in its position in the wall 2) The geometry of the opening sash is changed, e.g., a double-wing window is replaced by a single-wing window - the new sash extends further into the room when opened.

## **Economic viability**

### *Capital costs*

The direct cost of installing the solution and the economic savings will be evaluated (prior to installation). If the installation is done in combination with other measures, not referring to energy renovation, then only the additional costs caused by renovating the windows is to be included, to evaluate whether the installation is economic viable, based on estimates of installation cost and energy savings, and expected service life (example: if scaffolding is needed for repairing the roof to avoid moisture damage and it can also be used when installing windows, the cost of the scaffolding is not to be included).

The capital cost could also be expressed using a monthly credit payment considering the cost of the credit at the moment as most of the building's owners will need such arrangement. This will also permit to compare the monthly economic saving with the credit payment.

### *Operating costs, including maintenance costs*

Economic viability can also be evaluated including the operation/maintenance costs (life cycle economy). This may influence which specific solution to choose, in the case more than one solution is considered.

### *Economic savings*

To assess the economic savings, one must perform thermal simulations of the buildings before and after the retrofitting. If replacing or refurbishing windows is the only energy improvement in the building, a simpler alternative is possible by calculating the energy balance for the windows before and after retrofit, i.e., the balance between heat loss through the windows (U-value) and heat gains through the window (g-value). This can be used as a faster evaluation of the expected energy savings. The reduction in energy consumption can be converted to a monetary value by e.g., considering a scenario of increase in the energy purchase price year after year. It is also possible to take into consideration the increase of the value of the retrofitted building if need be.

### *Economical return*

The calculation of the economical return should be based on the overall levelized cost. It begins with the capital cost as defined in the capital cost section plus the cost of the credit if needed. Then the discounted cost of the expected operating and maintenance cost on a fixed period (usually 30 years) are added. The economy on the energy bill has to be calculated considering a scenario of an increase in the purchase price. This scenario has to be stated. The economical return has to be compared with the expected service life.

Two kinds of calculations could be performed: with or without public subsidies.

Reference (norm ISO 15686-5)

## Energy

*Energy performance and operational energy demand in terms of primary energy rating (total), primary energy rating (non-renewable), primary energy rating (renewable)*

Regarding the solutions for the windows, the improvement of the U value will be evaluated along with the influence on the total solar energy transmittance of the glazing. How the solution resolves the thermal bridges (such as window wall connection) will also play a role in the evaluation.

*Life cycle energy demand in terms of use of renewable primary energy and non-renewable primary energy*

The LCA analysis' result (if available) is evaluated. In the LCA calculation all the stages of the life of the product are considered: from the raw material extraction, through the material manufacture, to the disposal or recycling of the product.

## Indoor environmental quality

*Maintaining the desired level of indoor environmental quality and user comfort is the prime objective of most buildings. The indoor environment shall be suited for the intended future use of the building. A poor indoor environment may be a reason to improve the energy performance of a building.*

*Indoor environmental conditions suitable for building content preservation*

Indoor environmental targets should be determined by general standards for the conservation of the building content, including movable cultural heritage objects. The indoor environmental requirements to achieve building conservation have been specified in EN 15757.

*Indoor environmental conditions suitable for building fabric preservation*

Indoor environmental targets should be determined by general standards for the conservation of the building fabric, including fixtures and decorative surfaces of the interiors. The indoor environmental requirements to achieve building conservation have been specified in EN 15757.

*Indoor environmental conditions suitable for achieving good occupant comfort levels*

Indoor environmental targets should be determined by general standards for occupants' comfort. The indoor environmental requirements to achieve user comfort have been specified in EN 15251, EN ISO 7730, and ASHRAE 62-2001.

*Emission of other harmful substances*

In addition to the evaluation of the renovation solution on the durability of the building and its content, and the comfort of its occupants, it is necessary to prevent any harmful emission that might have a negative effect on users' health. Additional information on protection of public health from risks due to a number of chemicals commonly present in indoor air can be found in the WHO Guidelines for Indoor Air Quality: Selected Pollutants.

## Impact on the outdoor environment

Life cycle energy demand in terms of greenhouse gas emissions and emissions of harmful substances

The LCA analysis' result (if available) is evaluated. In the LCA calculation all the stages of the life of the product are considered: from the raw material extraction, through the material manufacture, to the disposal or recycling. The LCA should focus on the ecological impact of the material's life, with the focus on greenhouse emissions and emission of harmful substances.

## Aspects of use

### *Influence on the use and the users of the building*

What is the influence of the solution on the use and the users of the building?

Users' behaviours are influenced by both environmental parameters (indoor and outdoor temperature, relative humidity etc.) and daily routine. The user-window interaction, in particular, impacts significantly on the use of energy and thermal comfort. Hence, this aspect will be investigated in depth with reference to the specific solutions.

## 2.7.3 Detailed assessment examples of window solutions

### 2.7.3.1 Window solution – adding a layer on the inside of the window



Figure 46: “Giatlahaus “Innervillgraten, copyright: Lukas Schaller (left), Pavel Sevela (right)

## Technical compatibility

### *Hygrothermal risks*

By using a new modern window, condensation on the inner surface of the frame and glass can be eliminated. The window can be airtightly connected to the vapour barrier of the wall structure and should prevent the escape of moist warm air. Another important point is the space between the old window and the new one. In order to remove any moist warm air as quickly as possible, air holes were integrated into the reveal of the old window. This ensures that no condensation can occur on the inside of the old window.

### *Structural risks*

There are no structural risks.

### *Corrosion risks*

There are no corrosion risks.

### *Biological risks*

Due to the high U-values of the wooden frame ( $U_f = 1.55 \text{ W/m}^2\text{K}$ ) and the triple insulating glazing ( $U_g = 0.6 \text{ W/m}^2\text{K}$ ), no mould growth can be expected. The windows were installed internally flush with the new block wall. From an energy point of view, it would make sense to move the window to the insulation level. Due to the wooden block wall and the associated lower thermal conductivity in comparison to a bricked facing shell, there is no critical surface moisture at the transition from window to wall which would allow mould growth.



### *Robustness/Buildability/design/Application*

The solution can hardly be distinguished from window installation in a new building. Only the ventilation between old and new windows is an additional task.

### *Thermal bridges/Connection*

By creating a completely new interior wall with the integration of energy efficient windows, no negative effect on other components of the house can be achieved. The windows correspond to the state of the art. Potential for improvement regarding thermal bridges could be achieved, as already mentioned above, by a non-flush installation in the newly erected timber construction. The energy losses would be minimized by moving the window into the insulation level.

### *Reversibility*

This solution is theoretically almost completely reversible. The entire wall construction can be dismantled including the windows. Only the air holes between the old window and the new window are irreversible.

## **Heritage significance of the building and its settings**

### *Material, constructional, structural impact*

In terms of material, constructional and structural impact the solution can be classified as "low impact". By adding a new layer to the window, the interior appearance is completely changed in terms of material and structure. But if you open the new window, the original window with the installation situation and all original materials are preserved and conserved. This is a fundamental intervention, but the old window is basically untouched.

### *Architectural, aesthetic, visual impact*

The architectural, aesthetic, and visual impact of this solution can be evaluated as "medium impact". The original window is still visible from the inside and outside, but in combination with a new wooden block wall and new windows, a modern wall is basically placed in front of the old one. From the outside, the aesthetics and architecture are thus preserved. From the inside, the new window openings look more like paintings on the wall that represent the original appearance of the building and its windows.

### *Spatial impact*

The external appearance of the building is not modified. The original proportions of the building are not changed and remain unchanged. From the inside, a complete redesign and reinterpretation of the architectural concept is carried out.

## **Economic viability**

### *Capital costs*

The capital costs of this solution are simple to calculate. By the installation of a new window no heritage-specific companies or measures are necessary. Basically, the same costs as for a new building can be assumed. Depending on the type of wood and manufacturer, the costs can vary. Also, the installation situation hardly represents an additional expenditure compared to an installation in a new solid wood building.

### *Operating costs, including maintenance costs*

By installing new windows, a long durability can be expected. However, maintenance for adjusting the sashes and maintaining the seal must be included in the calculation, as with any window. Due to the weather protection provided by the original historical windows, the new window is more durable. However, the historical windows are still exposed to the weather and therefore need to be checked and maintained. Possible damage to the frame or glass must be repaired immediately to prevent rainwater from entering the insulation level.

### *Economic savings*

Due to the new window the transmission losses of the window are significantly reduced. The existing window has a UW - value of about 2.4 W/m<sup>2</sup>K. In a renovated form, the thermal resistance of the existing window can no longer be taken into account as the window is ventilated as described above. The new modern window has an average UW value of 0.9 W/m<sup>2</sup>K (based on a size of approx. 1.0 x 1.0 m). Thus, an energy saving of approx. 1.5 W/m<sup>2</sup>K per square meter can be achieved. With 6029 Kd heating degree days, this results in a saving of approx. 58 kWh/a per m<sup>2</sup> window area. A further increase in energy efficiency is achieved by the considerably increased air tightness of the window openings. In contrast, the additional triple glazing reduces solar gains.

### *Economical return*

If the annual savings per square meter are compared to the investment costs, the payback period for the windows is relatively long. With net costs of about 400 €/m<sup>2</sup>, the payback period is over 40 years. For economic reasons, a window exchange is in many cases subordinate interesting, however, also the considerable increase of the living comfort as well as the building physical necessity of a refurbishment must be included in the assessment.

## **Energy**

*Energy performance and operational energy demand in terms of primary energy rating (total), primary energy rating (non-renewable), primary energy rating (renewable)*

As already mentioned above, there is a significant improvement in terms of energy efficiency. Transmission losses are significantly reduced, the installation situation and air tightness are improved many times over.

*Life cycle energy demand in terms of use of renewable primary energy and non-renewable primary energy*

No LCA analysis was performed.

## **Indoor environmental quality**

Maintaining the desired level of indoor environmental quality and user comfort is the prime objective of most buildings. The indoor environment shall be suited for the intended future use of the building. A poor indoor environment may be a reason to improve the energy performance of a building.

*Indoor environmental conditions suitable for building content preservation*

There are no special contents (fonts etc.) that need to be protected in the building. The air tightness of the building is increased by installing the windows. However, due to the installation of a ventilation system, no problems associated with excessive humidity are to be expected.

*Indoor environmental conditions suitable for building fabric preservation*

As already mentioned in the previous point, too high relative humidity's are avoided by ventilation. This is particularly important in connection with interior insulation, as low RH values in the interior improve the function of interior insulation systems.

*Indoor environmental conditions suitable for achieving good occupant comfort levels*

The increased surface temperature reduces radiation differences between interior and exterior walls (including windows). This increases the comfort of living. Drafts due to insufficiently tightly installed windows are also eliminated.

*Emission of other harmful substances*

No harmful substances are included in the solution.

## Impact on the outdoor environment

*Life cycle energy demand in terms of greenhouse gas emissions and emissions of harmful substances*

No LCA calculations were performed.

## Aspects of use

*Influence on the use and the users of the building*

In general, it should be noted that by installing airtight windows, the ventilation behavior of the residents must be changed. If previously there was a sufficient air exchange due to the air leaks, after the installation of modern windows or airtight assembly, the building must be ventilated several times a day. Due to the installed ventilation system, this is not necessary in this case.

### 2.7.3.2 Window solution: Installing glass from floor to ceiling on the inside

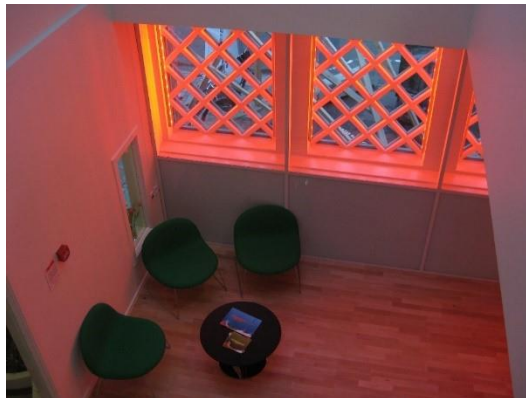

Figure 47: Floor-to-ceiling layer of glass on the inside of the façade (Photo: Wissenberg)

## Technical compatibility

### *Hygrothermal risks*

Since the internal sheets of glass has joints with the ceiling and floor, it is very important that these joints are airtight to avoid that warm indoor air comes in contact with cold surfaces. The glass itself is, of course, airtight, but the joints are vulnerable and there is a need for careful craftsmanship. The internal sheets of glass also have horizontal and vertical joints which need to be airtight to avoid warm air entering the space between the new glass and the old windows. Otherwise, condensation may occur on the surface of the old windows.

### *Structural risks*

The solution does not include any structural changes and therefore there are no risks.

### *Corrosion risks*

No metal is included in the solution and therefore there are no corrosion risks.

### *Salt reaction risks*

No salt reaction risks.

### *Biological risks*

As already mentioned under “Hygrothermal risks”, keeping all the joints airtight is very important. If there are leaks in any joints there is a very high risk of condensation and in the longer run also mould growth, both in the cavity between glasses but also inside the construction (between the new insulation and the old construction).

### *Robustness/Buildability/design/Application*

This solution, as already mentioned, relies on air tightness of all joints, and therefore requires careful craftsmanship during the implementation phase.

### *Thermal bridges/Connection*

The new joints have no thermal bridges and therefore air tightness is the main concern.

### *Reversibility*

The solution is completely reversible since it does not alter any of the original materials or constructions.

## **Heritage significance of the building and its settings**

### *Material, constructional, structural impact*

The solution does not impact the material, constructional or structural impact of the building.

### *Architectural, aesthetic, visual impact*

Adding an internal layer of glass from floor to ceiling has no impact on the architectural, aesthetic, or visual impact from the outside, but a significant impact on these aspects from the inside. The photographs below demonstrate how the solution has visually impacted the view from the inside. The left photo shows the effect on the façade from the inside and the right shows how the installed LED-lighting also plays a significant role.

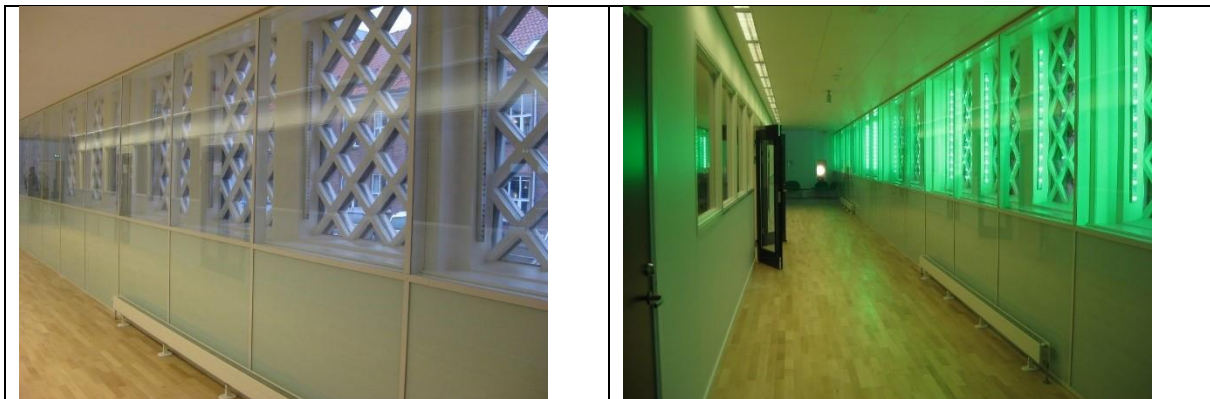

*Figure 48: Floor-to-ceiling layer of glass on the inside of the façade (Photos: Wissenberg)*

From the outside the changes are not visible, except, of course, when the LED-light is turned on. The solution would therefore be rated as a medium impact solution.

### *Spatial impact*

The solution has a spatial impact since the layer of glass is added on top of 25 + 50 mm of insulation against the wall. The drawing below shows in red the added insulation and in yellow the added glazing.

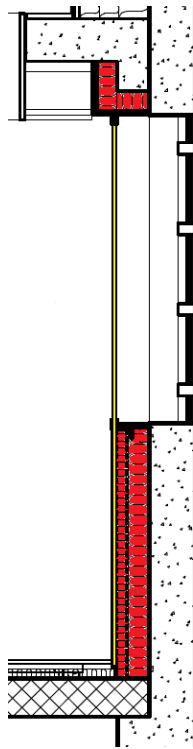

Figure 49: Vertical cross-section of the façade. The insulation marked in red was added to further reduce thermal bridge effects (Drawing: Wissenberg)

The solution thereby reduces the indoor space by approx. 80 mm along the façade.

## Economic viability

### Capital costs

The total investment for the solution is approx. €48,000 and the total area of the glazing is approx. 68 m<sup>2</sup>. This means that the investment per m<sup>2</sup> is €750.

The overall total investment of the renovation carried out for the Osram Building is approx. €564,000, which means that the special solution for the ground floor windows in the façade accounts for approx. 8.5% of the total investment.

### Operating costs, including maintenance costs

Operating and maintenance costs for this part of the renovation are expected to be zero.

### Economic savings

The economic savings expected from the measure is partly due to the improvement of the wall U-value reduced (from 3.7 to 0.4 W/m<sup>2</sup>K) and partly due to the improvement of the window U-value reduced (from 5.8 to 1.2 W/m<sup>2</sup>K). Since the windows are covered on the outside by crossing beams, the solution is expected to have only little or no influence on daylighting and solar gains. The overall expected savings are €1,200 per year.

### Economical return

Based on the capital costs (€48,000) and the expected economic savings (€1,200 per year), the simple payback time for the solution can be calculated as 40 years. This is by far the highest payback time for all the measures carried out at the Osram Building, however the significant improvement of the indoor climate is difficult to monetize, and from a comfort point of view the investment is well worth it.

## Energy

### *Energy performance and operational energy demand in terms of primary energy rating (total), primary energy rating (non-renewable), primary energy rating (renewable)*

As already mentioned, the improvement of the wall reduces the U-value from 3.7 to 0.4 W/m<sup>2</sup>K and the window U-value from 5.8 to 1.2 W/m<sup>2</sup>K. The reduction in the energy consumption corresponds to approx. 13,300 kWh per year and a reduction in CO<sub>2</sub>-emissions of approx. 2,580 kg per year. The building is supplied by district heating which, in Copenhagen, is based on 68% renewable resources.

### *Life cycle energy demand in terms of use of renewable primary energy and non-renewable primary energy*

No LCA analysis was performed.

## **Indoor environmental quality**

Maintaining the desired level of indoor environmental quality and user comfort is the prime objective of most buildings. The indoor environment shall be suited for the intended future use of the building. A poor indoor environment may be a reason to improve the energy performance of a building.

### *Indoor environmental conditions suitable for building content preservation*

This solution has no negative effects on the building content, on the contrary the solution improves the indoor climate significantly and thereby helps to maintain a good indoor climate.

### *Indoor environmental conditions suitable for building fabric preservation*

In this solution there are no fabrics or decorative surfaces to be preserved.

### *Indoor environmental conditions suitable for achieving good occupant comfort levels*

This solution improves the local indoor environmental conditions near the façade by removing drafts and cold surfaces. This means that it is now possible to utilize the area near the façade without the risk of discomfort. The image below shows how the renovated façade has made it possible to have seating arrangements near the renovated façade.

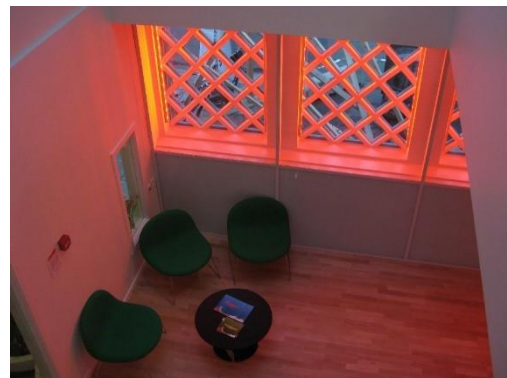
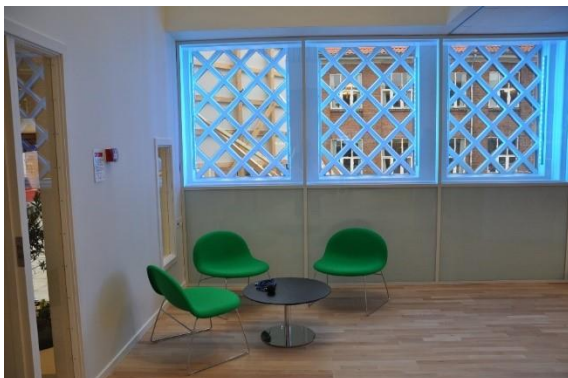

Figure 50: LED-lighting was added to open the possibility for setting different moods in the culture centre (Photos: Wissenberg)

## **Emission of other harmful substances**

No harmful substances are included in the solution.

## **Impact on the outdoor environment**

### *Life cycle energy demand in terms of greenhouse gas emissions and emissions of harmful substances*

No LCA calculations were performed.

## **Aspects of use**

### *Influence on the use and the users of the building*

The Osram Building is used as a culture centre both before and after the renovation, so there is no change in the use. The renovation, however, has improved the indoor climate significantly (daylighting levels, temperature levels, indoor air quality etc.) and thereby improved the comfort levels for users. The particular solution described here has, as mentioned above, also made it possible to utilize the areas near the façade without the risk of discomfort.

## 2.7.4 References

[1] Ruders og Vinduers Energimæssige Egenskaber – Kompendium 1: Grundlæggende Energimæssige Egenskaber, BYG.DTU U-001, 2009, Version 8, ISSN 1396-4046 (in Danish).

[2] Historic Environmental Scotland, *Technical Paper 1: Thermal Performance of Traditional Windows*, 2006.

[3] Historic Environmental Scotland, *Fabric Improvements for energy efficiency in traditional buildings*, 2013, pp. 13-19.

[4] Historic England, *Traditional Windows: Their Care, Repair and Upgrading*, 2017, p. 50.

[5] Suhr M. and Hunt R., *Old House Eco Handbook*, UK: Frances Lincoln, 2013, pp. 80-81.