

# THE DESIGN LANGUAGE

DESIGN INFORMATION BOOKLET NUMBER SEVEN

JUNE 1988

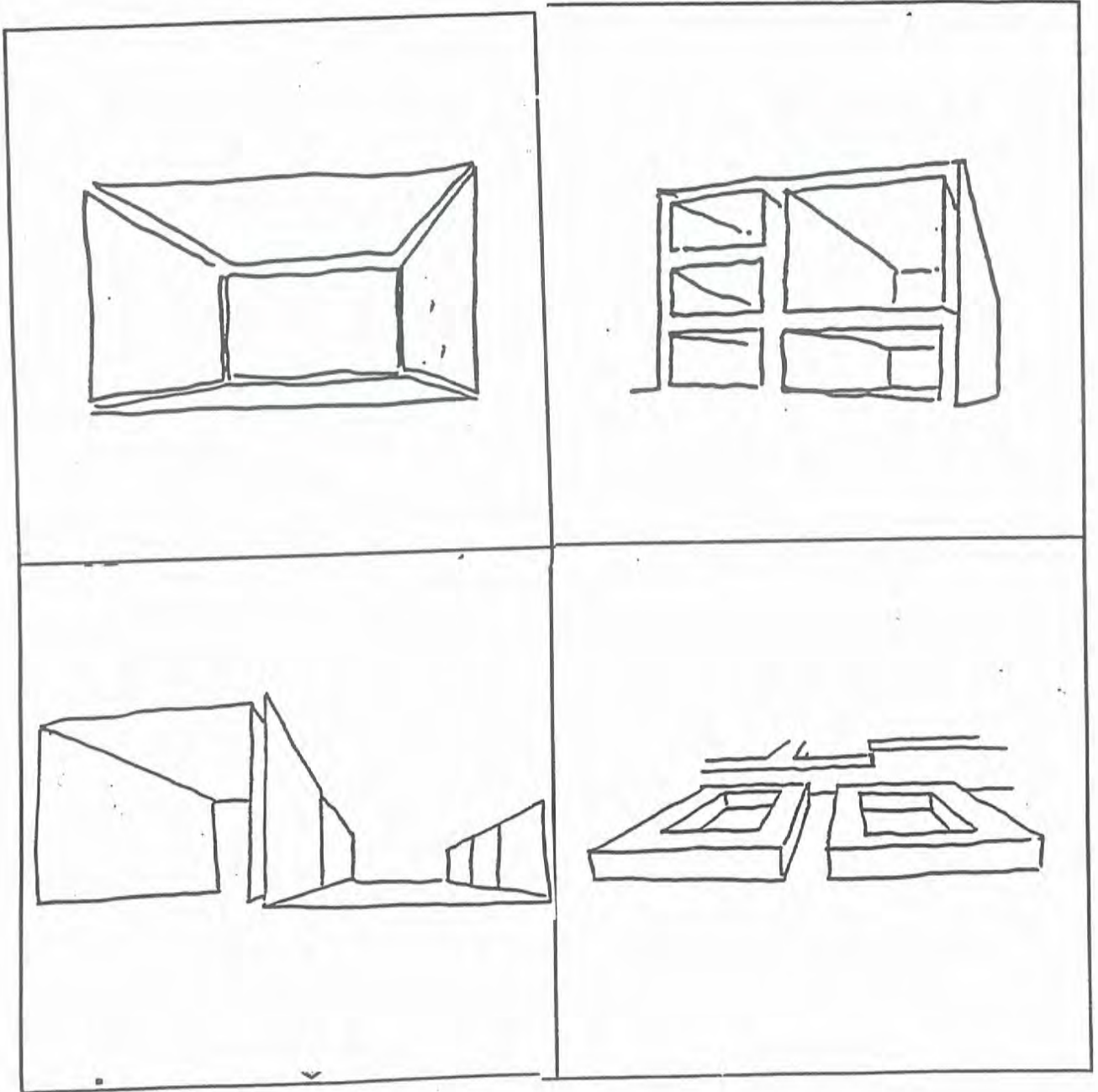

PASSIVE AND HYBRID SOLAR ENERGY BUILDINGS

# THE DESIGN LANGUAGE

7

DESIGN INFORMATION BOOKLET NUMBER SEVEN

JUNE 1988

Sergio Los  
Dipartimento di Progettazione Architettonica  
Istituto Universitario di Architettura di Venezia

Unita' Operativa: Prof. Arch. Sergio Los, Arch. Roberto Grossa, Arch.  
Natasha Pulitzer

# FOREWORD

---

This booklet is part of a series of booklets produced under an International Energy Agency project on Passive and Hybrid Solar Low Energy Buildings. The goal of this project is to accelerate the technical understanding and marketplace availability of energy efficient, passive solar homes. Fourteen countries have participated in the research - Austria, Belgium, Canada, Denmark, Federal Republic of Germany, Italy, Netherlands, New Zealand, Norway, Spain, Switzerland, Sweden, United Kingdom and United States.

The Design Information Booklets in the series are listed and described on the opposite page. These booklets can be purchased from the following organizations:

<b>Austria</b> Osterreichisches Forschungszentrum Seibersdorf A - 2444 Seibersdorf	<b>Germany</b> Projektleitung Biologie, Okologie und Energie Postfach 1913 D - 5170 Julich	<b>Norway</b> A/S Miljøplan Kjørbuavn 23 N - 1300 Sandvika	<b>United Kingdom</b> Energy Technology Support Unit Building 156 Harwell Laboratory Oxfordshire OX 11 0RA
<b>Belgium</b> Science Policy Office Rue de la Science 8 B - 1040 Brussels	<b>Italy</b> Consiglio Nazionale Ricerche Progetto Finalizzato Energetica Via Nizza 128 I - 00198 Roma	<b>Spain</b> IER - CIEMAT Avda Complutense 22 28040 Madrid	<b>United States</b> N.T.I.S. 5285 PortRoyal Road Springfield, Virginia 22161
<b>Canada</b> Solar Energy Development Energy, Mines and Resources 460 O'Connor Street Ottawa, Ontario K1A 0E4	<b>Netherlands</b> Management Office for Energy Research (PEO) P.O. Box 8242 NL - 3503 - RE Utrecht	<b>Sweden</b> Swedish Council for Building Research St Goransgatan 66 S - 11233 Stockholm	
<b>Denmark</b> Thermal Insulation Laboratory Technical University of Denmark Building 118 DK - 2800 Lyngby	<b>New Zealand</b> School of Architecture Victoria University of Wellington Private Bag Wellington 1	<b>Switzerland</b> Federal Office of Energy CH - 3003 Berne	

The International Energy Agency (IEA), headquartered in Paris, France, was formed in November 1974 to establish cooperation among a number of industrialized countries in the vital area of energy policy. It is an autonomous body within the framework of the Organization for Economic Cooperation and Development. Twenty-one countries are presently members, with the Commission of the European Communities participating under a special arrangement.

One element of the IEA's program involves cooperation in the research and development of alternative energy resources in order to reduce excessive dependence on oil. A number of new and improved energy technologies that have the potential of making significant contributions to global energy needs were identified for collaborative efforts. Solar heating and cooling was one of the technologies selected for joint activities. Cooperative research is conducted under terms of a formal Implementing Agreement signed by the participating countries. The overall program is managed by an Executive Committee, while the management of the individual projects or tasks is the responsibility of operating agents.

## **Booklet No. 1 Energy Design Principles in Buildings**

This Booklet is essentially a primer of heat transfer in buildings. Fundamental heat transfer concepts and terminology are defined, followed by a discussion of heating and cooling strategies and principles for passive and hybrid solar buildings. It is written in non-technical language for the designer or builder not familiar with general heat transfer principles.

## **Booklet No. 2 Design Context**

Booklet number 2 defines, in a checklist format, the issues that are unique to energy conserving, passive solar design that must be considered early in the design process. Issues discussed include site and climate analysis, building organization and design, building system options, space conditioning options, user influence and building codes and zoning ordinances.

## **Booklet No. 3 Design Guidelines: An International Summary**

Passive solar and energy conservation design guidelines have been developed by each participating country. These guidelines are presented in national design guidelines booklets. Booklet number 3, Design Guidelines: An International Summary, summarizes the major findings and patterns of performance observed from the national passive solar and energy conservation guidelines.

## **Booklet No. 4 Design Tool Selection And Use**

This Booklet addresses the characteristics desirable in a design tool and a means to select one or more for use. The selection process is organized around the design process; what design questions are being addressed, what information is available, what output or result from a design tool for which one is looking. A checklist is provided to assist in design tool selection. The use of benchmark test cases developed from detailed building energy analysis simulations is presented as a means to evaluate simplified design tools.

## **Booklet No. 5 Construction Issues**

Construction problems unique to the use of passive and hybrid solar features are defined in this booklet as well as several proven solutions. Due to the unique construction technology in each country, representative construction details are provided. The intent is to define where construction detailing is crucial to the performance of low energy, passive solar homes and provide some ideas on how these detailing problems can be solved for a range of construction technology.

## **Booklet No. 6 Passive Solar Homes: Case Studies**

This Booklet describes the passive and hybrid solar houses designed, constructed and monitored under the IEA Task VIII project, as a means of showing the architectural impact of energy conservation and passive/ hybrid solar features. This booklet reinforces the idea that good energy design is also good architecture and is cost effective. Each of the passive solar houses is presented as a case study on the design, construction and performance results.

## **Booklet No. 7 Design Language**

Booklet number 7 is aimed at designers, architects and educators. It defines an approach to generating whole building solutions based on climate analysis and design context analysis. It also addresses architectural typologies based on climatic/ energy principles. This booklet forms a general, universal companion to Booklet No.3, Design Guidelines.

## **Booklet No. 8 Post Construction Activities**

Post Construction Activities defines issues to be considered once the project is constructed and occupied. It addresses those elements of the passive solar building that are unique and may require special attention by the occupants. Performance evaluation of the home in terms of energy performance, comfort and occupant satisfaction is also addressed as a means of providing information back to the designer on how well the project is performing.

**PART 1**

**THE REGIONALISTIC DESIGN LANGUAGE METHOD**

- 1.1 2 ● Theoretic remarks
- 1.2 2 ● In <sup>praise</sup>prairie of imitation
- 1.3 2 ● The design process fallacies
- 1.4 2 ● The controls of design
- 1.5 3 ● Using the grammar to design a multiscale architecture

**A TYPOLOGIC GRAMMAR**

- The de-construction of settlement systems
- The room structure
- Site Group (SIG) modules, the plan layout
- Shelter Group (SHG) modules, the walls enclosure
- Shelter Group (SHG) modules, the roof/ceiling
- The composition of the room

**THE ARCHITECTURE LANGUAGE WITHIN THE DESIGN PROCESS**

**PART 2**

**THE TYPOLOGIC GRAMMAR FOR NORTH ITALY**  
**THE COMPOSITION RULES** selecting, planning and transforming architectural types  
**THE REPERTOIRES**, their organization and management

## INTRODUCTION

---

### THE PROBLEM

The problem addressed in this booklet emerges from the difficulties of transferring the results of research to improve the energy efficiency of buildings to design professionals for application. The basis of these difficulties is the current design tool philosophy that emphasizes the evaluative aspects of the design process rather than the generative aspects.

A method is proposed, based on the concept of a design language, that integrates these aspects to overcome the shortcomings of the unilateral evaluative design process.

One goal of a design language is saving energy. This energy savings must be obtained through some specific improvements of residential buildings. Therefore, it must be realized that such improvements will modify the current design process carried out by professionals, which determines the shape of these buildings, hence their energy performance. The improvements of environmental qualities (comfort, climate, daylighting, etc.) with a lower consumption of traditional non-renewable energy sources, become effective in these residential buildings by the use of design tools developed within the research activities carried out in different places and transferred to design practitioners. Even the best design tools, before their transfer, are useless; building energy performance does not change.

The transfer of design tools to the design profession has rarely been considered by design tool research organizations. Surveys conducted by the authors impute the major disturbances affecting design tools transfer to the current concepts of design process, operant within the design culture as influenced by the modern movement effort of engineering architecture.

The booklet is divided into two parts: Part 1 develops the design language, including all assumptions; Part 2 shows an application to a particular regionalist language of design carried out for the northern Italian regions.

The design language method can be used to compile other regionalist languages of design for various climatic and cultural areas, as a means to improve the transfer of energy saving design techniques developed through research.

Architects make decisions regarding the design and construction of buildings. A decision is an intentional act of passing judgment on an issue under consideration, presumably with a full understanding of the consequences of the decision. Architects are supposed to know the consequences of design and construction decisions upon the ultimate performance of the building. Their professional competence consists in coupling the construction acts, foreseen through the design drawings, with their performance consequences. Building clients are concerned with the ultimate building performance (consequences), which they are supposed to know very well, and they want the architect to be able to couple this building performance (consequences) with the correct construction acts. Building clients generally know their own performance requirements because of their experience with existing buildings that have satisfactorily or unsatisfactorily met their or similar performance requirements. These buildings represent answers to implicit questions. The shapes of buildings make people aware of the inhabiting (performance) requirements they are pursuing and of the desired consequences represented in the building.

The consequences (requirements) that the building clients define are the performances which allow them to operate as they should like in the building that the architect is designing for them. And the architect can improve their decisions about the building acts as he, better than any other, knows how to couple correctly the shapes resulting from these building acts with the related performances/consequences.

The consequences we are involved in deal with saving energy. What kind of construction acts could produce the shapes whose consequences should be a reduction of the energy consumed for the building climatization? Only architecture can make the people aware of the energy saving needs by showing the shapes which stand for such desired consequences.



### 1.2 IN PRAISE OF IMITATION

When we see an architect designing at his drawing board, we have to think that he is foreseeing through the drawings the future consequences of the building acts. The shapes he is tracing on the paper are for him coupled with the performances they will provide for the client. This connection between the shapes and the related performances is crucial for his competence; lacking the skill to couple shapes and performances, or according to Prieto tools and operations, the architect shall be of no help in improving the decision-making of his clients. ( )

A code provides the designers with this capacity of foreseeing the outputs of a future building, coupling the construction acts with the related consequences.

Drawings have been invented as a means to help designers in foreseeing, through the operant code, the performances of their shapes. The building science, developed within the Polytechnics and strongly enhanced by the modern movement functionalism, has shifted this knowledge after the definition of the shapes by assigning it to a specialist designer, the engineer.

The coupling that the designers are doing in designing is a matter of semiotic, and it is the same thing a person does when speaking, as he couples words and meanings. Meanings are the consequences of words.

Before the energy crisis, the operant code of architecture did not include the energy consequences of the design/construction acts. Our aim is to update this architectural code in order to improve the energy performance of buildings by changing the architect's mind connection between shapes and performances.

The designers that use the previous architectural code had no possibility of distinguishing those buildings which possessed the energy quality from those which did not. These two classes of buildings were not separated; consequently, there were no criteria to select among them the desired building for providing the now required energetic efficiency. The buildings able to deal with energy saving operations/performances were not distinguishable from all the others, or such loose distinctions among them were no more sufficient for the new emerging standard.

The problem we wish to solve is that of providing architects with the design equipment for distinguishing and selecting the energy efficient buildings. But instead of giving them the current testing "design tools" to discard the wrong projects already developed, we aspire to assist them in selecting the correct projects for development. It is very hard to convince a designer to eliminate a project after its development; it is better and possible to help him avoid developing an incorrect solution.



## THE REGIONALIST LANGUAGE METHOD

---

In order to influence the designer's selection at the beginning of the project, one should overcome the modernist concept of design emancipated from precedents. The only way to influence the initial choice of an architect is to provide him with the correct precedents, and typology is the method of organizing for designers these precedents. Because we are not so naive to suggest the simplistic reproduction of magazine photos, a new grammar has been developed to make the use of precedents more complex, in order to make it more efficient. We are not giving to architects the energy efficient precedents for copying; we should like to transfer the competence for "reading" the projects in order to distinguish the energy efficient ones from the others. Updating the present operant architectural code, which couples the architectural shapes with their energy performances, leads the designers to the "reading" of these consequences and, through them, to distinguish the energy saving buildings.

Following this approach of a generative typology, architects face two different kinds of precedents: the **architectural works**, that are the texts of the design language, and the **composition rules** with the repertoires of types, that are its grammar. (Prieto pointed out the distinction between the texts and the languages as the difference between the "code" and the "message"; the message being the sentence as pronounced or written by a competent user of that language, and the code being a system which becomes accessible only through a logical and systematic analysis of many sentences.) Texts and grammars enhance the distinction between the issues characterized by their positional order and issues defined by a combinatorial availability of discrete formal models whose possible assemblies are restricted by specific rules.

The architectural culture can list many texts but not the relative codes. The grammar we are developing tries to overcome this deficiency by adding to the architectural texts the architectural grammars (types, repertoires and composition rules).

Architects currently couple in a very rough way the building shapes with their related energy performances, but this connection is not sufficient. Its looseness cannot distinguish precisely the groups of buildings whose energy consumption is very low. They can recognize some loose relationship between the massing of a building and its thermal losses, the link between the size of a window and the light it provides as the connection of a beam with its related bearing capacity. A semiotic code relates these shapes to their performances (or consequences). We must improve the precision of this connection, making pertinent the energetic consequences of the building shapes. Heating, Ventilation and Air Conditioning (HVAC) equipment reduced the precision of this connection by assigning the climatization task to mechanical plants, thus making very loose the relationships between the building envelope shapes and the energy performances. Many modernist designers interpreted HVAC equipment as a tool to make architects free from the constraints of environmental requirements.

### 1.3 DESIGN PROCESS FALLACIES

The energy design tools developed in recent years to help architects involved in energy saving are primarily devoted to the simulation and evaluation methods dealing with an improvement of the environmental control of design. Reviewing the many published studies identifies the lack of those design tools whose aim is design hypotheses generation.

Two categories of published contributions to transfer the results of research work to the designers are apparent:

- the former includes some publications, collecting solar architecture examples developed for different places, which look like architectural magazines and books;
- the latter has to do with a number of handbooks dealing with the energy analysis tools, ranging from nomographs to computer programs, in order to provide designers with efficient analysis tools.

The kind of design concept, assumed beforehand in research on energy conscious design, is always characterized by an evolutionary process of trial and error corrections. The epistemological background of this evolutionary design process is based on the belief that creativity cannot be described nor improved through learning, that what is important is to test the performance of design proposals, it does not matter how they are generated.

In design education, one can observe a widespread diffusion of scientific testing tools; on the contrary, the argument of design solution generation is quite lacking. Also, following the discussions which have emerged from research teams developing passive solar design handbooks continually confirms this general design concept.

As a consequence of this belief, architecture is thought of as a result of cognitive processes otherwise performed, but not itself a cognitive process. The design problems should be solved using mathematical language and only later translated in architectural terms.

In this booklet we try to show that it is possible, and more interesting, to develop the cognitive potential of architecture, and its capability to deal directly with design problems in order to arrive at the best solutions.

### 1.4 CONTROLS OF DESIGN

When designing, an architect continually evaluates the alternative solutions he produces for various problems. Following the functionalist design concept we referred to above, it implies that every design judgment must be tested as if no knowledge exists from past experience. Any design step faces problems making a "tabula rasa" -- empty tablet -- of all the previous works and solutions, considered no more than dangerous prejudices.

We know today that without these prejudices, no design activity would be possible, and only a few stubborn modernists continue to support the uselessness of history. However, we lack a consistent theory embodying this new design concept.

When we accept judgments based on experience, we face a kind of codification which couples the shapes under judgment with their relative performances. In some way the shapes the architect is drawing represent the performance that he thinks they will provide after the construction. The reference of the shapes drawn by architects to the presumed performances, if stabilized by culture, assumes a semiotic role that allows for on-line judgments called semiotic ones. Factual judgments are, on the contrary, the off-line judgments whose content was not previously defined by a cultural codification. The functionalist design theory denies the contribution of semiotic judgments, based on the precedents of architectural typology, to assert as valid only factual judgments directly proved by tests. The program of engineering the architecture, pursued by the "building science" culture, strongly refused any rationality to the semiotic judgments of architectural culture.

But factual judgments were not carried out by architects, they were managed by engineers, determining the "divided self" of any building designer.

The passive solar design movement, dealing with the issues of transferring the research outputs to architects, met with this kind of problem.

This booklet attempts to overcome the "divided self" of passive solar designers and, at the same time, to contribute to the theoretic questions involved in architectural composition.

To become efficient, the semiotic judgments must be based on a codification made explicit by the study of architectural language. When an explicit codification allows for updating the relationships which couple shapes and performances, we recognize that engineering is more efficient in the revision of existing codes than in the daily practice of designers. We are not denying, of course, the importance of tests, i.e., of factual judgments, in the design activities, we only exclude the functionalist ratio between factual and semiotic judgments. We say that in the current design activity the judgments are mostly semiotic, and that the function of factual judgments should be shifted from the daily performance control of every shape to the research work for testing the validity of codes coupling shapes and performances.

We consider three alternative design processes which presume a kind of knowledge transfer from research to professional practice.

The first, which derives from the modern movement, begins with the definition of users requirements included in a design program, and it assumes that the designer is unaware of any architectural precedent. The design hypotheses generation is performed by architects or civil engineers, and the design solution evaluation is performed by structural and mechanical engineers, who test the proposed shapes, ascribing them, through simulation, the related performances, making only corrective interventions, adding mechanical installations but without changing the building envelopes.

# THE REGIONALIST DESIGN LANGUAGE METHOD

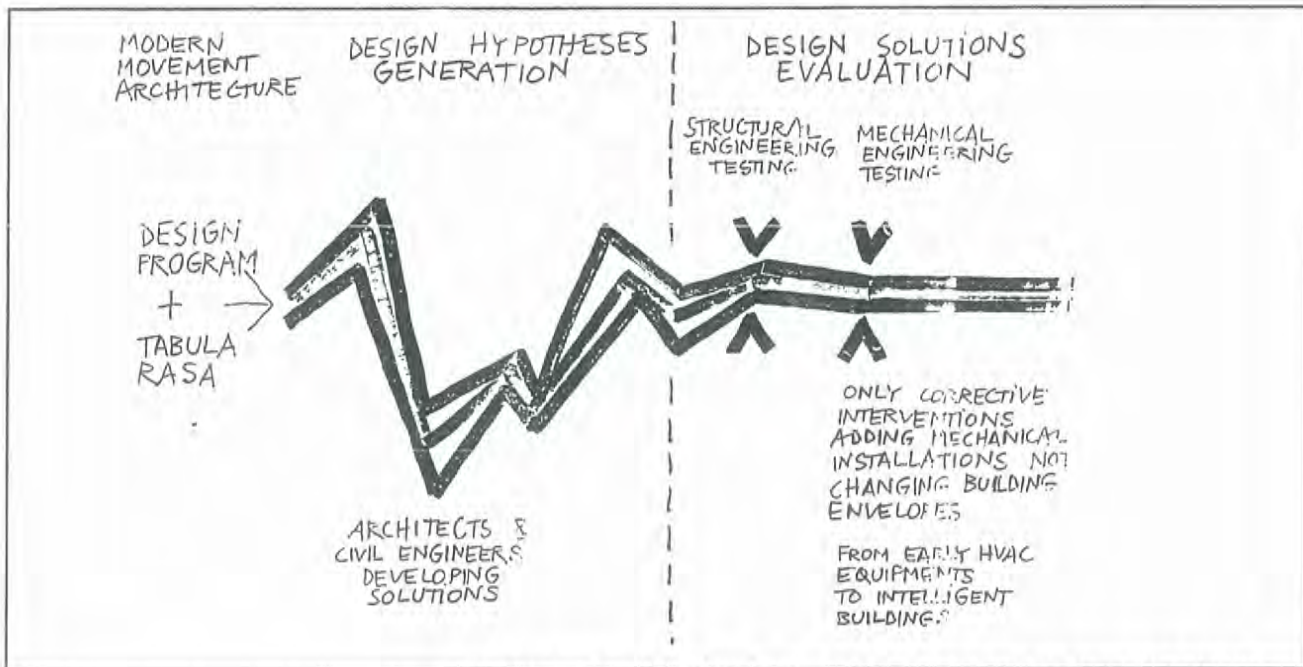

The second alternative design process is characterized by a feedback loop connecting the test outputs with the design hypotheses generation by an extreme simplification of calculations, in order to shift them to the beginning of the design process to feed design hypotheses generation. Generally, this effort caricatured technology trying to monumentalize its shapes, from the structural rationalism and brutalism to the pipes and wires exhibition of high tech buildings. The passive solar movement following this approach tried to pursue a thermal functionalism that should determine the correct shapes of buildings and simplify the calculations of the testing tools.

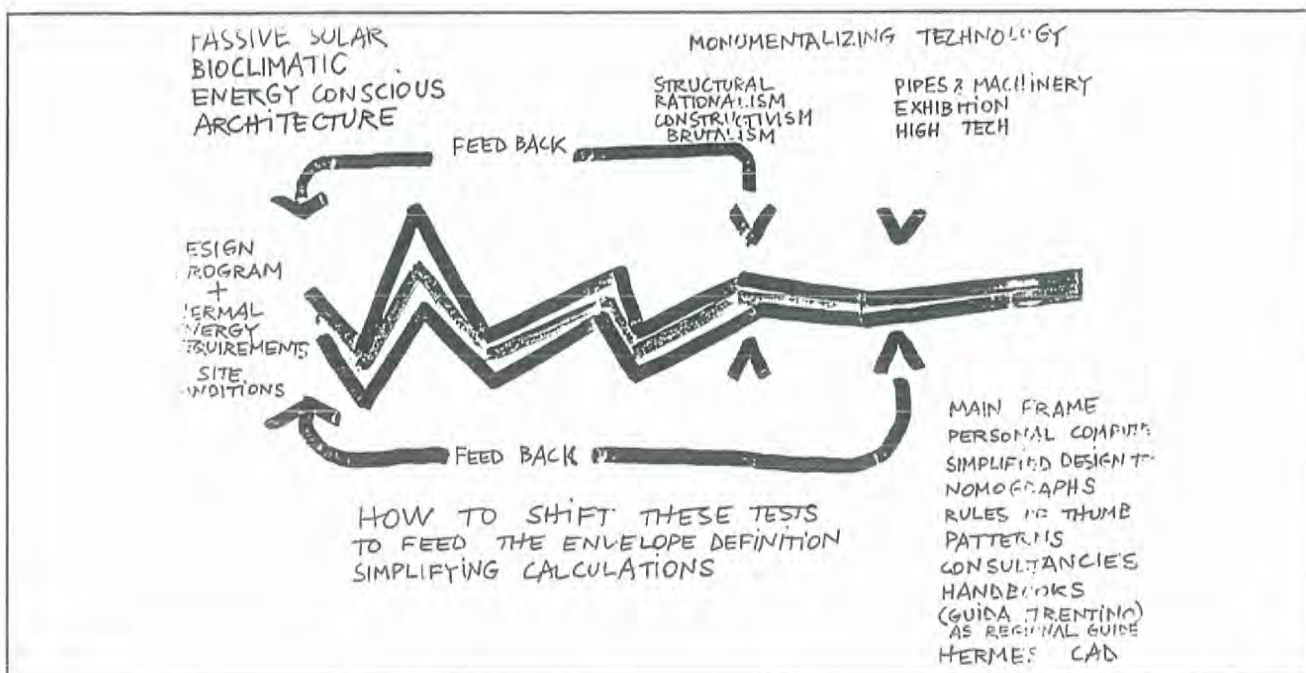

## THE REGIONALIST LANGUAGE METHOD

The third design process, the post-modern historicism, recognizes the limitations of the functionalist approach, limits the performance evaluations of building solutions to their operation, and enhances the design hypotheses generation searching out from historical or media precedents the shapes of buildings.

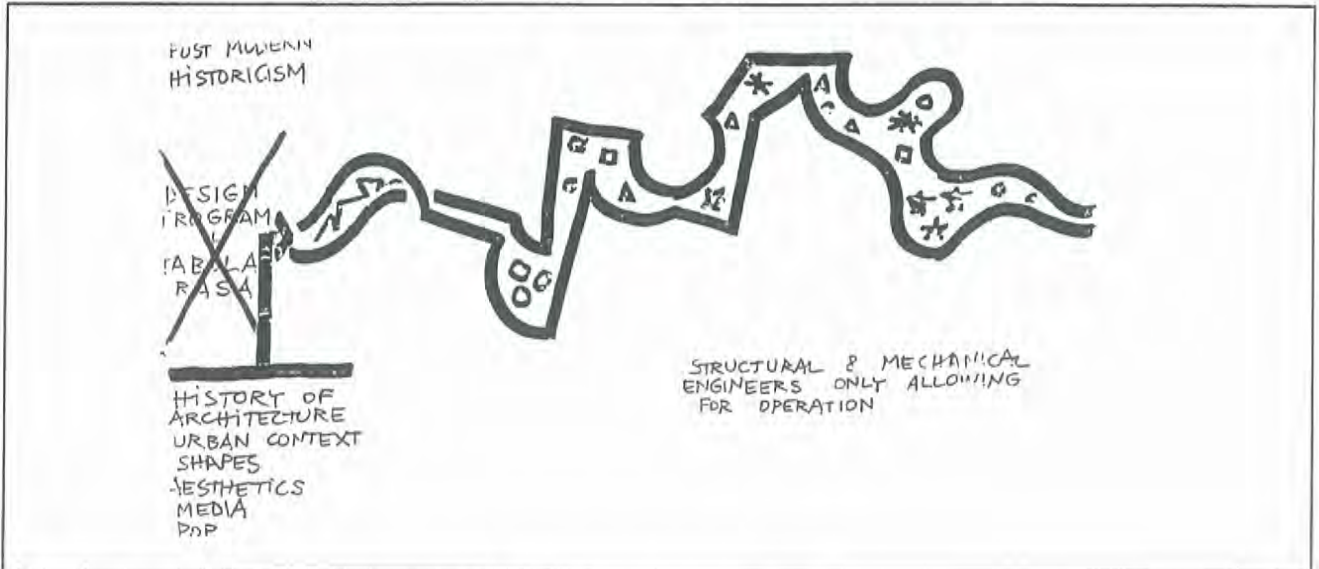

We suggest a design process consisting of two interlocked feedback loops connected by the architectural grammar interface, performing two different tasks: (1) improving the professional design processes; and (2) maintaining the architectural grammars by updating the codes of the design language.

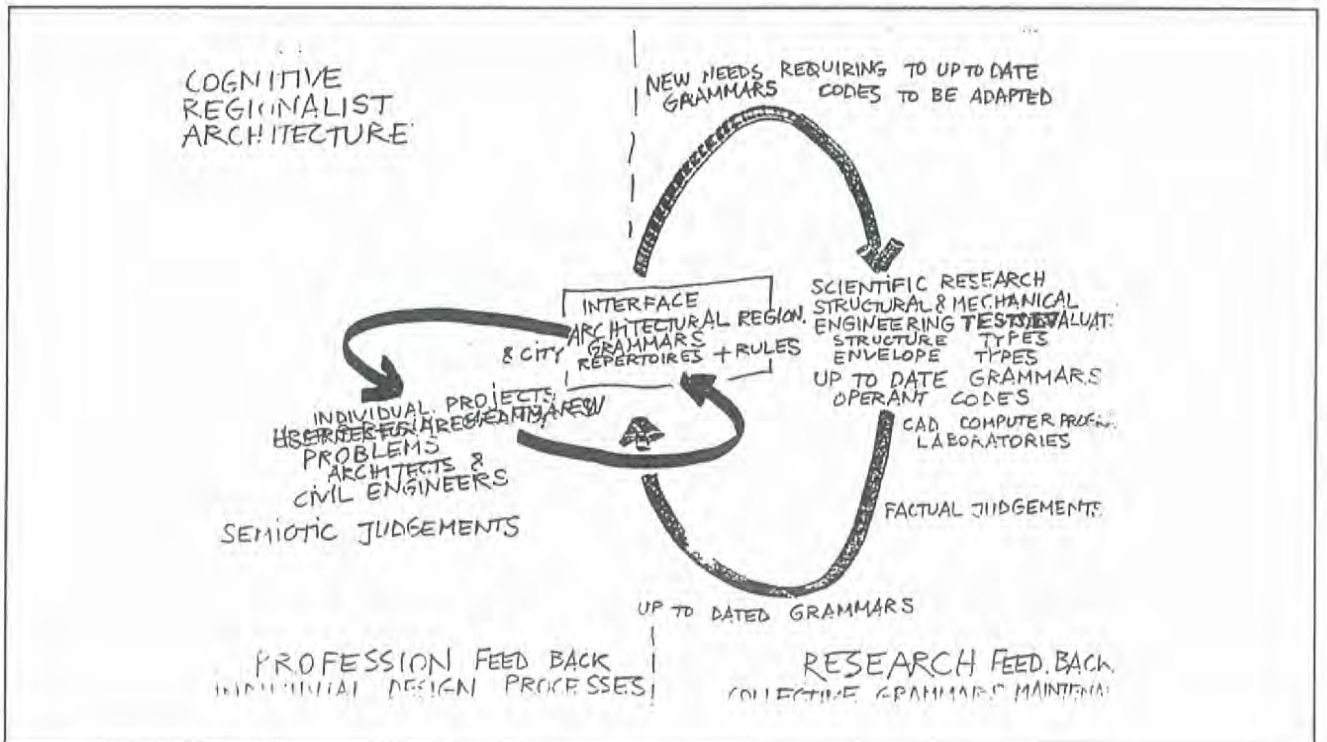

## THE REGIONALIST DESIGN LANGUAGE METHOD

---

The central issue is the transfer of competence in designing satisfactory buildings, considering energy performance and environmental quality. In order to transfer this competence, we must distinguish those buildings which possess such quality and those which lack it.

This distinction divides the set of all buildings in two separate and complimentary subsets; we need a tool to draw that distinction.

There are four ways to specify sets of projects possessing and lacking specific qualities. First, one can exhibit a catalog of the elements in the set. This method is impractical for all but small sets. Second, one can present one of the elements of the set and the transformations for generating, through a computer program, the other elements. A third approach is to provide some testing tools to eliminate all the elements lacking the defined quality, no matter how generated. A fourth approach, as presented in this booklet, consists of providing a grammar for generating elements of the set.

It is easy to recognize the second method as that of architects who are reproducing through loose transformations the architectural models currently published by the magazines; and the third one as the functionalist, engineered, building science pursuing the epistemology of an evolutionary, blind, trial and error correction process.

### 1.5 THE REGIONALIST DESIGN LANGUAGE APPROACH

Testing the validity of architectural codes requires an explicit definition of the structure of the design language. Studies on architectural grammars are not as diffused as many other topics in the design theory. The Design Language approach proposed here derives from:

- the typological culture of architectural composition developed within the treatises by the theoretic architecture;
- the "Shape Grammars" developed by Stiny & March dealing with design theory, artificial intelligence and computer aided design. ( )

The study of this grammar is based on two major issues:

- the repertoire of types, elaborated following the "Morphological Box" suggested by Zwicky, and applied in a study presented at the Passive Solar Conference held in January 1979 at San Jose ( );
- the rules for selecting, placing and transforming these types, elaborated following the geometry of transformations and the post production systems.

We will explain, shortly, this grammar, including also some examples of its application in our projects.

We give here an overview of the design language issues. The grammar that is described later consists of a set of composition rules and a repertoire of architectural types. We emphasize the transformation rules within the grammar because they characterize our proposal compared to others. The majority of treatises present some types included in repertoires, as examples of applied composition rules to be followed. This grammar, on the contrary, proposes a set of transformation rules to fit the types to a specific site and program. The contribution of geometry to the definition of these rules is fundamental. After Hilbert ( ), a geometry of transformations has been developed, integrating the different geometries in a system of geometric transformations, within which they are characterized by the different kinds of transformation processes. The composition rules of selecting, placing and transforming the types follow these geometric transformations.

Starting from a continuous architectural "text," a city, a village or any other settlement system, we must de-construct it to get discrete modules for recognizing its organizational structure and for performing comparative analyses. The element that allows these de- constructions of the architectural text is the precinct which draws a space distinction. Every site is defined by the partitions which structure the text system in a hierarchical array, where crossing the precincts one changes the scale of architectural module units. Doors mark the crossing of precincts defining the step from one level to another. Different kinds of walls characterize the relationships between the inside and the outside and among various enclosures. The wall is the element used by architectural languages to de-construct the settlement "texts."

The grammar is based on a syntactic structure which operates considering the fundamental relationship of a space subject, where the experiencing subject is, with other spaces, inside or outside, by the regulating mediation of different screens, fitted to the kind of interactions the subject wants to establish with them. The construction of some screens enclosing a space characterizes that space for its position and for the relationships it establishes with the adjacent spaces. This construction expresses an intentionality that can be confirmed or not by experience, corroborating or modifying its shape. As confirmed by the use, it embodies a knowledge about the site and the institution inhabiting it. This construction performs an inference process that can be supported by a building or by a drawing, the logical analysis of its content does not change "reading" the score in place of its performance. The construction is an architectural statement whose underlying structure can be used to articulate different hierarchical multiscale systems, from the room to the square, for example.

An architectural "text" is made up of a set of architectural "statements" whose general structure is that of the room, intended as the general form of a precinct. These rooms considered as statements can be found at various levels. We consider, following the indications of the studies on the building types, four typological levels:

## 6 ARCHITECTURE GRAMMAR

### 1.6.1 De-construction of settlement systems

- the room itself, for example, a living-room, a bedroom, and so on;

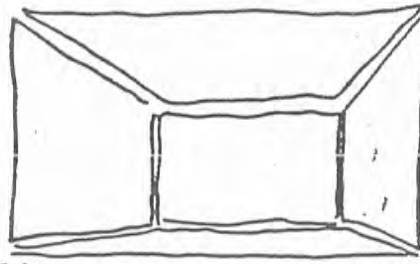

LEVEL I

- the building, which is a big room containing a set of smaller rooms in a specific way;

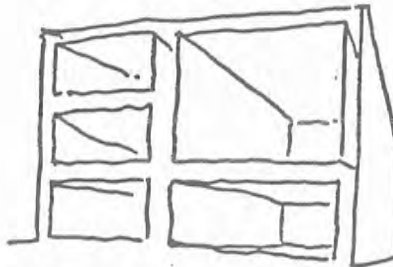

LEVEL II

- the street or square as a set of rooms without ceiling, which has the building facades as walls;

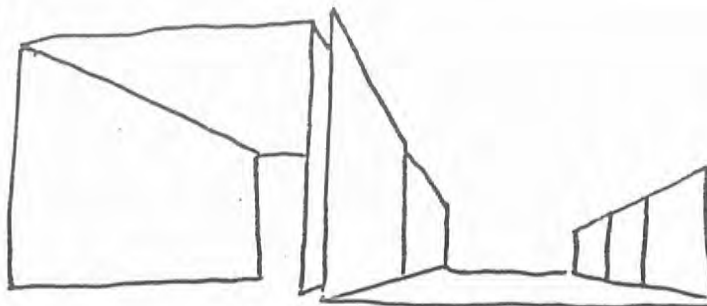

LEVEL III

- the homogeneous city part considered as an urban space-grid room assembling a set of street rooms.



LEVEL IV



## A TYPOLOGIC GRAMMAR

More levels, of course, could be defined, but these are sufficient for the multiscale architecture studied here. The language is developed to cope with a problem eluded by other architecture grammars; for example, the classical language that was developed more to handle architectural objects than to face the issues arising from a multiscale architectural system.

We can now remind the cognitive power of architecture made possible by its semiotic structure. What is the content of a knowledge supported by architectural rather than by verbal or mathematical language? What is the content of architectural knowledge? Architecture characterizes sites, it is a kind of toponymy defining the shape of the places, which, as names, makes them recognizable. But the places are defined through architecture as they are inhabited by humans. Any kind of life in these places is made possible through operations which require some specific tools. The relationship between site operations and the architectural tools which allow for them, is fundamental to understand that special type of knowledge we call architectural. When considering an architectural tool, as we think to use it in some way, we ascribe certain operations to it. This is a semiotic act. Architects must, on the contrary, design the architectural tool to whom ascribe the required operations.

Culture makes operations and their tools, institutions. The characteristics of architectural tools and their differences are very important to distinguish different institutions, and to realize different institutional tasks. The way by which the architectural tools are expressing the relative institutions, operates on the basis of a grammar in which one finds always a place/subject, where we are, and many other places/object around it, whose relationship with the place/subject is defined by an envelope, screening the interactions between them. It is this regulation of interactions between an inside and an outside which realizes the operation of an institution in its specific place.

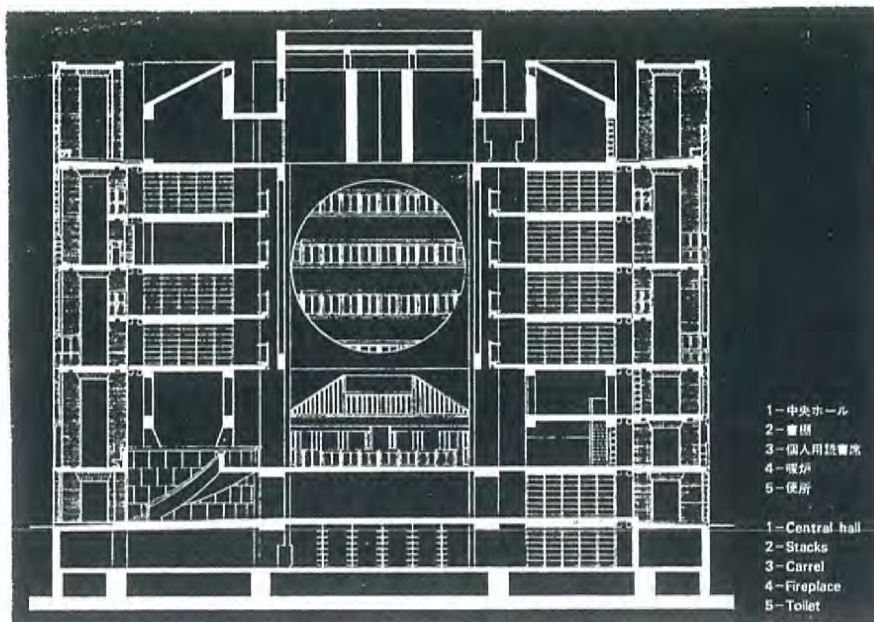

Realizing this regulation the architectural statement defines and distinguishes the specific identity of institutions and sites.

Nothing can give us, better than architecture, the knowledge of the specificity of a "library" as institution. For example, consider Kahn's Exeter Library to understand how the room as a statement defines the realm of site and human activity, mediating very sensitively the interactions through a pierced architectural envelope.

1.6.2 Room Structure

To explain the structure of the architectural statement, i.e., of the room, we can divide it into two components: the Site Group (SIG) and the Shelter Group (SHG). The Shelter also includes those places towards which it realizes interactions. The grammar allows, through various kinds of productions, for selecting and placing the types taken from the repertoire, and for adapting them through modifications, composing the variety of rooms we need and like.

The room is a cell articulated in planes, forming polyhedra. Cells, Faces, Edges and Vertices of these polyhedra follow a rule invented/discovered by Euler, which gives us a kind of combinatorial syntactic characteristic, defining the types that come into play.

$$\text{Vertices} - \text{Edges} + \text{Faces} - \text{Cells} = 0$$

(valid for a three dimensional space)

For a cubic room  $V=8$ ,  $E=12$ ,  $F=6$ ,  $C=2$ , the 2 cells are the inside and the outside of the room. To map it in the drawings, we need 1 Face for the plan layout, which belongs to the Site Group (with its internal partitions), 5 Faces for the walls and roof, which (with their outside spaces) belong to the Shelter Group; 4 Edges realize the ground connections, another 4, the corners joining the pierced walls and the last 4 edges, the roof connections; the Vertices too can be defined as the extremes, downwards and upwards, of the wall corners.

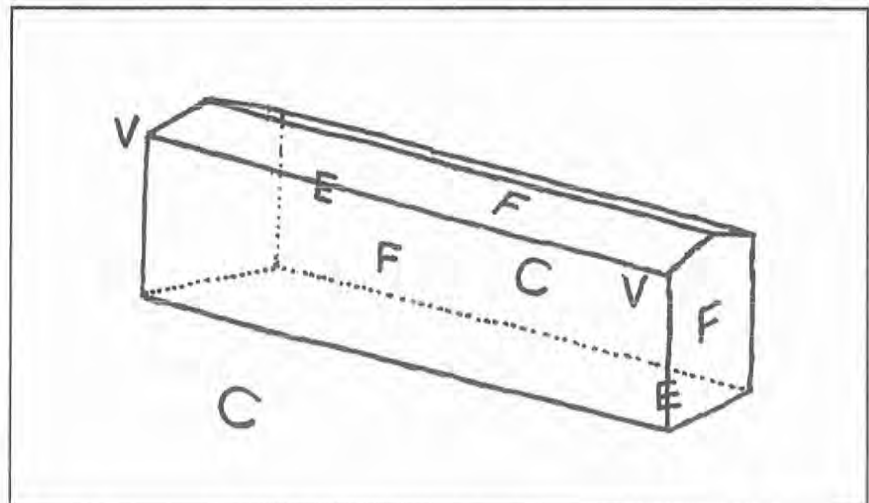

# A TYPOLOGIC GRAMMAR

Faces, Edges, Vertices, which compose the room Cell to divide inside and outside, are collected and ordered in the types of the repertoire, characterized by their performances. The coupling of shapes and performances allows for a correct selection of types, having in mind the codified relationships between the architectural tools and the relative institutional operations.

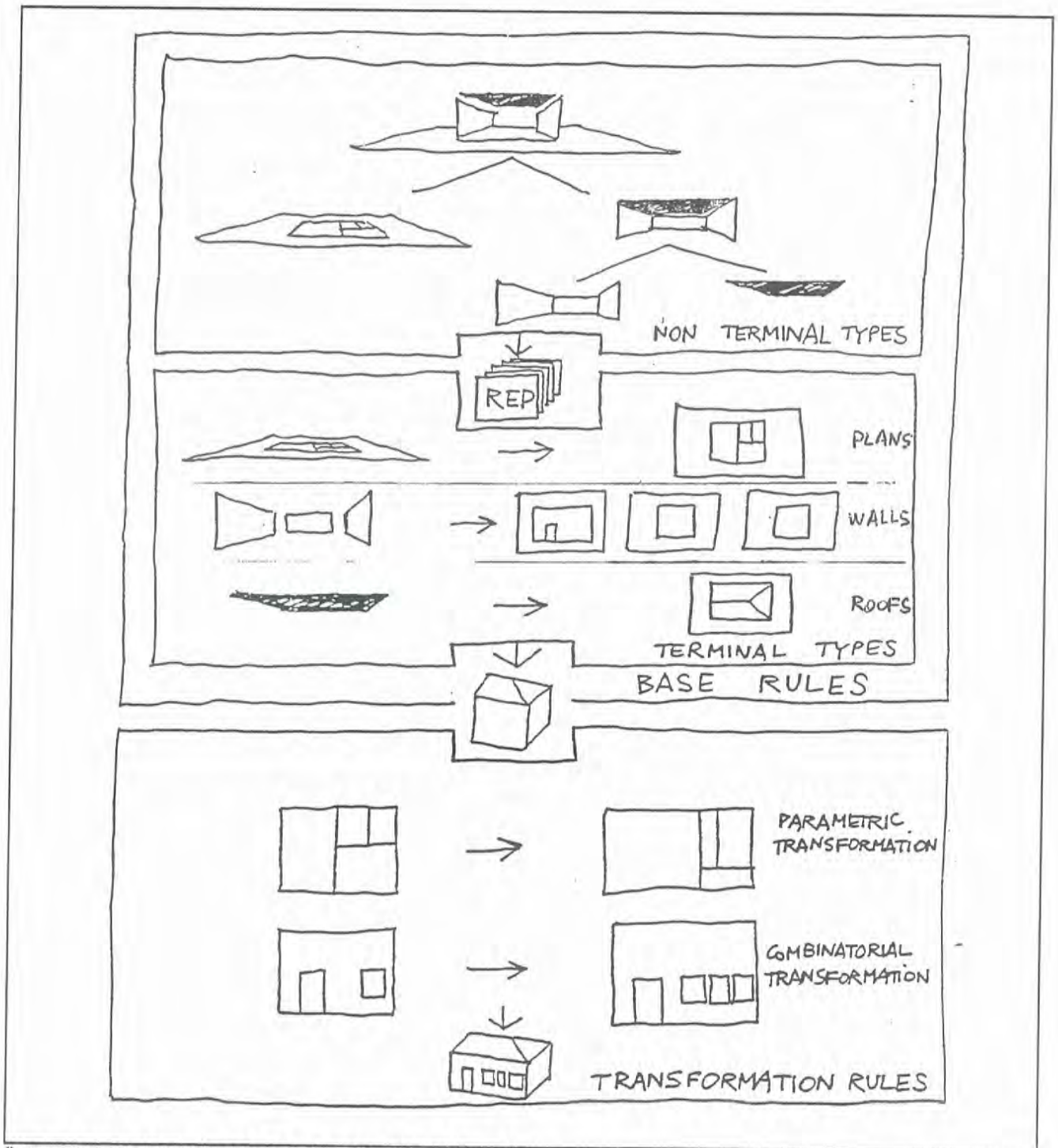
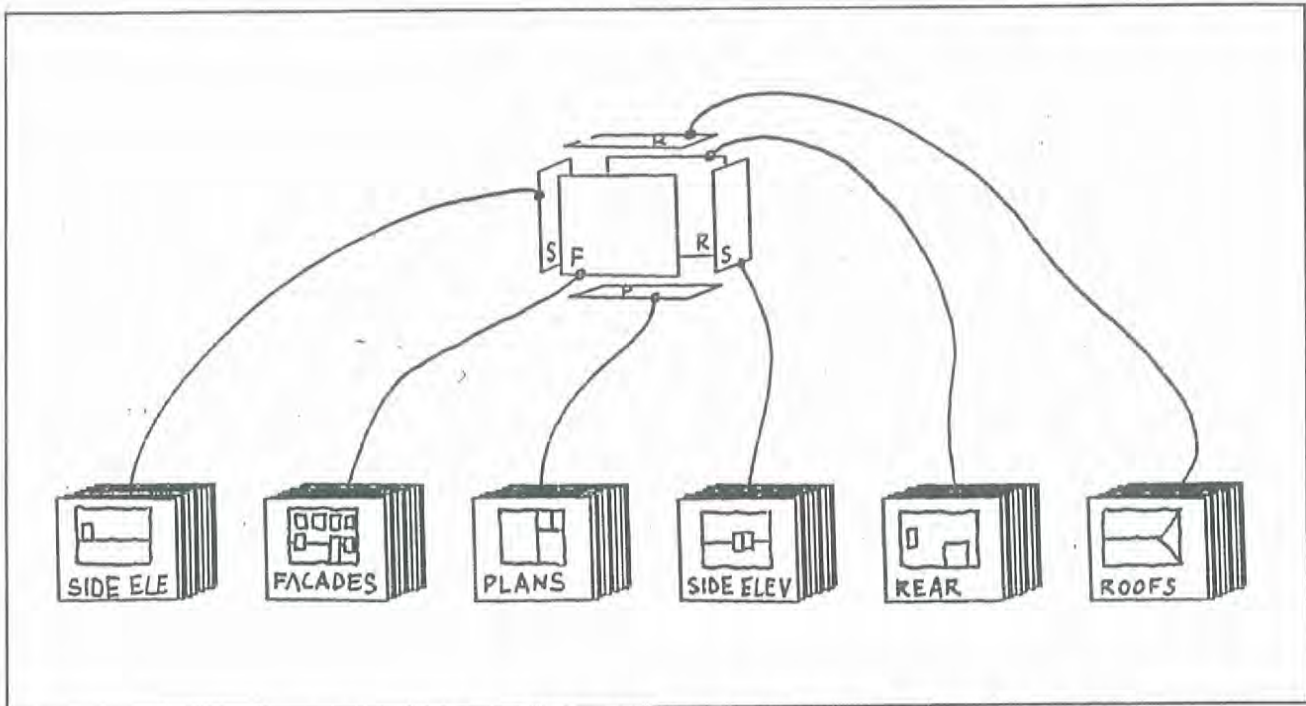

fig non terminal, terminal base rules, transformation rules

Cells, Faces, Edges, Vertices are collected in the repertoire as drawings, following the architectural system of notation, which map in two-dimensional layers (the sheets of paper, for example) the multi-dimensional characteristics of real buildings.

The continuous space of architecture is made discrete by the design theory that, since the early renaissance, decomposed it for mapping its characteristics in the drawings. These mappings, published in the treatises, and today in books or magazines, are the typological models collected in the repertoires, which architects use in order to select the building types for the generation of design hypotheses. These repertoires include: plan layouts, elevations, sections, etc.



The cell distinguishes two spaces, the inside and the outside through an envelope, made of variously oriented screens that are fitted to the different interactions of the single inside space with the plural outside spaces. In architecture, the spaces are three: (1) the inside regulated space, (2) the outside air space, and (3) the outside earth space. The cell/room is always within the earth space, a hole in its continual three-dimensional extension, shaping the surface which distinguishes earth and air spaces.

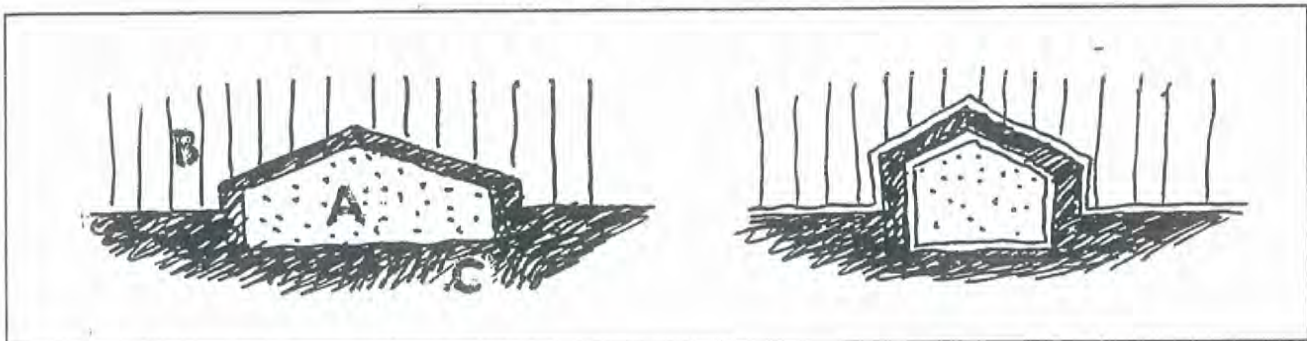

THE TYPOLOGICAL GRAMMAR

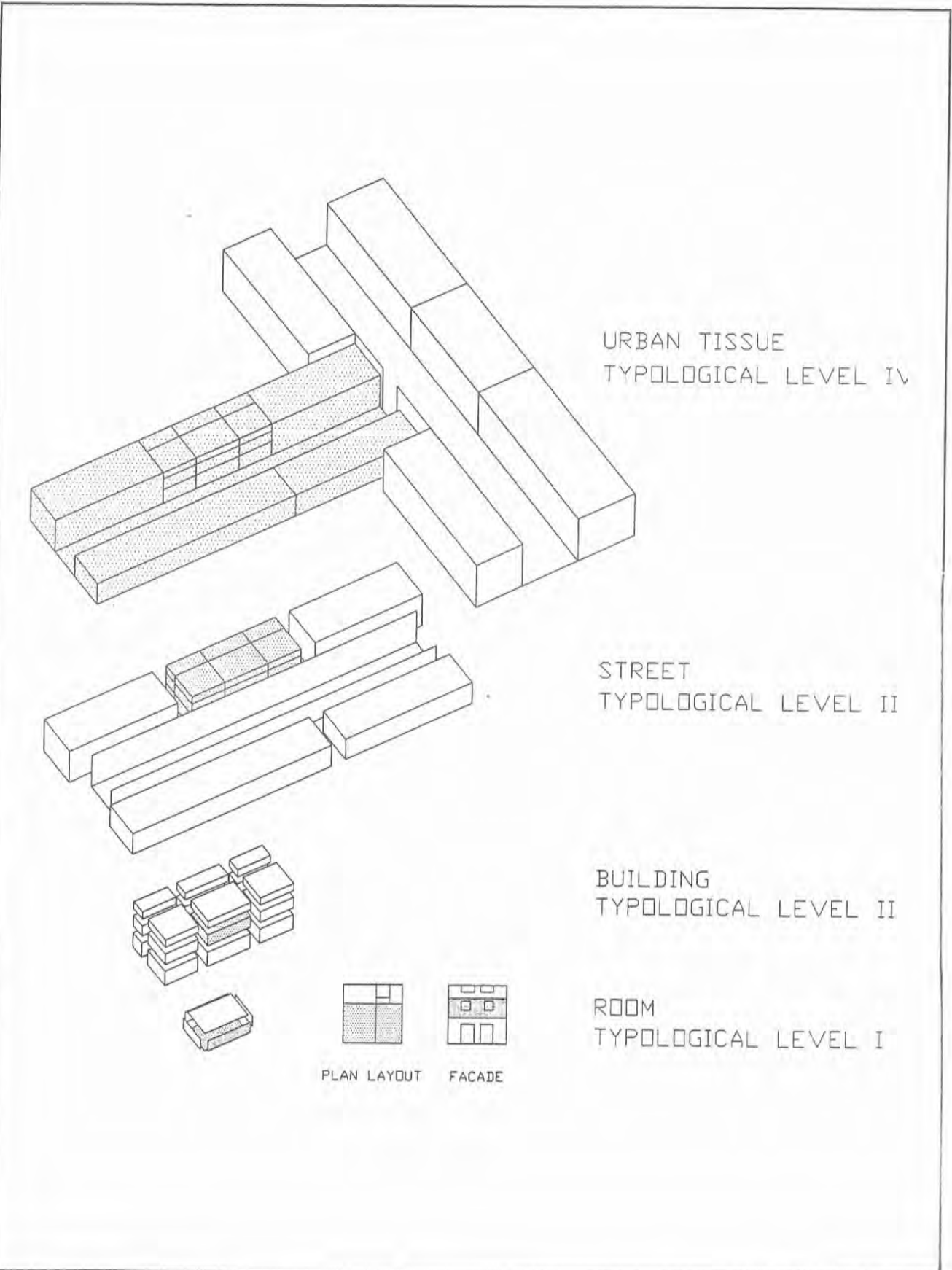

A room may be seen as a set of planes forming the floor, the walls with apertures, the roof, etc. Combining various planes, we can produce many different kinds of rooms. The planes composing these rooms are the "parameters" of the "Morphological Box"; the various possibilities for floors, walls, roofs, windows, doors, corners, etc., are its "variants." The combination of a floor with a wall, pierced by apertures, and a roof, that is of a set of parameters, realizes the syntactic relationships in the language, the collection of variants belonging to the same parameter, grouped together in the repertoire, realizes its paradigmatic relationships.

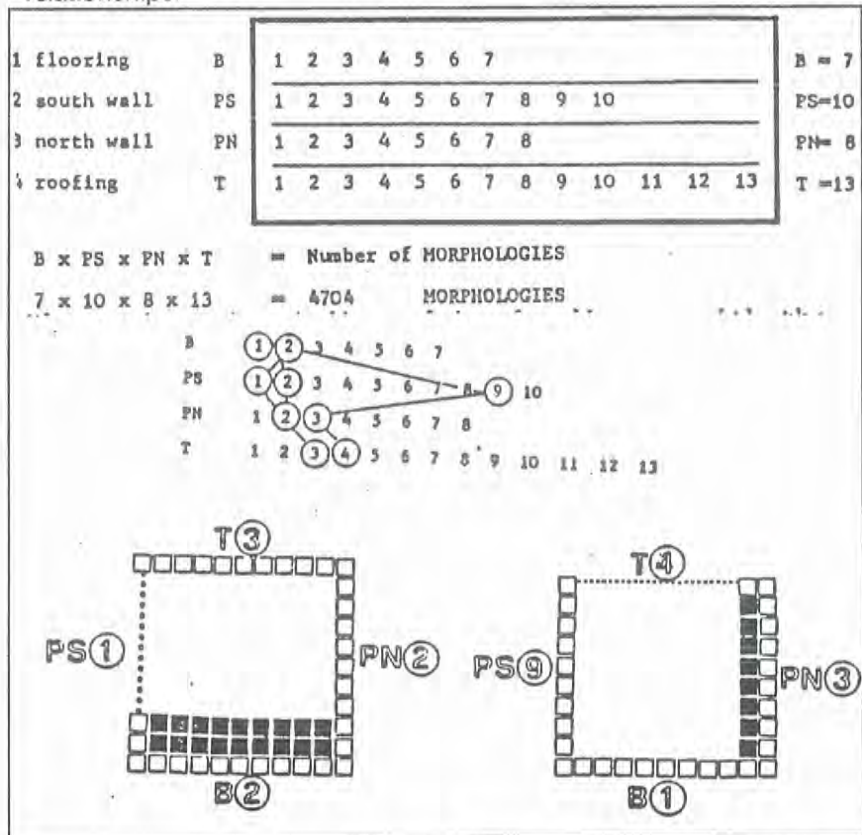

Every plane, which maps one type of our repertoire, must be intended as a formal model and not as a material sign. Its invariant shape is a kind of dimensionless pattern, reproduced many times in its tokens that occur in actual projects. The typological models, which constitute the repertoire of our grammar, generate formal entities and not material ones as the prefabricated components of a modern building or the columns and entablature of classical orders.

The plane, which enters in different combinations to shape a room, can be subject to a component analysis. We can recognize the "Constructive" and the "Stylistic" (or Formal) characters, acting as syntactic markers, then recognize the Distributive and the Environmental characters, acting as semantic markers. The former concerns the "grammatical rules" of architecture, providing for a correct construction fit to some institution or organization; the latter concerns

## A TYPOLOGIC GRAMMAR

the "logic rules," providing for adapting the construction to a specific institution in a specific place.

Bioclimatic rooms are made up of the same planes, the only difference is in the correct selection of floors, walls and roofs adapted to the site climatic conditions. Pursuing this adaptation, bioclimatic design strongly enhances the anisotropy of architecture; its differences between downwards and upwards due to the gravity field, together with the differences between facades and rears due to the urban field, are enriched by the bioclimatic differences between sunny and windy fronts. This anisotropy is very important in characterizing the type-planes of the repertoires and their composition rules.

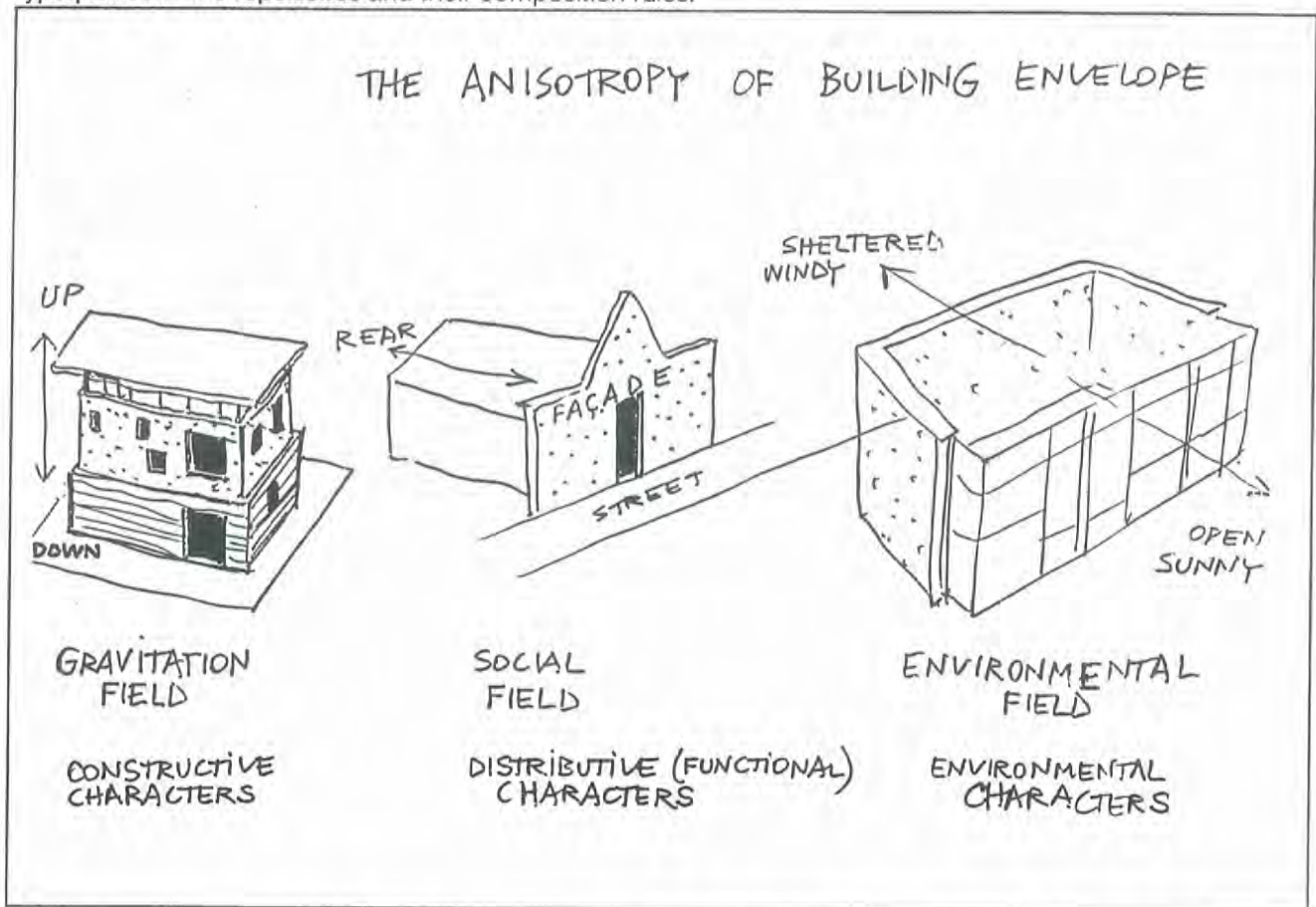

Rules exist to avoid the use of walls in place of floors and vice versa. These are called "grammar rules." Other rules, to avoid the use of walls designed for one region in the place of walls designed for another region, are called "logic rules." The latter rules are more restrictive than the former ones, because they are not only asserting that a room could be good for some place, but that this room is good for this specific place. Hence, there are two dimensions for the architectural quality, the grammatical and the logical correctness of architectural "statements," i.e., rooms.

### 1.6.3 SITE GROUP (SIG)

The planes, which constitute the room and make discrete the continuous space of architecture, are defined within the system of notation of architecture. They are elements whose task is more important than the simple mapping of building components to transfer instructions into the building site. These elements structure the architecture grammar, providing for a system of position roles which allows the construction language to go beyond the taxonomic state to reach a propositional state. The role of the plan layout (a foreshortening horizontal ground-plane, never seen as we look at it on the drafting board) is quite different from that of the facade (a frontal vertical plane which is parallel to the picture plane, hence seen as we look at it on the drawings), and from other representations (end elevations, sections, etc.).

The repertoire collects shapes which include plan layouts, elevations, facades, roofs, etc. These are "modules" whose combination forms the types. Only the types, which are the various level "rooms," can provide for particular performances. A roof, a facade, a plan layout, etc., without constituting a room through specific spatial relations, cannot supply the dwelling performances. They provide for other performances, such as the transmittance of walls or glass, which determine the environmental ones, when composed within that specific combination of planes forming a room. The idea that a module too has a performance derives from the habit of using it nearly always in the same combination to form a room, so the module presupposes the type within which it is often included, as the part often presupposes the related whole.

We will consider, to exemplify the concept, three classes of modules: the plan layouts which belong to the site group modules, and the elevations and the roofs belonging to the shelter group modules.

The plan layouts we consider in the following sections are those which have been developed by passive solar designers: the triangular house, the unilateral apartment block, the house within the house and the glazed courtyard. They are studied as relatively independent elements; therefore, they could be combined with various elevation modules or roof modules.

#### TRIANGULAR BUILDING

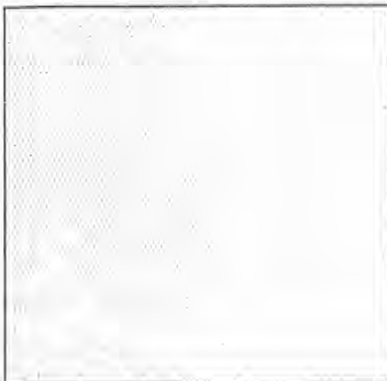

Consider the evolution of a building form through a process that begins with an architectural form, proceeds through a series of energy controls, and ends again as architecture.

Compactness is an objective that should be systematically pursued in formulating energy conserving buildings. The cube, as previously described, is the most compact, hence most optimal building form, with the least possible surface/volume ratio (excluding that of the sphere). In truth, however, it qualifies as the optimal, most compact form, assuming that all of its sides have equal transmittance, which would be possible only if it were to float in mid-air.



## A TYPOLOGIC GRAMMAR

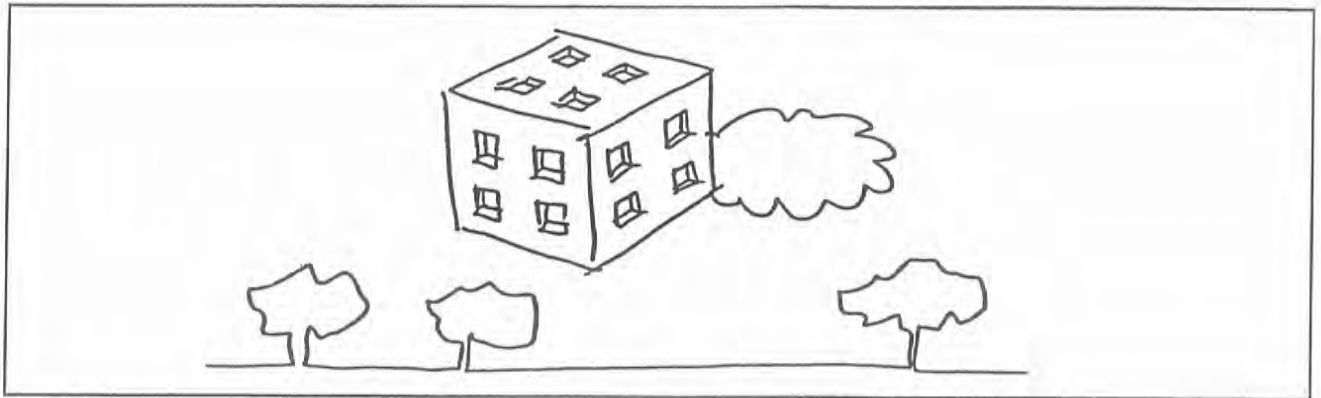

When gravitational force holds the cube to the earth, and rain and snow fall upon it, the transmittance of the floor and roof become less than that of the vertical walls. The optimal form then is no longer the cube, but a square plan parallelepiped whose height is less than the plan side. The anisotropy due to gravity, which differentiates the constituent plane surfaces, hence alters the optimal, compact form.

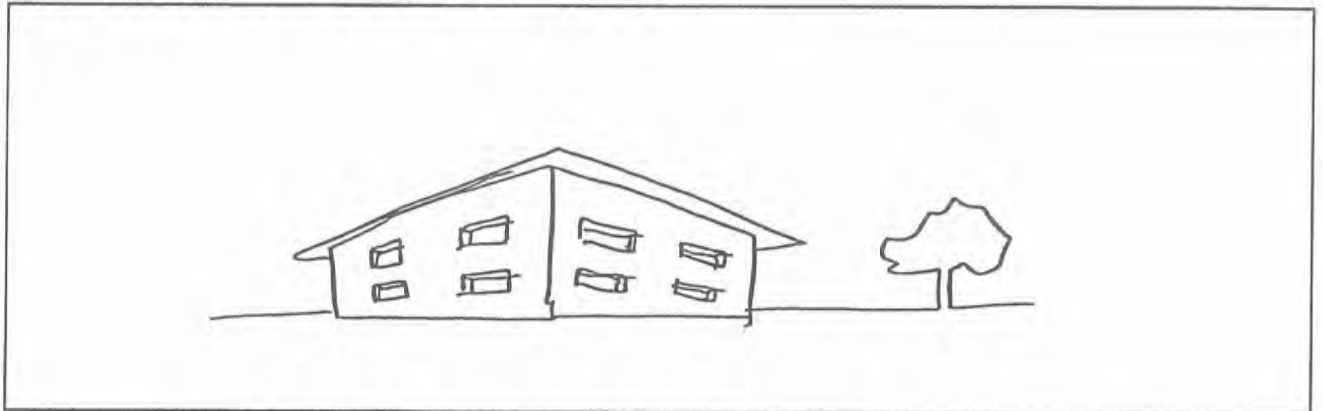

But we next discover yet another anisotropy due to the sun, which further impacts the form. As the south-facing wall gains energy from the solar radiation falling upon it, compensating for its heat losses and becoming less dispersing in comparison to the other walls, it becomes larger than the north-facing wall, which loses heat without gaining energy. The resulting shape is that of a trapezium or of a triangle, whose sides are determined by their transmittance.

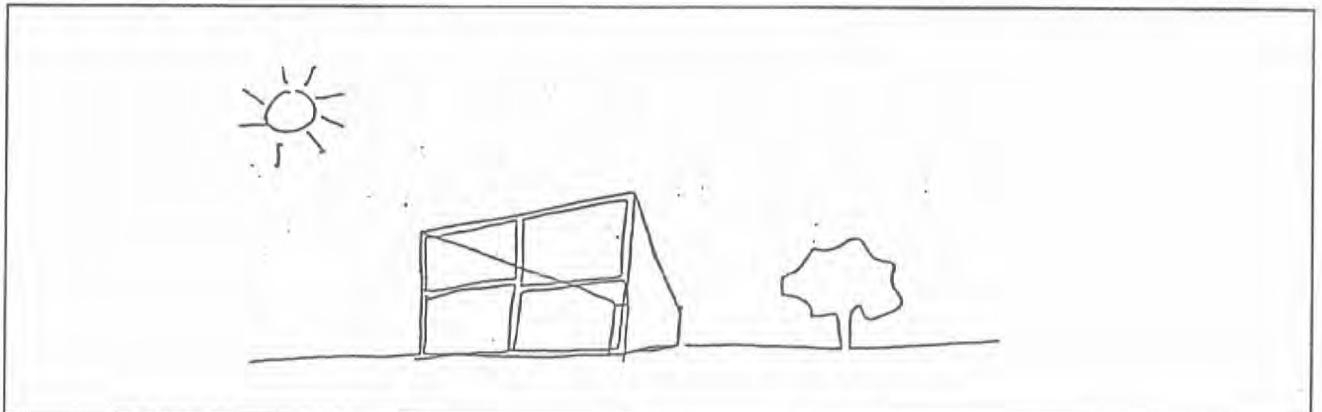

One last anisotropy affecting the south facade is that between the morning and afternoon. The changing temperature of the building's thermal mass causes an irregular indoor climate during the changing hours of the day, as the sun makes its path from east to west across the southern part of the sky hemisphere. The building's geometry again can be manipulated to solve this problem. The trapezium or the triangle can, in fact, be angled asymmetrically in response to this last anisotropy.

RALPH ERSKINE, GADELIUS HOUSE, STOCKHOLM, SWEDEN

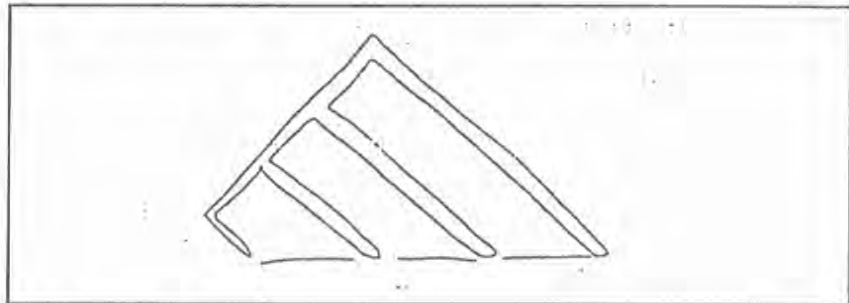
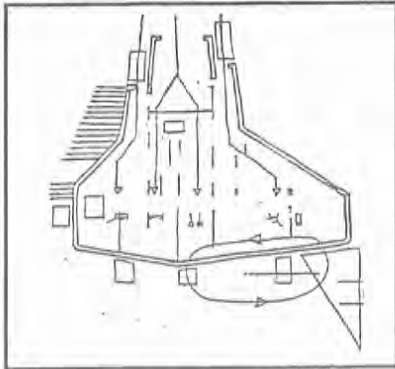

The designs that follow demonstrate some architectural derivations of the Triangular Building Typology.

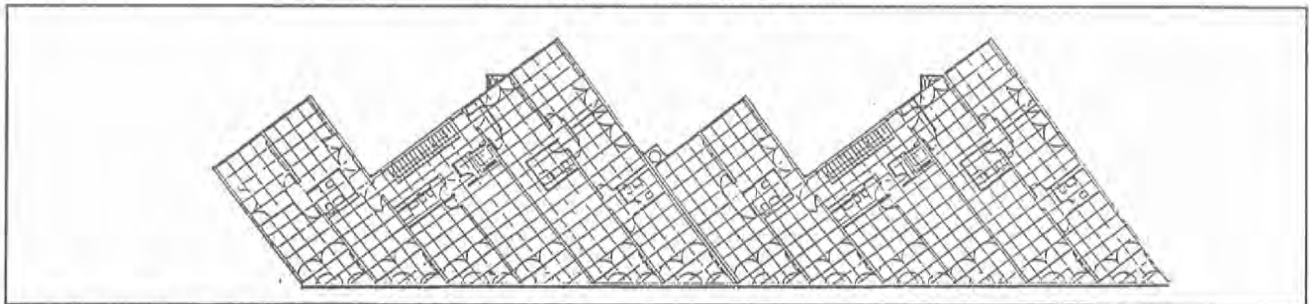

S. LOS, MULITY-FAMILY HOUSING PUBLIC HOUSING PROJGJECT (IACP), CAORLE, 1980

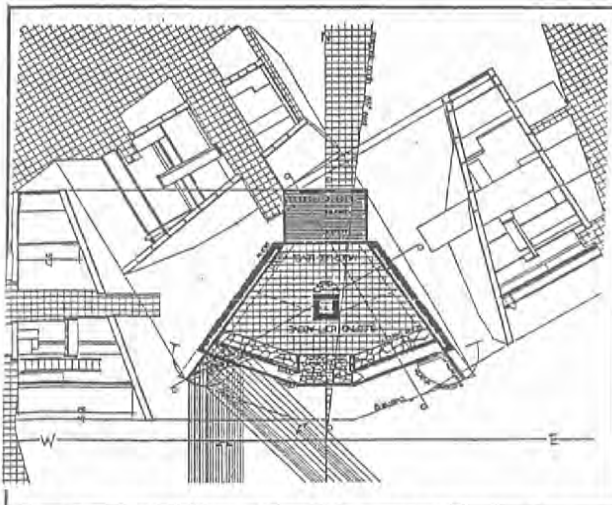

J. LAMBETH, MOUNTAIN CABIN, NEWTON COUNTY, ARKANSAS

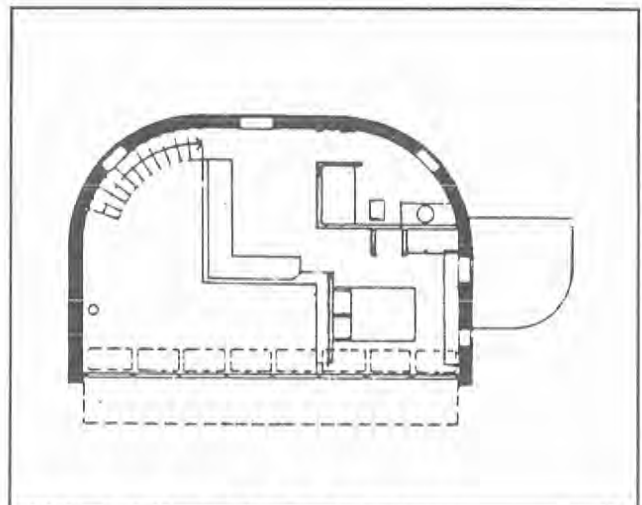

D. WRIGHT HOUSE, SANTA FE, NEW MEXICO,

## A TYPOLOGICAL GRAMMAR

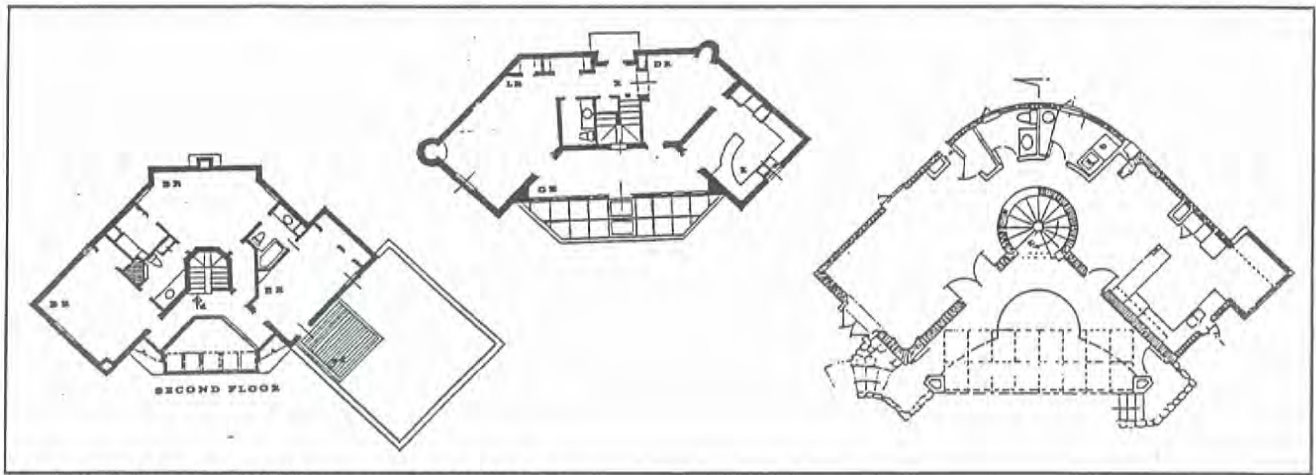

W. Lumpkins, variations on the "V" plan.

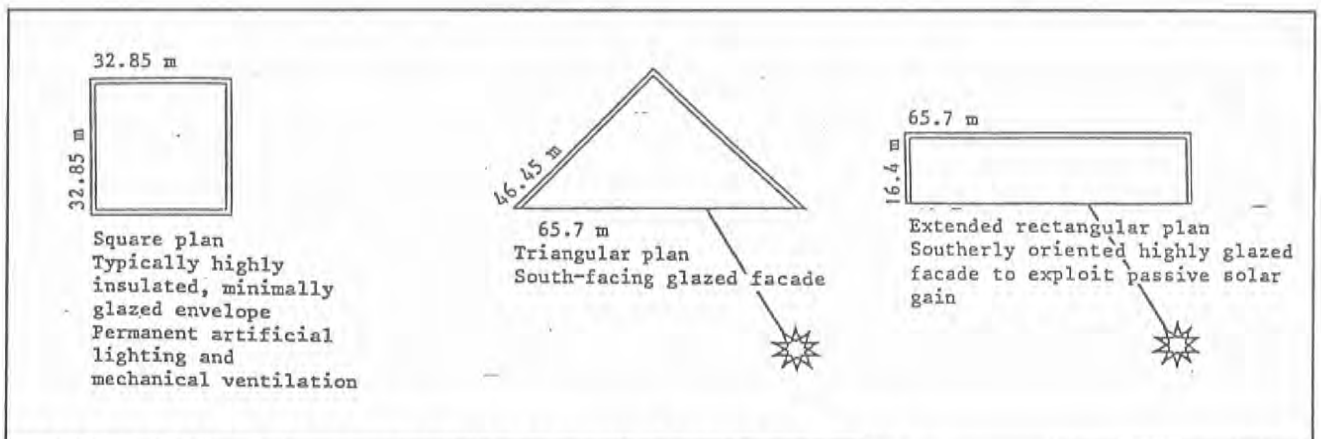

A COMPARISON BETWEEN THE ENERGY DEMAND OF DIFFERENT PRIMARY BUILT FORMS

D. Hawkes, in **Building Shape and Energy Use**

The following description of this bioclimatic building typology was developed through a comparative study on the energy performance of various building types /4/. In order to carry out the study, it was necessary to reduce the complexity of the extensive number of possible building types, using a single module combined in accordance to formal languages to obtain an array of building typologies.

The base module, representing a "dwelling unit," is graphically shown by projecting a parallelepiped on a plan in such a way as to generate a Schlegel Diagram. The thicker lines indicate the faces of the parallelepiped adjacent to others. Analyzing the possible combinations, we obtain 24 modules.

UNILATERAL APARTMENT  
BLOCK

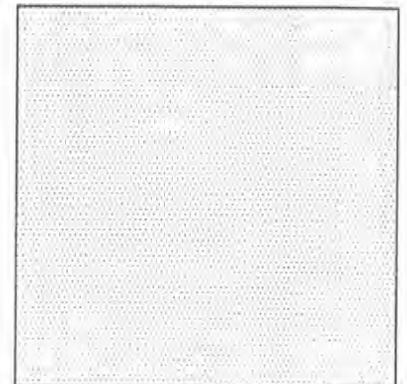

# A TYPOLOGIC GRAMMAR

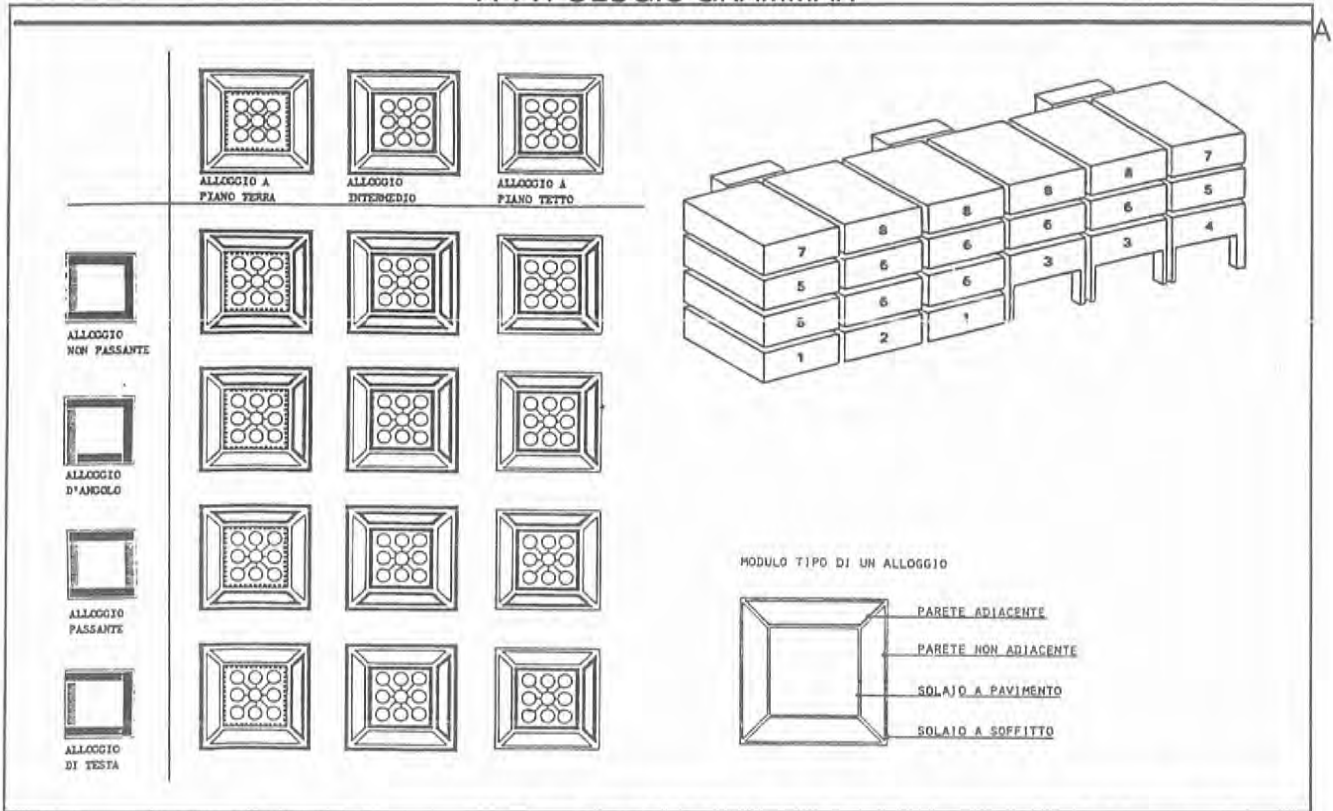

The building typologies are then generated by combining the subsets of the module configurations. The two-family house, for instance, is obtained by putting two modules together, horizontally or vertically; the row house, with several adjacent modules; the tower, by stacking the modules horizontally; and other types of apartment blocks with horizontal and vertical combinations. Ordering the typologies, we can identify a continuous series of building forms, and the specific correlation of building type to energy behaviour through simulation of their energy performance.

LOS S., L. AGNOLETTI, E. FORNASIERI, R. SINDILI, G. TRAPANESE, R. ZECCHIN - 1979 - **Comportamento energetico e morfologia edilizia** in Atti del II Seminario Informativo CNR/PFE - Peg Editrice, Milano.

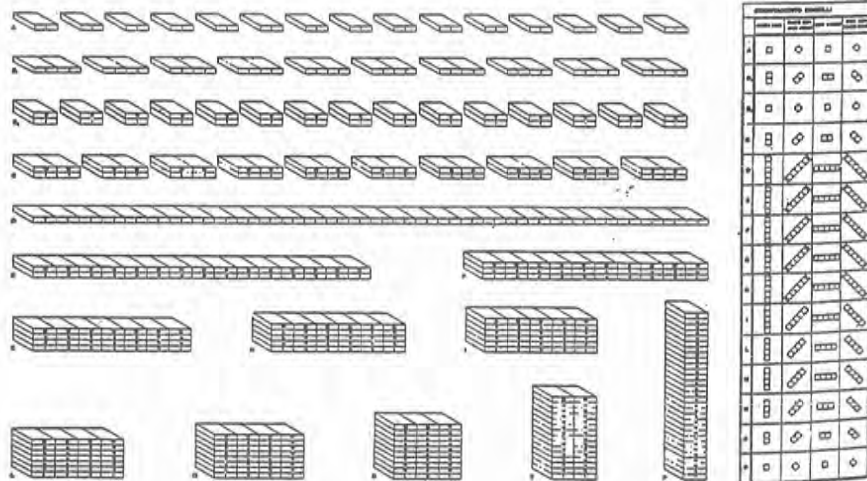

## A TYPOLOGIC GRAMMAR

The effect of orientation is next analyzed, simulating each building type from a north-south to an east-west axis. The building energy simulation output indicates that the apartment block elongated on an east-west axis corresponds to the minimum comparative energy consumption. Hence, the Unilateral Apartment Block is derived as a valid bioclimatic building form.

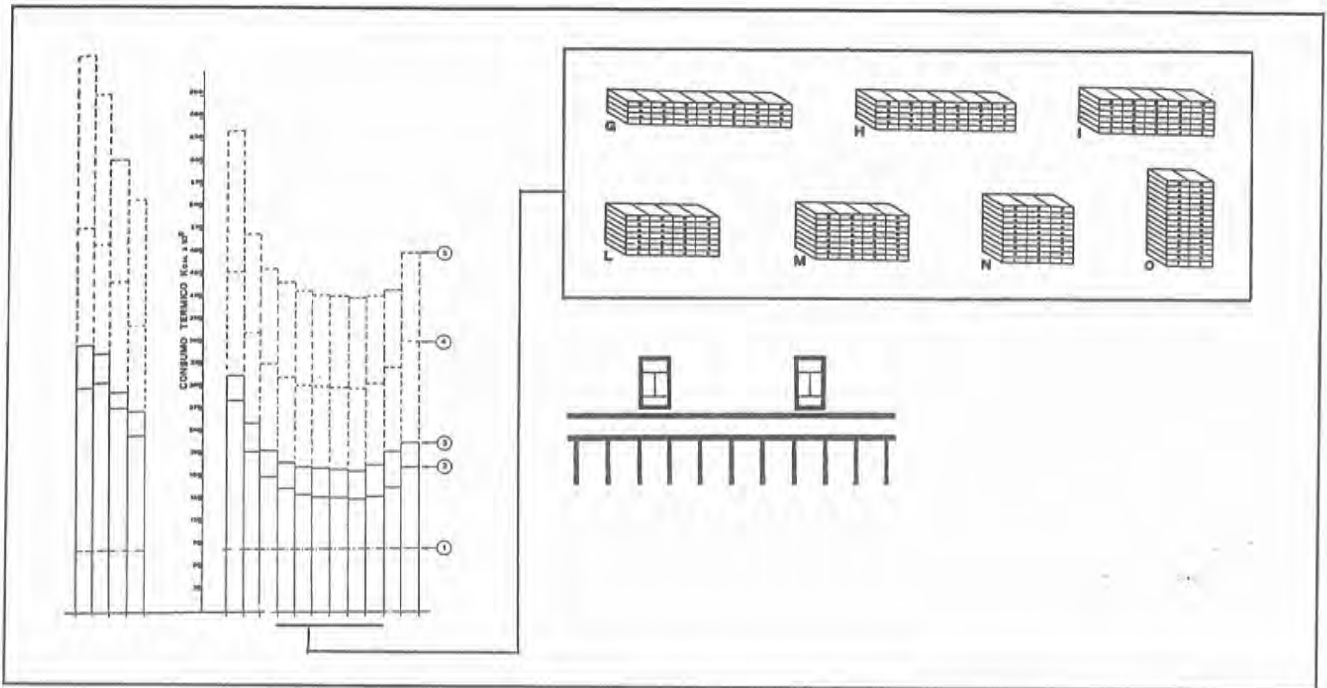

The evolution of the Unilateral Apartment Block has been studied through various examples of the Modern Movement.

Rejecting the 19th century concept of the "Rue Corridor," in which buildings were oriented to conform to the layout of streets and squares, Modern Movement architects looked to new criteria for building orientation, independent of a given urban layout.

Rationalist planners of this era sought to provide all city dwellings with an equal number of sunshine hours. This pursuit is most explicitly described by the work of Gropius, who analyzed the organization of urban space by relating orientation, height and distance between buildings, and expressed these relations mathematically. In an attempt to increase housing density and to balance sunshine exposure on both main facades, Gropius' Theorem expressed land use as a function of sunshine. Concluding that buildings of 10 to 12 stories allow a greater density than medium and single-family buildings, and that both facades of the building must benefit from at least 2 hours of sunshine on the winter solstice, he determined that the distance between north-south oriented blocks must be 1.5 times the height and 2.5 times the higher density, thus a lesser spacing. The first modern movement definition of an energy conserving building type resulted as the bilateral, high-rise and compact multifamily apartment building oriented on a north-south axis (known as the heliothermic axis (1906-1920). Obvious

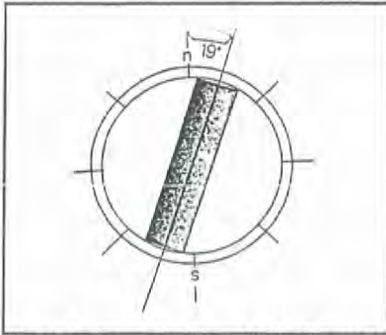

Variations of the Heliothermic Axis: a) Rey, Pidoux and Barde  
b) G.Vinaccia

shortcomings of this solution manifested themselves in a lack of usable solar gain, especially during the winter months, and in problems of morning, afternoon and summertime overheating.

The concept of the heliothermic axis was gradually refined, first by Rey, Pidoux and Barde who shifted the north-south axis to the east to thermally balance the two facades, and later was more radically altered by G. Vinaccia (1946-52) who developed the "equisolar orientation," determining the principal axis by the sun azimuth at sunrise of the summer solstice.

The "Solar Orientation," consistent with the bioclimatic design concepts developed and consolidated over the last few decades, basically replaces the Modern Movement's concepts of building orientation.

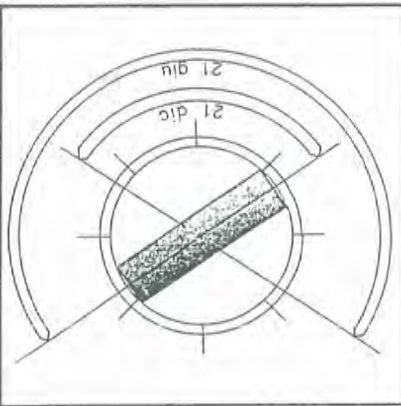

This changing priority for building orientation is mirrored by a change of appropriate building typology. While the heliothermic axis dictated a bilateral building (i.e., living units facing both east and west circulation and utilities centered within the building along the main axis), the building type most adaptive to an east-west axis is unilateral, shifting the utility zones to the north and stairs to the exterior to allow all of the living quarters to benefit from the solar gains of the south facade. This latter pattern provides a maximum collection of radiation in winter and mid-seasons and the possibility to protect the building from summertime overheating by using simple overhangs and shading devices.

C.1 S. Vincenzo



C.2 Certaldo

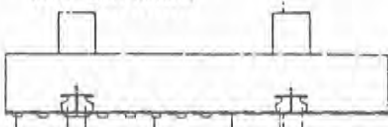

C.3 Forte dei Marmi

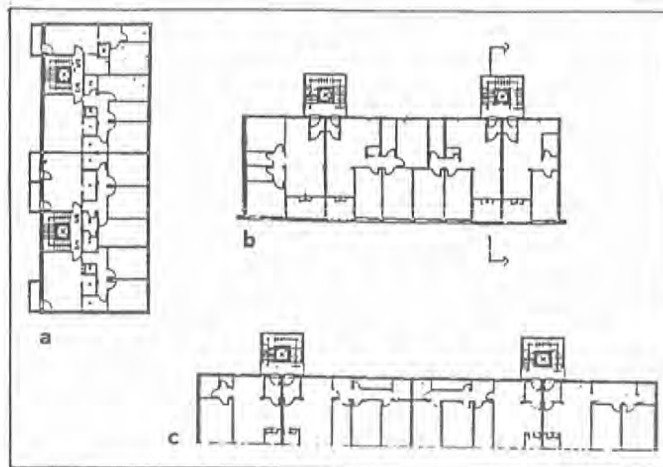

VARIATIONS OF THE UNI-LATERAL APARTMENT BLOCK WITH DIFFERENT PASSIVE SYSTEM APPLIED TO THE SOUTH FACADE, RELATIVE TO THE RADIATION AND TEMPERATURE CONDITIONS OF THE CLIMATE (:A) AVERAGE RADIATION AND TEMPERATURE VALUES: COMBINATIONS OF DIRECT (BEFORENOON) AND INDIRECT (AFTERNOON) GAIN. (B) RELATIVELY HIGH RADIATION AND (C) REMATIVELY LOW REDIATION AND TEMPERATURE VALUES: WELL INSULATED WALL AND DIRECT GAIN.

DIFFERENT BUILDING TYPES FOR LOCAL CLIMATES AND SPECIFICOIENTATION (A) BI-LATERAL WITH N-S AXIS, (B) BILATERAL WITH E-W AXIS; (C) UNI-LATERAL WITH E-W AXIS

## A TYPOLOGIC GRAMMAR

The correlation of building types and orientation can be seen in Le Corbusier's planned layout for 3 "Unite' d'Habitation" with a bilateral apartment block facing east-west and 2 unilateral blocks facing north-south. Further examples in the evolution of the unilateral apartment block can be traced in the works of other modern movement architects including L.Hilberseimer, H.Mayer, F.Marescotti e Figini-Pollini.

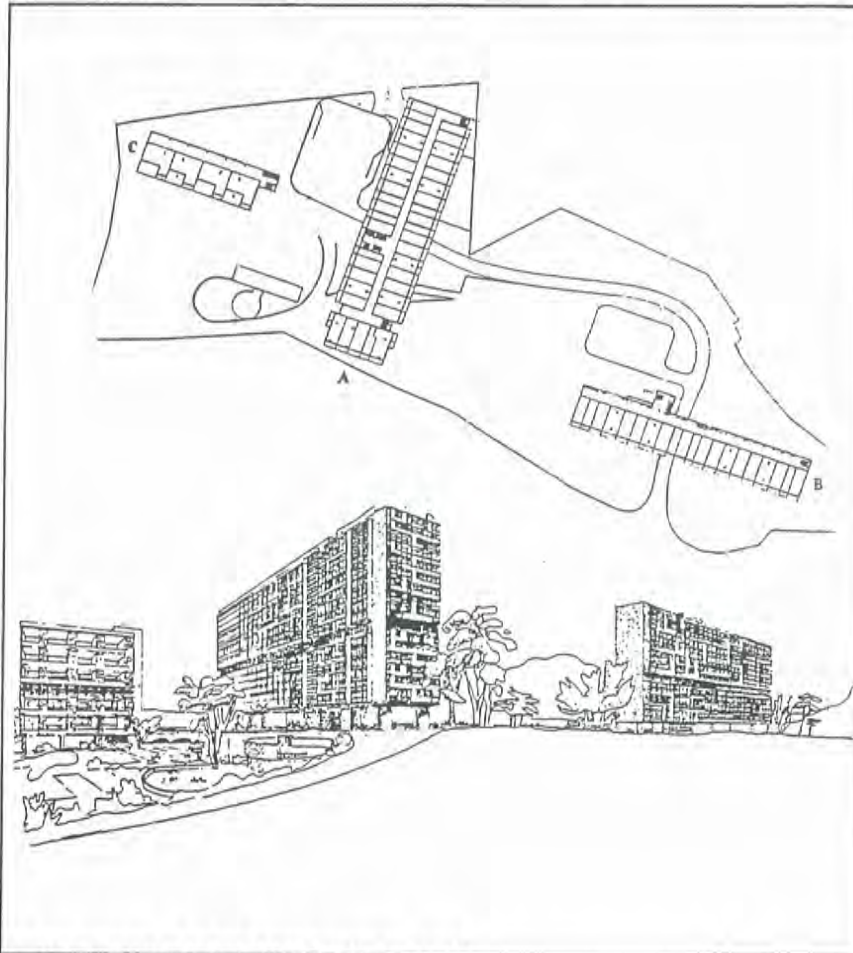

Le Corbusier, "Unite' d'Habitation", 1945

The Unilateral Apartment Block represents a rediscovery in bioclimatic architecture. Through many recent building projects presented, we can see how it is possible to design a wide range of variations, departing from this typological form.

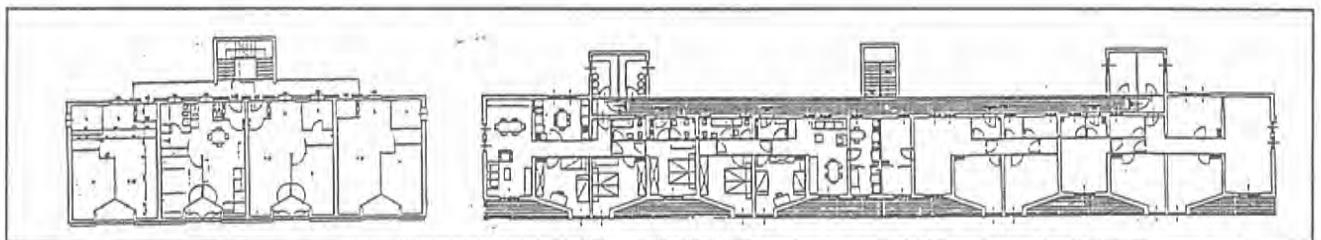

S.LOS, N. PULITZER : HOUSING PROJECTS FOR CASTELFRANCO, ITALY, 1981 AND BORGVALDITARO (PARMA), 1980

HOUSE WITHIN A HOUSE

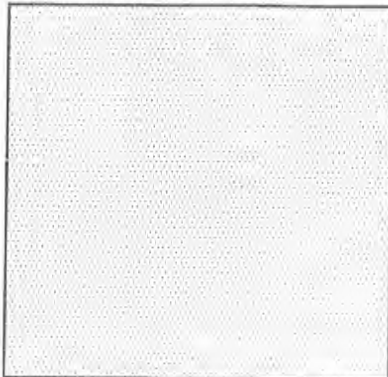

The primary form that characterizes the bioclimatic typology of the House within a House is the way in which it renders the interior living space somewhat independent from the outdoor climate. The dynamic thermal exchanges between the indoor and outdoor environment are regulated in this typology through an intermediate zone, mitigating the fluctuations of the interior climatic conditions due to the changing outdoor conditions. This "buffer zone" can take the form of a simple double envelope that allows only convective air circulation; a double envelope consisting of a passage way for user circulation; or a crown of rooms encircling a central room. This latter case is the basic bioclimatic form of the typology referred to here as the House within a House.

The concept of the House within a House can first be described analogously by the biological thermoregulation of the human body:

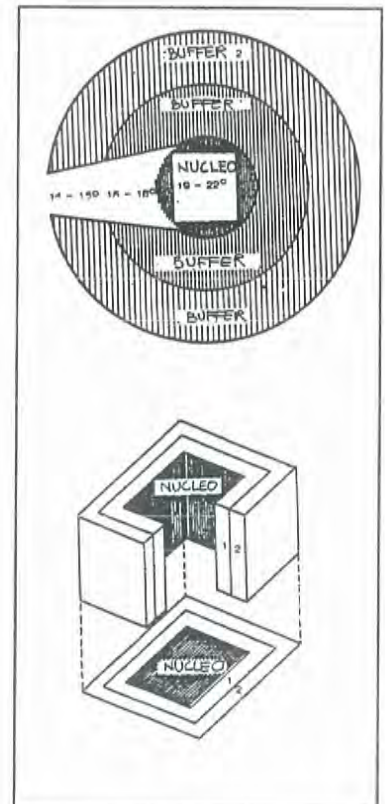
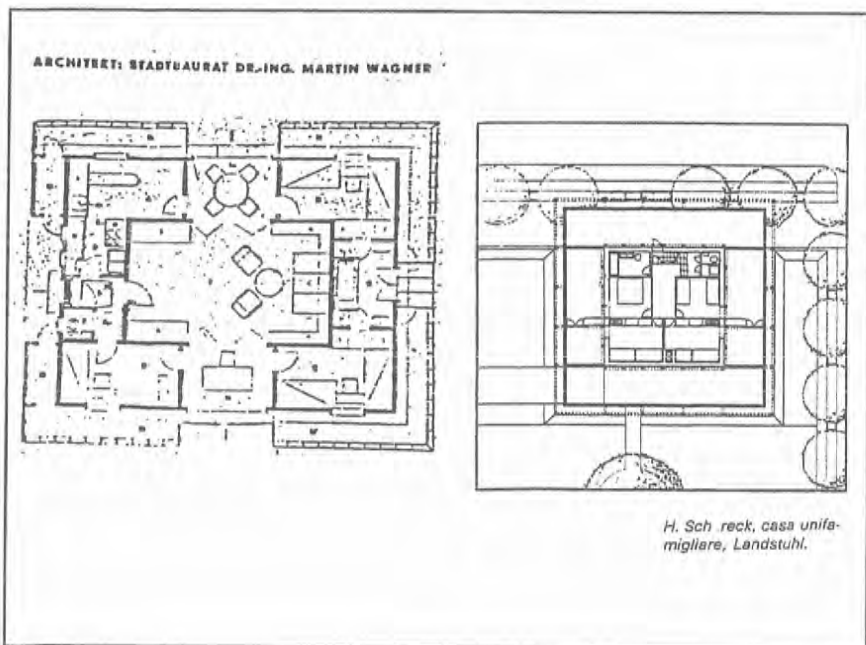
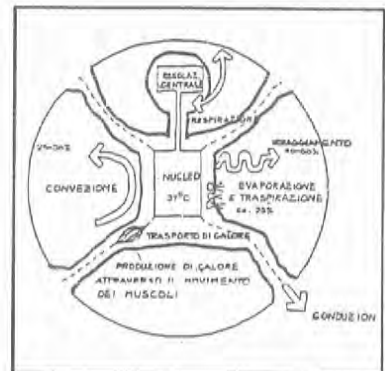
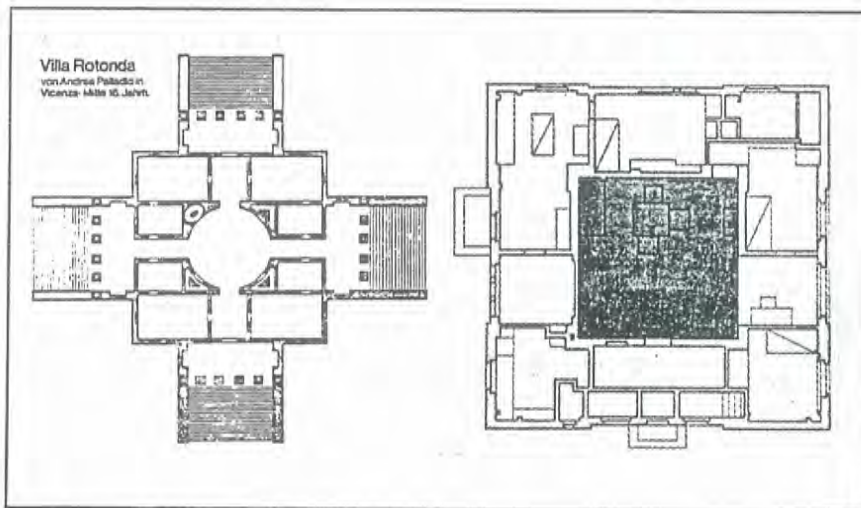

H. Schreck, casa unifamiliare, Landstuhl.



It can further be described illustratively by numerous architectural analogies as in the classic example of the Villa Rotonda by Andrea Palladio:

The most relevant aspect of this typology, however, is the climatic conditions of the internal spaces that are necessarily influenced by contact with the external environment. Different indoor activities and functions, requiring different levels of temperature and ventilation, can be correlated and assigned to the different climatic indoor environments distinguished by their adjacency to the external building skin.

This concept can also be interpreted and adapted to respond to the seasonal changes over the year, conceiving of the more compact and isolated core of the house as the wintertime living space which expands into the more dispersing perimeter zones for summertime use.

The variable parameters of the external environment creates variable conditions in the intermediate buffer zone as a function of the design strategies used to exploit or evade the sun and wind. This function is more explicitly expressed by the form of the triangular building typology. The concept of the buffer zone, on the other hand, is extended to the Glazed Courtyard Building Typology, in which case the intermediate zone is inverted to the central core of the building, usually in the form of a glazed court or atrium, that subsequently fulfills other energy and social functions.

The following designs and projects of concentric buildings layouts and envelopes exemplify the parameters that characterize this first typology of the House within a House, allowing us to extrapolate upon the concept to generate new bioclimatic building forms.

Having cited the Unilateral Apartment Block Typology as a proper bioclimatic building form that resolves the problems of building orientation posed by the Modern Movement in the 1930's, we must now address the problems related to aggregations of these building masses and the bioclimatic form of the urban tissue which they compose. An analysis of the historical urban systems and their relationship to the climatic environment and to the buildings that defined them, allows us to develop a proposal for a bioclimatic reconstruction of urban systems, its built private spaces and its open public spaces.

xxx

Traditionally, town layouts stressed the continuity of the streets and the town plazas, conditioning the alignment of buildings and their facades to the open space patterns. The open spaces (squares, streets, arcades, flights of steps) were designed as common spaces for the public to gather and meet. This urban form was especially prevalent in

GLAZED BUILDING      COURTYARD

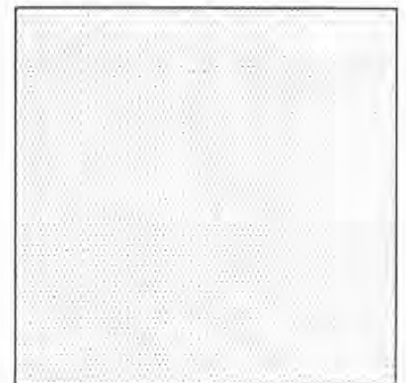



AERIAL VIEW OF SIENA SHOWING A RICH OPEN PUBLIC SPACE NETWORK, TYPICAL OF TRADITIONAL TOWNS IN TEMPERATE CLIMATIC REGIONS.

temperate and hot-arid climatic regions and an integral part of their cultures.

The rationalist theories that permeated the modern movement instead, brought a destruction of public open spaces by emphasizing the importance of the building volume and conceiving the urban tissue simply as a juxtaposition of many buildings. This concept is expressed by the parallel building slabs described previously, oriented along the defined heliothermic, north-south axis, merely leaving the voids between the buildings to serve as public open space and roadways.

After World War II, the interest in urban public spaces as an element for social interactions became a renewed foundation for urban design, while the problem of orientation was neglected because of the availability of cheap and abundant energy. The repression of the problems posed by the climatic environment affected not only the energy consumption of the buildings that delineated the open spaces, but also the quality of the outdoor spaces themselves.

The problem architects and planners face today is to consider both social and climatic factors at the urban scale through bioclimatic concepts and practices, remaining conscious of the building orientation demands.

The counter-position of the orientation base of the existing public space network to that of a new bioclimatic strategy, cannot be reconciled, obviously, by a simple 90 degree rotation of the principal urban access, as urban and building orientation demands for solar access are often in conflict.

Glazed courtyards and atriums, central to a building or a complex of buildings, liberate the building system from orientation constraints, collecting the sun's radiation from above. The urban tissue can therefore be structured in any direction, yielding priority to solar access of open space. Glazed streets and plazas, moreover, become additional public spaces as transitional zones between the internal and external environments, particularly applicable in colder climates.

The concept of the glazed courtyard is epitomized by proposals of Ralph Erskine and Buckminster Fuller to create entirely covered urban centers.

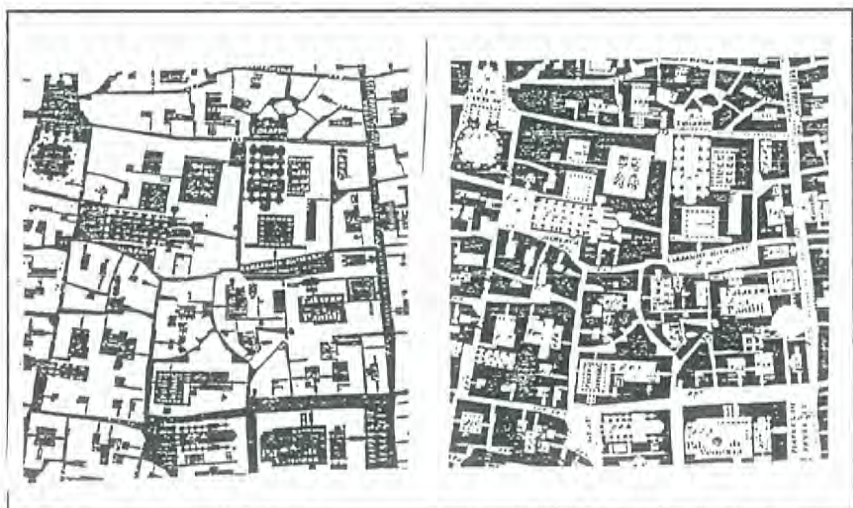

## A TYPOLOGIC GRAMMAR

At a building scale, the glazed courtyard functions as a private sheltered space and as a buffer to dampen thermal extremes within the living space of residential buildings.

Larger scale atriums, commonly used today in commercial buildings, function similarly as an unconditioned buffer space to reduce the building's thermal loads, while increasing the aperture for natural daylighting and lending the possibility to vary the compactness of the overall building form by seasonally regulating the glazed covering. The greatest amenity of the commercial scale atrium though is the central space that it provides for public gathering and circulation.

The following collection of examples propose, at large and small scales, various examples of the Glazed Courtyard Building Typology.

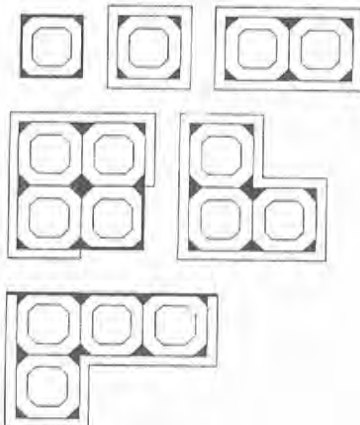
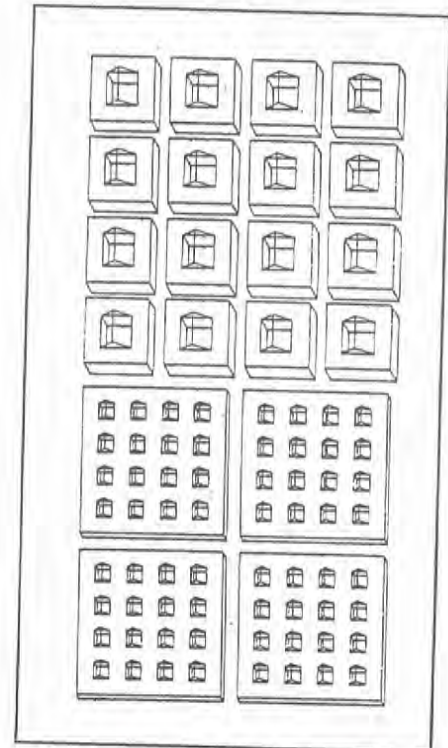
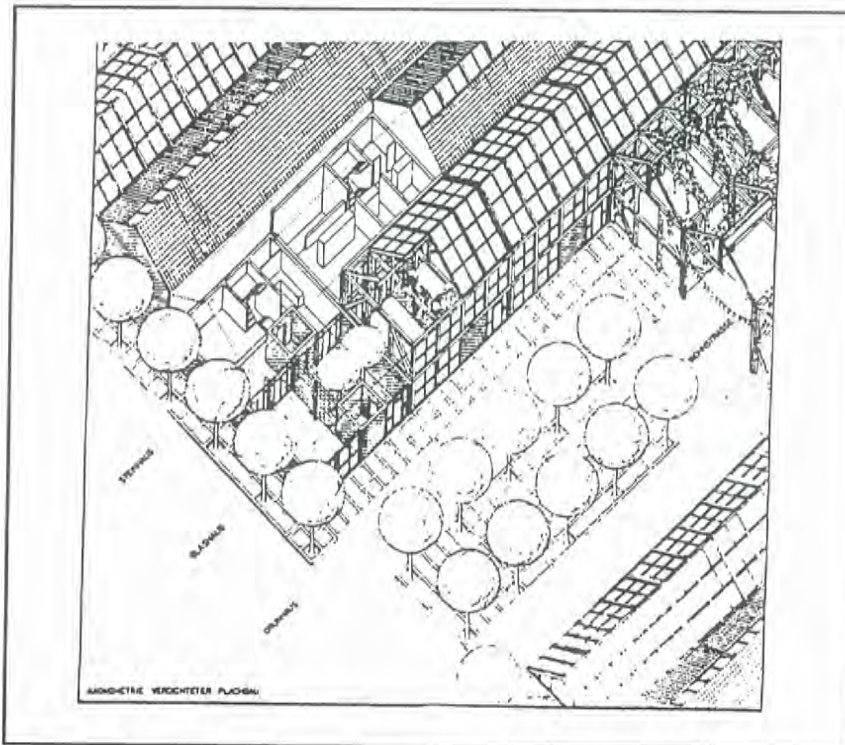

b. Many combinations are possible to fit sites and functions

01 A concept for daylight building form by Dean Hawkes and Richard MacCormac. Using models the authors developed a module of space able to be naturally lit to office background illumination levels for the months of April to September in the UK, the court form thus eliminates summer cooling loads and collects and conserves winter heat

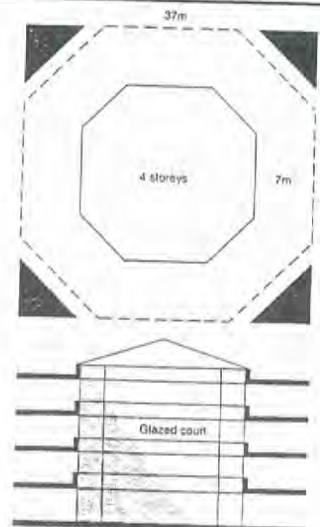

a. The generic form

1.6.4 SHELTER GROUP  
MODULES, THE WALLS  
(FACADES)



A . KLEIN, 1950, STUDIES ON THE INFLUENCE OF CLIMATE IN THE FACADE DESIGN; THE CITIES ARE HAIFA, TEL-AVIV BERLINO , OSLO

The contribution of the bioclimatic culture to architecture has been analyzed in the previous section, describing four plan layout modules that form the types of triangle building, unilateral apartment block, house within a house, and glazed courtyard building. Now the same contribution will be defined for the elevations.

Within the modern movement, building elevations were completely determined by the plan layout (le plan generateur); they had no autonomy in the design activity. The post-modern culture strongly enhanced the relevance of the facade by recognizing the contextuality of architecture and its urban dimension, and stressing the facade's role to define the urban space as a room without ceiling. The bioclimatic culture gives a scientific basis to this new significance of the elevations, but at the same time focuses the regionalist character expressed by them, emphasizing more and more the relationships between the building and its site.

Seven issues are relevant in a study of the walls modules:

- 1 ● The ratio between the opaque portion of the wall and its apertures. Ranging from the massive masonry culture to the wood grid culture, bioclimatic design recognized the climatic reasons of such differences and referred them to specific climatic regions.
- 2 ● The variability of apertures related to different positions in the same facade, from ground floor to the intermediate floors up to the attic floor, defines three well recognizable horizontal areas.

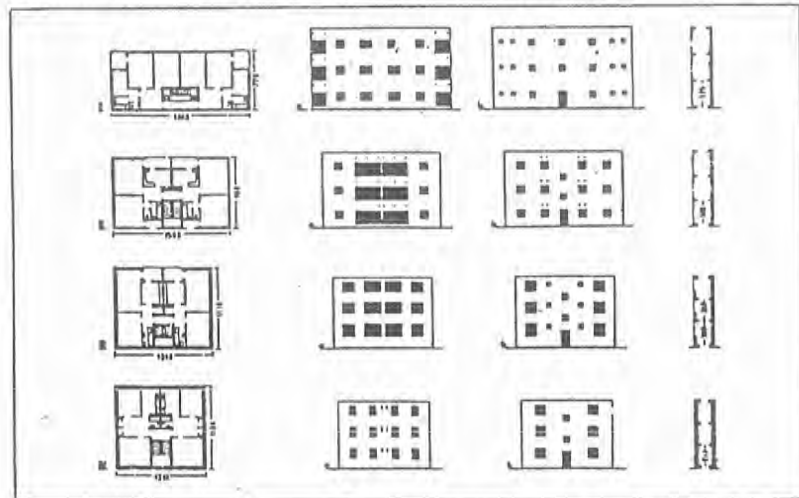

- 3 ● Vertical differentiation, which characterizes the corner and the internal facade portions.
- 4 ● The facade often acquires a depth, inside or outside its wall plane, to open balconies or more complex window components.
- 5 ● This wall depth becomes a twofold facade characterizing its belonging to the street and to the building, with one side connected with the urban public outdoor space and the other connected to the building private indoor space.
- 6 ● The building itself shows its anisotropy distinguishing a public facade and a private rear, considering pertinent the social dimension of the construction, and its organizational, distributive characteristics.

The examples presented in the following pages make evident, in the language of architecture drawings, the relevant features of these facades.

1.6.5 SHELTER GROUP  
MODULES, THE ROOFS

(i tetti del passivo)

1.6.6 COMPOSITION OF THE ROOM

## A TYPOLOGIC GRAMMAR

7. The environmental dimension of construction, focused by the bioclimatic design experiences, distinguishes a south from a north elevation (a west and east elevation), adding to the composition culture the environmental characteristics of architecture.

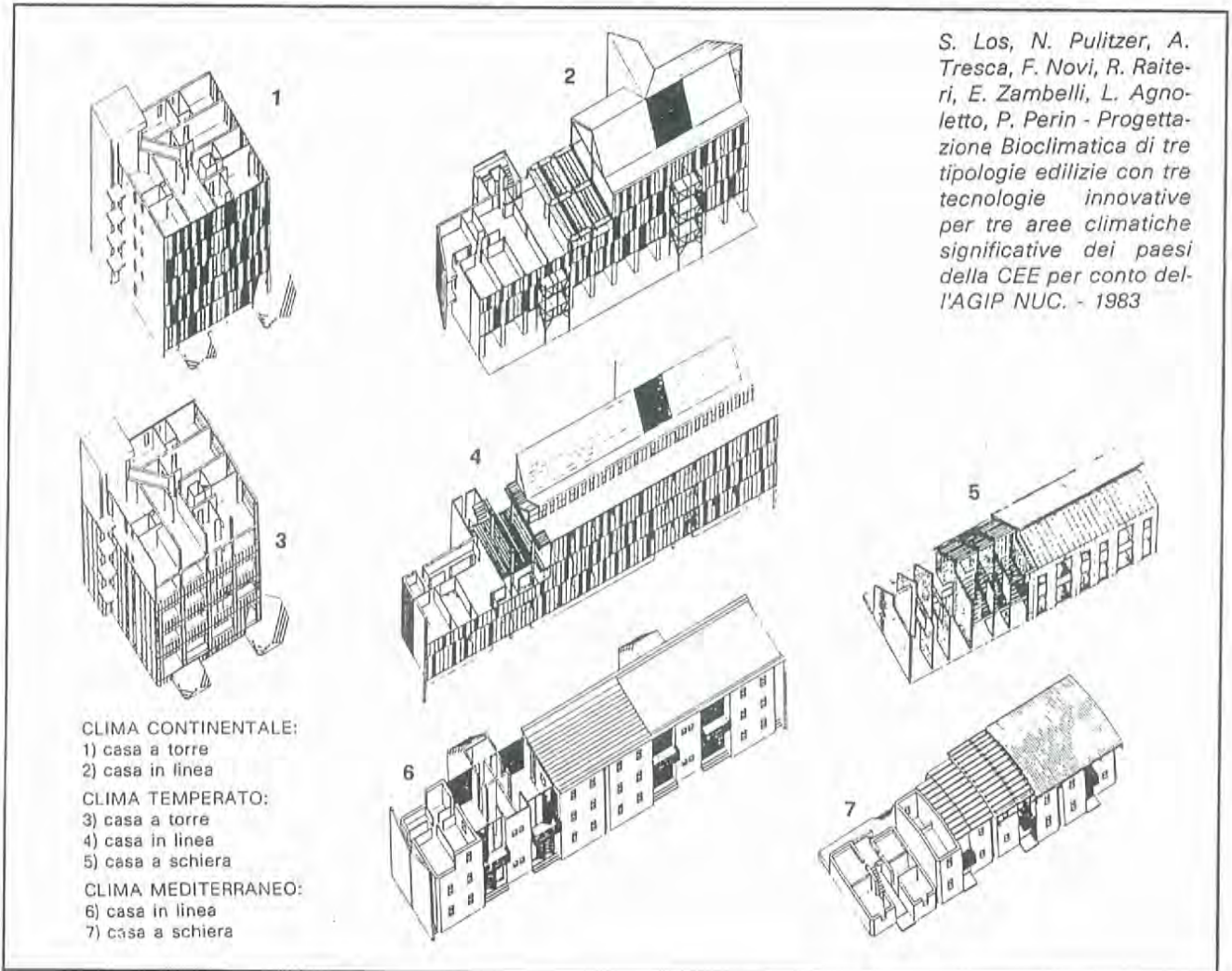

Considering the environmental performances, the bioclimatic codification of architecture developed four facade modules:

- 1 ● the north elevation where the apertures are smaller than possible, keeping in mind the daylighting requirements;
- 2 ● the south aperture-wall (the direct gain system) that enlarges the solar windows to improve the solar energy collection;
- 3 ● the south collector-wall (the indirect gain system) that can collect the solar energy without opening the whole facade;
- 4 ● the south room-wall (the isolated gain system) that uses the buffer space within the wall to regulate the energy flow between inside and outside.

## A TYPOLOGIC GRAMMAR

It is possible to characterize the heating interaction of a passive solar regulating envelope between a heated subject/room and an outside heating solar space. The architectural statement can now be subdivided into two groups: the heated site (the served space) and the heating regulation system, including the envelope and its surrounding spaces (the servant space). The regulation system can now be subdivided in the subsystems defined by homogeneous interactions (the variously oriented planes) between the site and the adjacent spaces, walls (distinct by facades, rear, sides) and roof. Every subsystem is subdivided in the pierced wall as the heating component (the window in the wall) and the space outside, which can be another heated room, or a street or the sky dome of an unobstructed place.

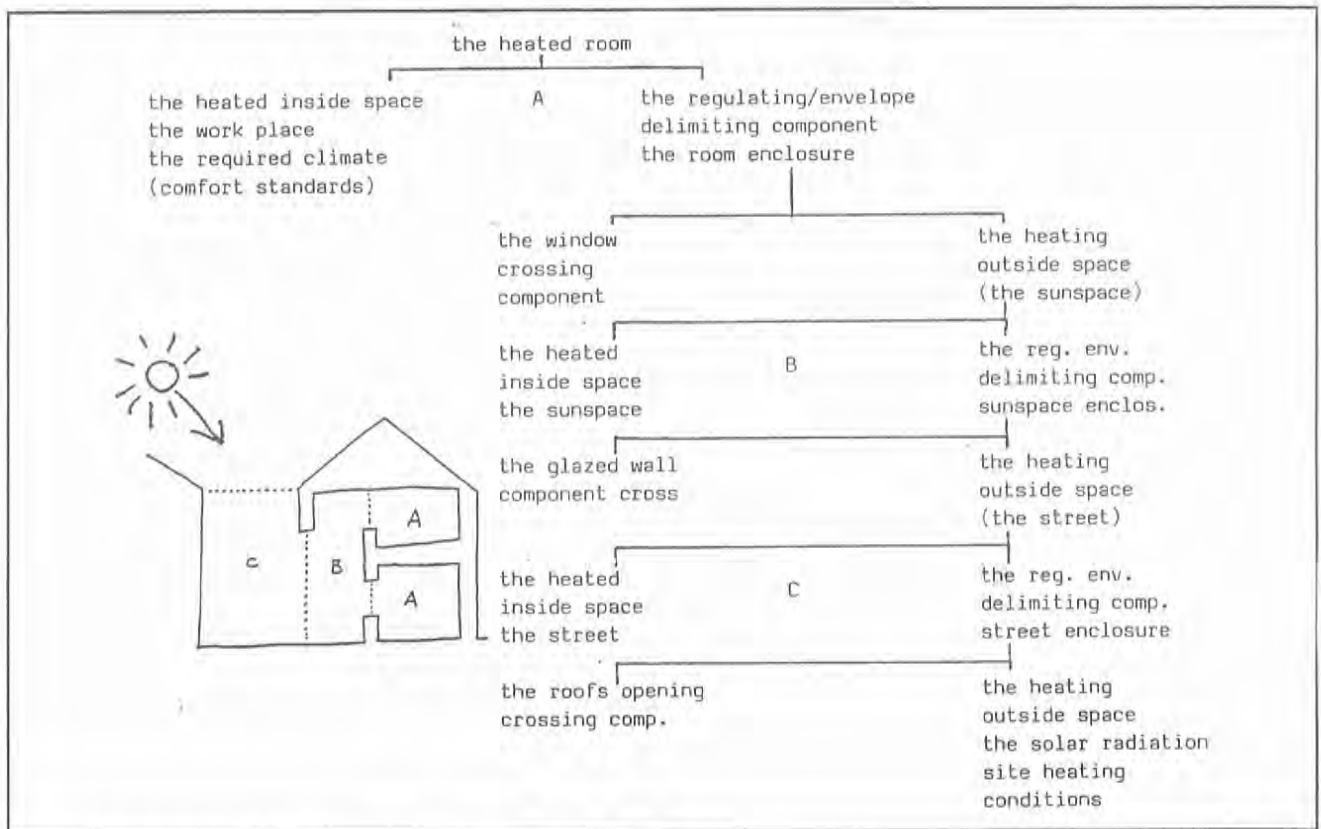

A designer is always involved in inventing/selecting the satisfactory solution of a problem. For an architect, the general form of this solution is a room. We consider the room a type or an instrument that couples a tool and an operation. In defining the comfort problem, we consider as pertinent features of operation the heating or cooling (space conditioning) performances required and the satisfactory shape of the tool providing for them. The operation is defined in terms of comfort conditions or of the required performances. Then the architect searches in the repertoire the type that could supply such performances, running the issues of this repertoire which contains the couples of shapes and performances admitted by the operant codes.

These couples, or types or instruments, are arranged at the above mentioned four typological levels.

We call the types of the repertoire terminal types. The architect has to select and place them following the base rules of the grammar. This selection and placing follows semiotic judgments (or evaluations) and is driven by the syntactic structure. Adaptations of these types can follow the composition of planes to fit them to individual programs. These adaptations are performed through parametric and combinatorial transformations, which are tested by semiotic judgments. In special cases, these transformations are tested through computer models simulating the climatic system behaviour.

The major contribution of research on energy saving and passive solar design during the past 10 years should be used to update the operant codes in order to support the current semiotic judgments of design activity. Many experiences can confirm this approach. A survey for EEC shows that architects, when receiving recommendations from a consultant that influence their designed shape, will not use them in the current project, but will wait until the next project. ( )



An architect, when designing a building, starts with a set of requirements concerning the users activities, the building place and the available resources/technologies. The data describing these requirements are organized in a Design Program dealing with the definition of the design problem.

After this program elaboration, the architect is facing his own problem and to solve it he considers the PRECEDENTS of the possible solutions in order to generate the design hypotheses. In this work he is helped by the typological studies (contained in the treatises and handbooks, in the past, and mostly in the recent magazines) showing the precedents classified and grouped together. The presentation is not systematic because the functionalism of modern architecture denied any imitation, considering it shameful and useless. For this reason, it is quite impossible to teach architecture in schools, and so to transfer research on energy conservation to architects.

Books and magazines publish numerous projects without thinking that they are acting as treatises. No system of notation is mastered and made conventional in order to map these projects for a theoretic purpose.

Architectural composition includes three main operations: selecting, placing and transforming the types (or precedents).

Hence, the architect has to SELECT correctly the types, having in mind the requirements collected from his clients; after the choice, he should PLACE these types in his project, combining together: plan layouts, elevations, sections, etc. Now, having composed the types for his design solution, he makes some adaptations, modifying them through PARAMETRIC TRANSFORMATIONS and COMBINATORIAL TRANSFORMATIONS.

The selection and placing of types follow BASE RULES, relating to pattern recognition and a place identification, while their modification follows the TRANSFORMATION RULES, concerning a parametric and/or combinatorial variation of the selected and placed types.



## 1 INTRODUCTION

We prepared, for a specific regional architectural language, some repertoires using the design experiences of the past years in the field of bioclimatic architecture. We also defined the rules which help designers make the correct choice of types and in placing them to compose rooms at different architectural scales. Other rules fit these rooms to the individual characteristics of sites and institutions, modifying the planes of types following the performances that the operant codes couple with them.

These repertoires have been mostly used for multifamily houses in urban projects where the multiscale architecture system is better recognizable, but they could be used also for other building types.

Developing the competence to use this grammar, one should understand and recognize the differences of climatic sites, "reading" correctly the architectural features of rooms and buildings. With this language in mind, any architect should be oriented to use those types which save the non-renewable energy sources, improving the environmental qualities of our architecture.

Rather than producing design tools that architects will never use, we are involved in updating the existing codes of architectural language, presenting good examples and developing logical analysis of currently published buildings, in order to increase the awareness of environmental characteristics among architects.

The Tables show the study of elevations, placed in the south and north side of an east-west square, and the developed plan layouts for multifamily apartment blocks. The example presented is a project for the rehabilitation of an estate in the city of Bolzano, in Northern Italy. It applies many bioclimatic principles in a regionalist way that accounts for the cultural identity of local architecture. Parametric analyses were conducted to size correctly the apertures in south and north elevations taking into account the biolighting and bioclimatization of buildings. We expect that the availability of formal models, made systematic by the organization of the grammar, will be more efficient than the scientific and bureaucratic authority of standard prescriptions.

## 1.2 COMPUTER ASSISTED GRAMMAR

The theory is, of course, quite independent from the tools used in design activities. They could be the traditional ones, but we think that the introduction of computer assisted design and drafting should improve the practice of the architectural grammar. The possibility of preparing a repertoire arranged as a data base and of collecting the rules in the form of an expert system, should allow for a cumulative, self-learning, work in progress through a continual evolution of the knowledge base

that integrates the various experiences of different designers and builders.

The software we are using as a two-dimensional editor (Autocad 9.01) is a very well equipped program. Its Autolisp facility is a real programming tool, whose flexibility, when joined with the interactive operators supplied by Autocad, allows for many different but specific graphic elaborations.

A whole set of previously defined procedures and tools have been implemented through these software facilities, including the following modules:

- 1 - operators to support the construction and updating the repertoires;
- 2 - operators to select the types, as the required performances have been defined, within the repertoire by choosing within catalogues placed on the tablet in the shape of menus;
- 3 - operators to transform the types within particular, geometric situations;
- 4 - operators to transfer the type shapes from the repertoire where they are selected to the polyhedron where they are placed.

The menu is a particular kind of subprogram, modifiable by the user, which the designer interacts with by the use of a tablet where a keyboard is mapped on a paper sheet. Selecting and pressing a rectangle of the digitizer template, the instructions coupled with such rectangle are activated. These instructions include sets of base-instructions and shapes that are recalled from the archive.

A repertoire is an ordered collection of building types in the shape of plan layouts, elevations, sections, roof-plan, etc. Every type couples a shape and the related performances, and the types are subdivided in various typological levels. The repertoire hence is a catalogue of typological models, arranged in order to make the selection of the types as easy as possible to the designers.

The issues collected in the repertoire embody and communicate the knowledge of the shapes and of their performances. We consider the modifications of the shape and the related modifications of the performances to define the range of shape transformations implying such small performance transformations (consequences) that they can be disregarded, and the group of such shape variants can be thought of as equivalent. The level of sensitivity which defines the performance transformations within which the related shape transformations are allowed represents a critical parameter of the grammar. The semiotic judgments are value judgments which evaluate not only the specific performances but also their relative weight.

## 2 THE REPERTOIRES, THEIR ORGANIZATION AND MANAGEMENT

A type is defined to act as a pattern-sample for all the shapes whose transformations can be considered as providing for equivalent performances, within the defined sensitivity level. This type becomes a key shape which synthesizes all the allowed shape variations within equivalent performances.

Every type is described in the repertoire by three items:

- the shape, mapped in a drawing that defines its geometric characteristics (the plan layout of a dwelling, the elevation of an office building, the roof of a museum, etc.);
- the problem of which the shape represents a solution, the pertinent consequences expected by the construction of such shape, the various performances it provides for (constructive, organizational, formal and, most important for our purpose, environmental) and the position within the reference system;
- the context within which the shape, with its variants, can be applied to solve the problem, presented as a rule which defines the range of geometric variability with equivalent performances, and referred as a "sited type" to a specific cultural and climatic place.

### 2.1 THE REPERTOIRE ISSUES

The definition of the repertoire must cope with two main problems:

- the format, its layout, the tools for updating it, the information included;
- the shape, the structure of its representations, the architecture system of notation.

The repertoire collects shapes which include plan layouts, elevations, facades, roofs, etc. These are "signs" whose combination forms types. Only the types, which are the various level rooms, can provide for particular performances. A roof, a facade, a plan layout, etc., without constituting a room through specific spatial relations, cannot supply the dwelling performances. The idea that a sign too has a performance derives from the habit of using it nearly always in the same combination to form a room, so the sign presupposes the type within which it is often included.

We assume a defined range of modifications within which, regarding dimensional shape limits and ratios, the related performances could substantially change.

Within such modification range we individuate a "stereotype" whose consequences could be shared by all the shapes of the same variations group, that stereotype becomes the key-shape within the repertoire.

NORTH SIDE STREET  
BILATERAL APARTMENT



SHAPE

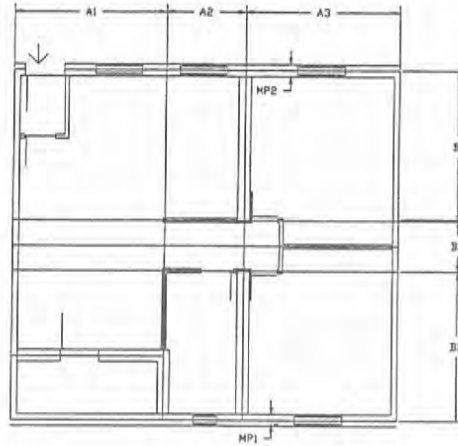

PERFORMANCES

TRANSFORMATION RULES

$A1 \leq 5.00 \text{ mt.}$	$A1 > 2.00$	$(A1 * B1) > 8 \text{ mq.}$
$A2 < 4 \text{ mt.}$	$A2 \geq 1.5 \text{ mt.}$	$(A3 * B1) > 12 \text{ mq.}$
$A3 < 5.50 \text{ mt}$	$A3 \geq 2.50 \text{ mt.}$	$(A2 * B1) > 5 \text{ mq.}$
$B1 \geq 2.50 \text{ mt.}$	$B1 \leq 5.00 \text{ mq.}$	
$B2 < 2.00 \text{ mt.}$	$B2 > 1.3 \text{ mt.}$	

$(A1+A2+A3)*(B1*B2*B3)-(TP*A1) < 75 \text{ mq.}$   
 $(A3*(B1+B2+B3)) < (0.4 * Stot)$

## 2.2 STRUCTURING THE SHAPETHROUGH BLOCKS AND LAYERS

Almost all the graphic editors now provide the designers with the possibility of using some overlapping virtual transparent layers, on every one of which one can arrange various design information as the main walls structures, geometric axes, modular grids, etc.

Such layers can be combined, overlapping some selected ones, in order to get various cross "readings" of different design layers.

Many different subsystems can occupy the same space, but the overlapping of shapes becomes a noise which makes their pattern recognition very difficult. The use of layers in the repertoire allows for matching the readability of shapes and the increasing complexity of overlapping subsystems.

There could be a stage in which we maintain the only visibility of modular grids, and another in which we need to match the structural grid and the installations layout, etc.

This opportunity can be used in the repertoire appointing sets of layers to various tasks, whose names are encoded as shown in the following table.

The alphanumeric coding of each layer can be coupled with a number that refers to other layers of the same category, for example, to another geometric layout layer.

These different sets of information maintain their consistency within the same shape, to which we might also associate non-geometric information. In that way the shape can later be extracted, placed, duplicated and deformed, preserving its recognizability.

Another way to organize the design information contained in the drawings consists in grouping sets of graphic entities, belonging to different layers, in order to form blocks. All the block entities can subsequently be handled together. The possibility of grouping blocks to constitute higher order blocks, gives to this organization a hierarchic structure, that looks very important for collecting the architecture types in the repertoire. Also, non-geometric information can be associated to such blocks at various levels, it must be defined through another alphanumeric coding.

Blocks allow:

- to define a hierarchic organization of the shape;
- to use the same shape many times.

It is possible to operate, following some composition rules, only at one level without influencing the other ones.

Geometry systems group

**GE** geometric layouts (axes, alignments)  
**MG** modular grids

Structure and envelope group

**MW** main walls  
**IS** internal structures

Aperture group

**WIN** windows  
**DOR** doors

Furniture group

**FUR** furniture  
**SAN** sanitari

Texts and dimensions group

**DIM** dimensioning  
**TXT** texts, attributes  
**FORMAT** page frames and tables

Figures, with their associated limits of variability are defined in the repertoire. In order to provide a grammatical definition of the transformations, the various types of transformation permitted for a figure must be clearly defined.

A group of transformations is not characteristic of a figure, but of a class, in the same way that the same transformation may be applied to various phrases so there is no specific transformation for a particular phrase.

A figure may be described by means of graphic segns. Performance is described in terms of a figure. In this case of architectural projects they are often determined through the application of specific algorithms, of quantitative data.

The application of an algorithm may be considered a translation into non-geometric terms. This translated data constitutes types of information comparable of a code associated with the figure.

2) the code is intended to be a key to the arrangement and research of the figure. Our hypothesis is that the performance coupled to it, and therefore information which describes the performance of a figure must be integrated into the code.

Such performances describe both general and specific characteristics of the figure-entity are so follows:

- the space within which the entity is inserted
- the space into which it is put.
- which part of the shell it is (what type of filtration it represents)

2.3 THE SHAPE AND PERFORMANCE CODE, VARIATIONS OF THE SHAPE WITH EQUIVALENT PERFORMANCES

# THE REGIONALIST DESIGN LANGUAGE METHOD

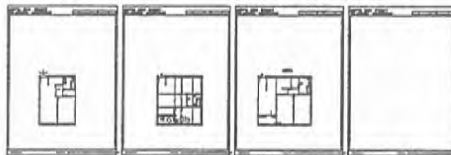
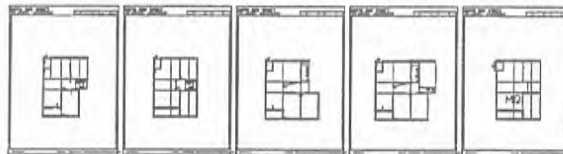

SOUTH FACING FACADES

fileFILE

produced PRODUCED last edit LAST\_EDIT



# THE TYPOLOGIC GRAMMAR FOR NORTH ITALY

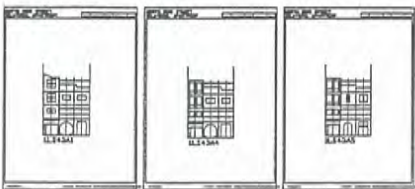
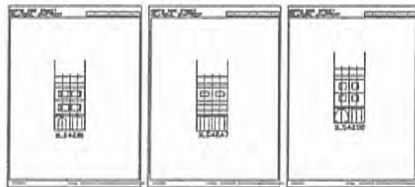
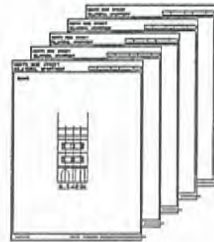

SOUTH FACING FACADES

fileFILE

produced PRODUCED last edit LAST\_EDIT

## Specific characteristics:

- the number of floors used,
- the number of modules
- the depth or area of a room (figure representing CODE)

Some of the specific characteristics are not applicable for certain types eg. the area for prospects. The choice is made in this case to maintain a single code which is compatible with any type of description. Within this code there will eventually be certain parts left unused.

There will be a single general code for the whole of each page of the catalogue where more types with characteristics of homogeneous performances are collected. All these types go well with prospects oriented towards the south which close a building in line. There will be various specific codes for each of the represented figures.

## VARIATIONS RANGE OF THE SHAPE

Every figure can undergo a series of transformations within determined limits, without the performance being modified.

Therefore, for example, if one defines the objective that a residence should have 75 mq of surfaces and room for four beds, one must try to produce a residence in which the surfaces are approximately 75 mq, where the "approximately" is clearly conditioned by formative use and indications. It may be the case that a value must absolutely not be exceeded, but it may also be possible to allow a difference of 1-2 mq. Nonetheless every figure possesses a certain degree of possible modification

The limits insure that the operations of transformations remain within limits which guarantee that the performances remain constant, but it is nevertheless possible to alter the figure outside of these limits. In such a case the system should inform the designer that for that particular figure the range of associated performances is no longer reliable. The responsibility of checking this falls upon the designer.

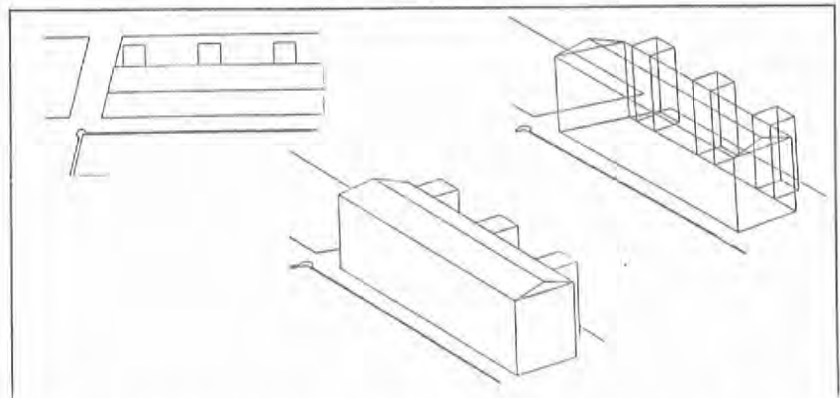

In the preliminary defining of the project, the program starts.

Within this program there is a defined series of specifications, partly figurative, but mainly on the shell, both through the definition of the shape and direction of the shell, and through the definition of the quantity to be produced. The performances defined here become more or less the key to research into the figures of the repertoire.

The composition rules include three main design operators:

- the selection of appropriate types
- the type placing
- some combinatorial and/or parametric transformation to fit the type selected to the design program

COMPOSITION RULES  
SELECTING, PLACING  
AND FORMING THE  
ARCHITECTURAL  
TYPES

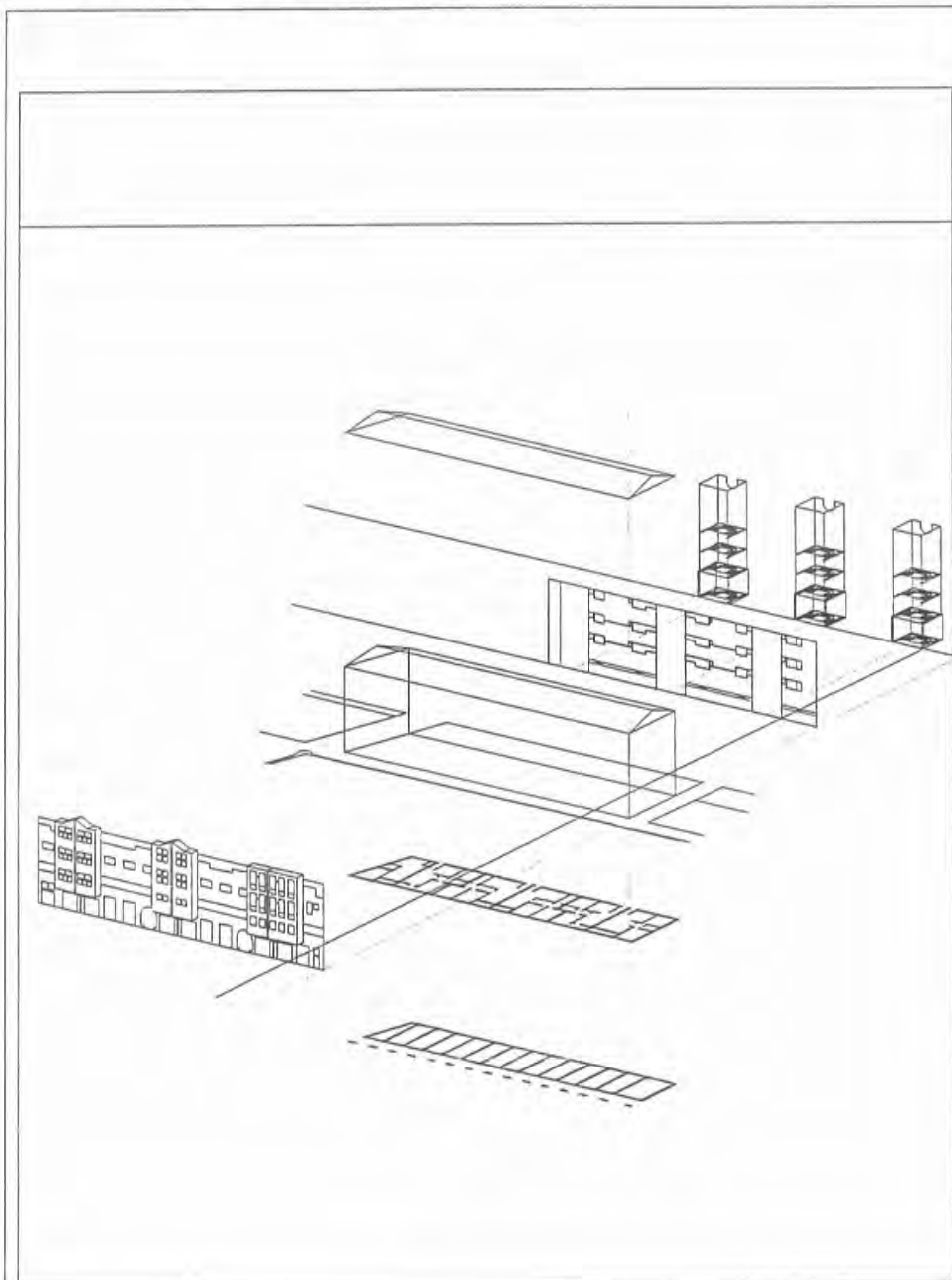

THE SELECTION  
OPERATOR

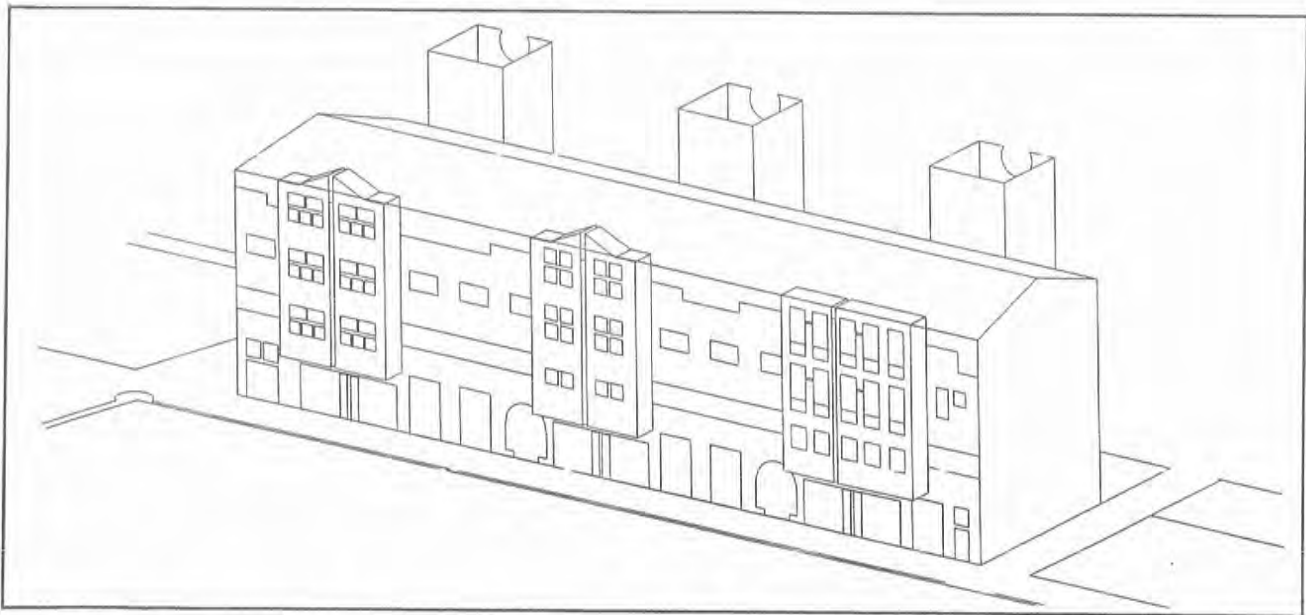
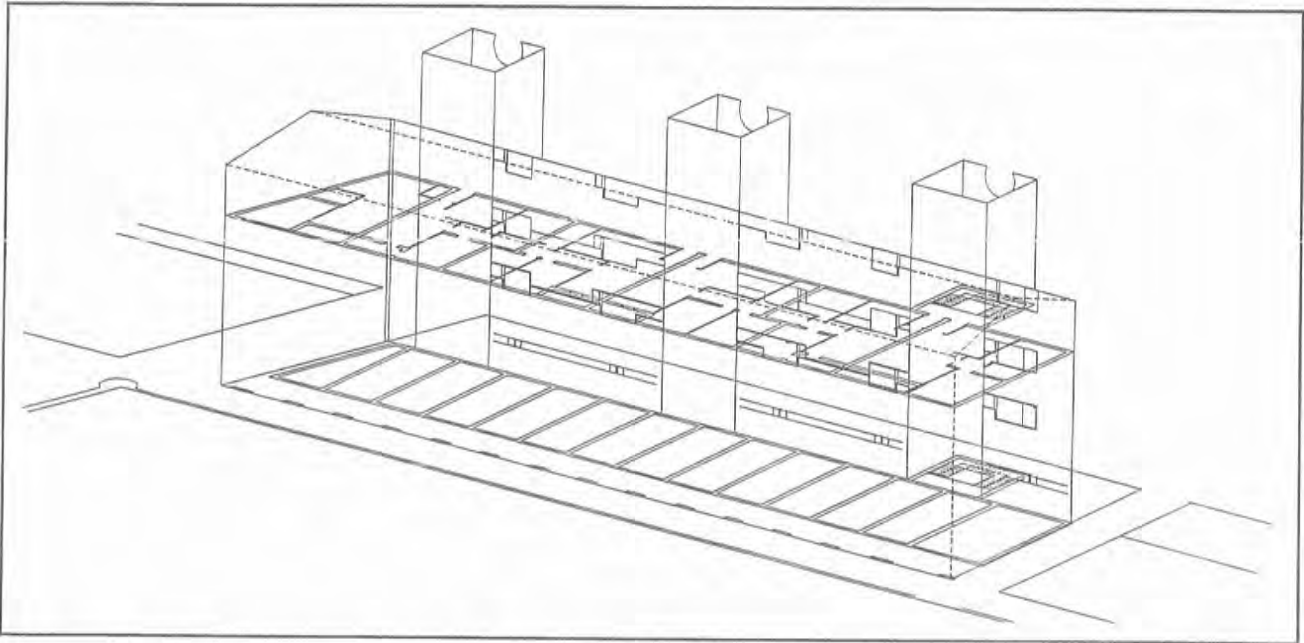

## THE SELECTION OPERATOR

The operation of SELECTION consists of reconstructing code, and then searching inside the file which contains the repertoire of figures whose code identifies with that requested.

At the conclusion of the operation a group of types may be arranged which constitute possible alternative solutions to the request formulated using the code.

The operation of SELECTION consists of two phases. The first regards the reconstruction of the performance requested by the program in the form of a code, or its refining in successive phases. The second regards the search inside the repertoire of figures for the code which identifies with or is closest to that specified by the request.

The context of this operation depends on the face of the shell on which we are working. The figure (com-psi p.2) is an example of a prospect facing south onto a public area. We have extracted the profile of the south face from the three-dimensional general shell. Modular partitions have been traced by the perimeter on the so-defined quadrilateral. For this first series of generations we have used types with prospect widths of two or three modules.

#### THE PLACING OF THE PARTS WHICH FORM THE 3-D BUILDING

- Reference grid system
- allows operations in the 2 directions
- extraction and projection on a storey of the face to be composed
- placing of the composed surface in its correct position

The 3-d controls of the final assembly.

Using modules and lines of geometric construction, the single types extracted from the repertoire can be placed with precision while still maintaining a wide enough frame to allow overall vision (a final note on the problem of the solution of using video in respect to legibility of detail).

The same geometric alignments serve to carry out successive movements, to produce various types of copies, mirror-like symmetries and repetitions of groups of figures. During such operations one always proceeds by manipulating entities which maintain their internal structure intact. The types which form the repertoire of prospects are filed away identifying the formal type with a "slice" whose width corresponds to a certain category of residence size present in another area of the repertoire. The height of the type remains intact because, as we have seen, any ulterior sub-division of the base, central zone or top of the figure would have caused an excessively fragmented resultant image and therefore also its legibility as a figure.

The exploration of variants becomes considerably easier because of this working in groups. It is clear how the generation procedure of the combinations can away from the casual choice within the selected group to a systematic variation of a single element. ( In the examples in the figure the various combinations were generated by progressive substitutions right from the first hypotheses).

The elements presented in the repertoire must be constructed in such a way that every legitimate combination guarantees the correct resultant group.

They should, for example, have roof profiles and homogeneous trademarks for storeys and window-sills.

Once they are defined in geometric terms they are related to the meaning of the spaces which they represent. In such a way accuracy checks can be carried out and the exact dimensions of

#### COMBINATIONAL TRANSFORMATIONS

COMPOSIZIONE DI PIANTE



TEMA COMPOSITIVO

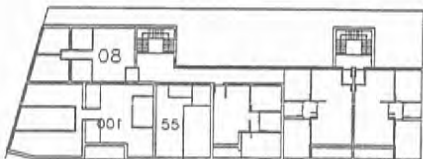
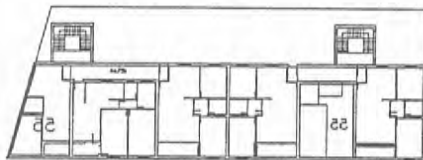
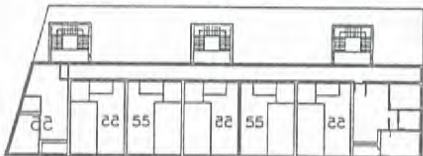
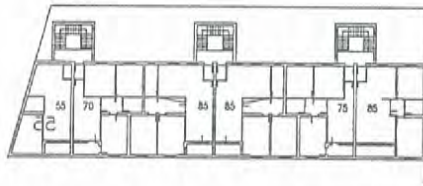

COMBINAZIONI DI PROSPETTI SUD SU SPAZIO PUBBLICO  
VARIAZIONI SU EDIFICIO IN LINEA



TEMA COMPOSITIVO

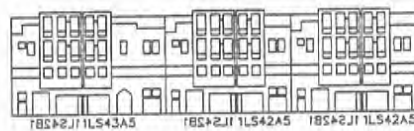
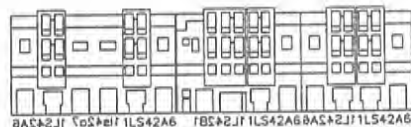
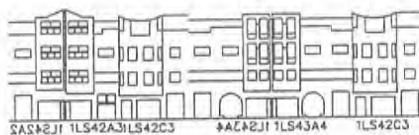

each room can be given, related to the destined use of said rooms.

### PARAMETRIC TRANSFORMATIONS

When the type selected from the repertoire doesn't completely solve the problem posed by the context, the next step is to transform the type itself. We have already had the opportunity to define the types of effects of the transformation of the figure. These may or may not affect a variation of the type performance. These limits are described in the rules associated with the figure in the repertoire. The reference figure, like all the figures in the repertoire is described in the form of non-schematic designs. Performance may be calculated from this figure. Let us hypothesise the surfaces and distribution in this case.

#### GLOBAL TRANSFORMATION OF PLACING

We have joined a first type of transformation to the DISPOSITION (fig.).

What follows is a matter of steps applied to the group of the figure according to the main directions of its geometric structure. The deformation takes place independently according to each of the two more geometric directions.

### LOCAL TRANSFORMATIONS

The following type of transformation considers an extension of the procedure. Other than these steps applied to the groups or group of transformation operations becomes available. They share a common characteristic, that of operating on a local ambit, that is, a specific part of the figure, affecting the other parts of the figure itself only partially, or not at all. Also, in this case, the type of transformation can sway from the transfers or local rotations to the convergence of a series of parallels. It then becomes a matter of initially defining a network of binds for the group to limit the type of transformations and then to define just exactly what is permitted and within what limits for each figure. The types of transformation can be characterised in two into specific categories for cultural and temporal ambits.

In order to define exactly what a transformation acts on, it is necessary to define what remains constant. We have already said that in our case the performance remains constant. In the description of a figure just what are the performances that remain constant must be made explicit, after which we can define how to make them remain constant by means of the definition of rules which must be as well- described as the permitted margins of variation are wide. The variations act on a field within which the entities present react in various ways. [Ref. from the internal and external relationships towards the object of architecture.]

A project is the fruit of the relationship between an internal and external construction. The group of relationships and the



context define the degree of structurization of the external opposed to that of the internal.

A renaissance building in the Palladian style has an elevated degree of internal structure, A gothic residence has a higher degree of external structure. We can extend this concept thinking of the building as a group of parts placed within a field. The field can align elements placed inside it, arranging them according to their own lines of strength. The way in which it is arranged is also tied to the specific formal language of an area and of a period in time. We can also think of a motionless field to which tensions are applied to alter it. The same forces which alter the field also tend to alter the elements placed within it. Such elements may be considered individually and so are completely tied to the field and, the alterations it undergoes. If, on the other hand, they are considered as a group, they can be expressed in terms of the geometric relationship which connect them. We can further define a degree of importance or a hierarchy for these relationships between the elements and as a relationship between the elements and the field. We can therefore define a resistance of the entity in the field to alter and move it with the field. Such a resistance can be expressed in the form of priorities of importance of a relationship in respect to others eg. in a calm field of an orthogonal grid, we can define the plan of a residence.

Let us impose a deformation of  $t'$  on the field without having placed any bind on the internal structure; we will have  $T(P) - P'$ , which is a typical image transformation.

If, on the other hand, we impose certain restrictions such as:

- the walls AB and AF must not be at an angle of less than 80 degrees with wall DC
- wall GH must remain orthogonal to wall CI, the result of the transformation will be

In the case of a piece of urban material, the simulation of a group with a low internal structure - as may be the case in a Medieval city, will strongly be rendered subject to field variations, with certain critical points where the gradient of curvature.

On the other hand with groups which have very rigidly structured internal relationships, more typical of functional Renaissance cities, there are many critical points which can be solved by destroying the sequence. Then the necessity arises to transgress the given restrictions or to force contextualisation.

In the form  $K'$  to  $K''$  the dimensions of the parameters of the figure can vary from a minimum of  $K'$  to a maximum of  $K''$ . Such a variation can take place with various types of criteria from linear types which can be considered implicit to a criterium of variation described by a gaussian type curve. In this dimension with a progressive reduction towards the more extreme cases. It

is possible to check the accuracy of branches of the curve or the maximum point at the start and at the end.

SHAPES WITH A  
NON-ORTHOGONAL  
FIELD VARIATION

*example of a TYPE OF HEAD of dynasty with associated rules of variation (figure)*

Example of generation of a family of recombined types (fig. ..).  
For the selection and composition there are enough drafting systems reaching the figure covering of each face of the shell from the dimensioned volume.

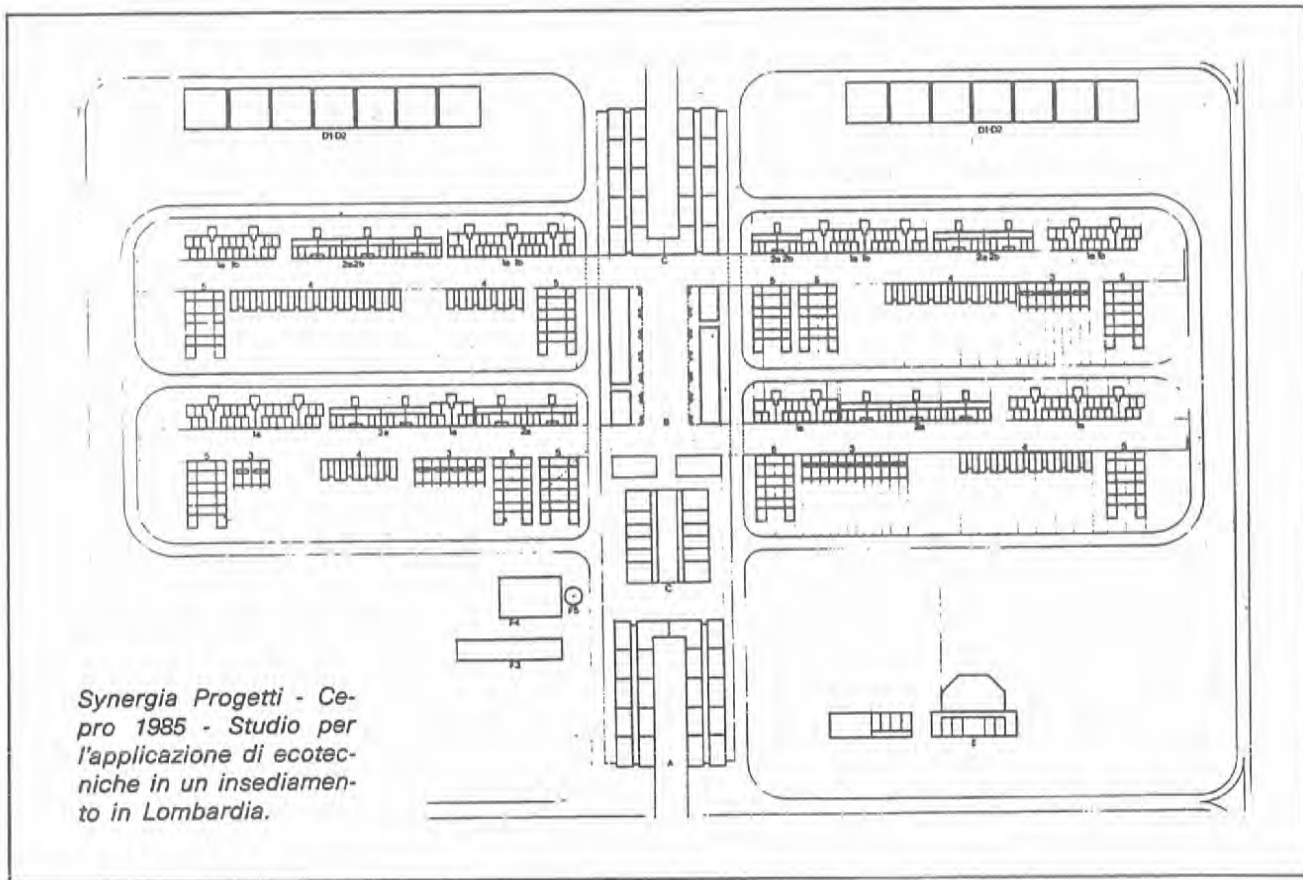

At the end of the operation a group of types may be arranged which constitute possible alternative solutions to the expressed request. There are further aspects to be considered in the process of selection. One of these aspects regards the internal mechanism of organization of the question and search for the answer included in the repertoire. On the other hand a second aspect regards the way in which the designer interacts with this mechanism. We accept, in this article, that the management of this system is practically impossible without the aid of an elaborator.

Let us first examine the second aspect.

The group of figures which forms the repertoire is subdivided into a series of groups of limited size, which we will refer to as "pages" of the repertoire. Each page contains figures whose construction description is already given in the preceding pages. These figures are classified level of use, such pages can later be produced, printed on paper like real pages in a catalogue. Each figure will be in order in the general catalogue based on its particular code of performance.

By leafing through the pages of the catalogue, the types which correspond with the request can be identified. The catalogue consists of sheets which can be placed on a graph: a procedure allows the program to identify the sheet; the figure can be recalled by using the cursor to select the boxes corresponding to the figure.

The way in which selection takes place in this first formulation is similar to the consultation of a conventional repertoire. The differences between this and existing architectural catalogues are due to the fact that our archive is organised according to classified criteria, whereas those in circulation have above all disorganised material. Also the fact that this system relies on an elaborator means that it is a type of filing which is already disposed towards being "active".

For the next step, an important factor must be taken into consideration. A data-bank must be consulted via search keys. There are many cases - especially in a discipline like architecture which has little systematics - where it is impossible to formulate precise questions, but often one has to work in approximations.

The structure which we have given our repertoire brings no directly to hypothesize that the definition the required performance is a type of knowledge which can be treated by an expert system.

The problem of identifying the sub-group of types which correctly fulfil the performance requested by the project's program can be described by means of a series of assertions using which the area of search for possible replies can be progressively restricted. This method presents a further advantage. Detailed specification of the performance is obtained by posing a series of questions to the designer. Using previous methods the task of fulfilling the correct considerations in terms

of evaluating and specifying the performance requested fell completely to the designer. Obviously the responsibility for decisions taken by the designer remain the same but now with the aid of an expert system, significant aspects of the problem should not be overlooked or comitted.

## THE PLACING OPERATOR

The figure can at this point be placed into the composition. The placing allows a series a series of rigid transformations which do not modify the figure itself but employ its position.

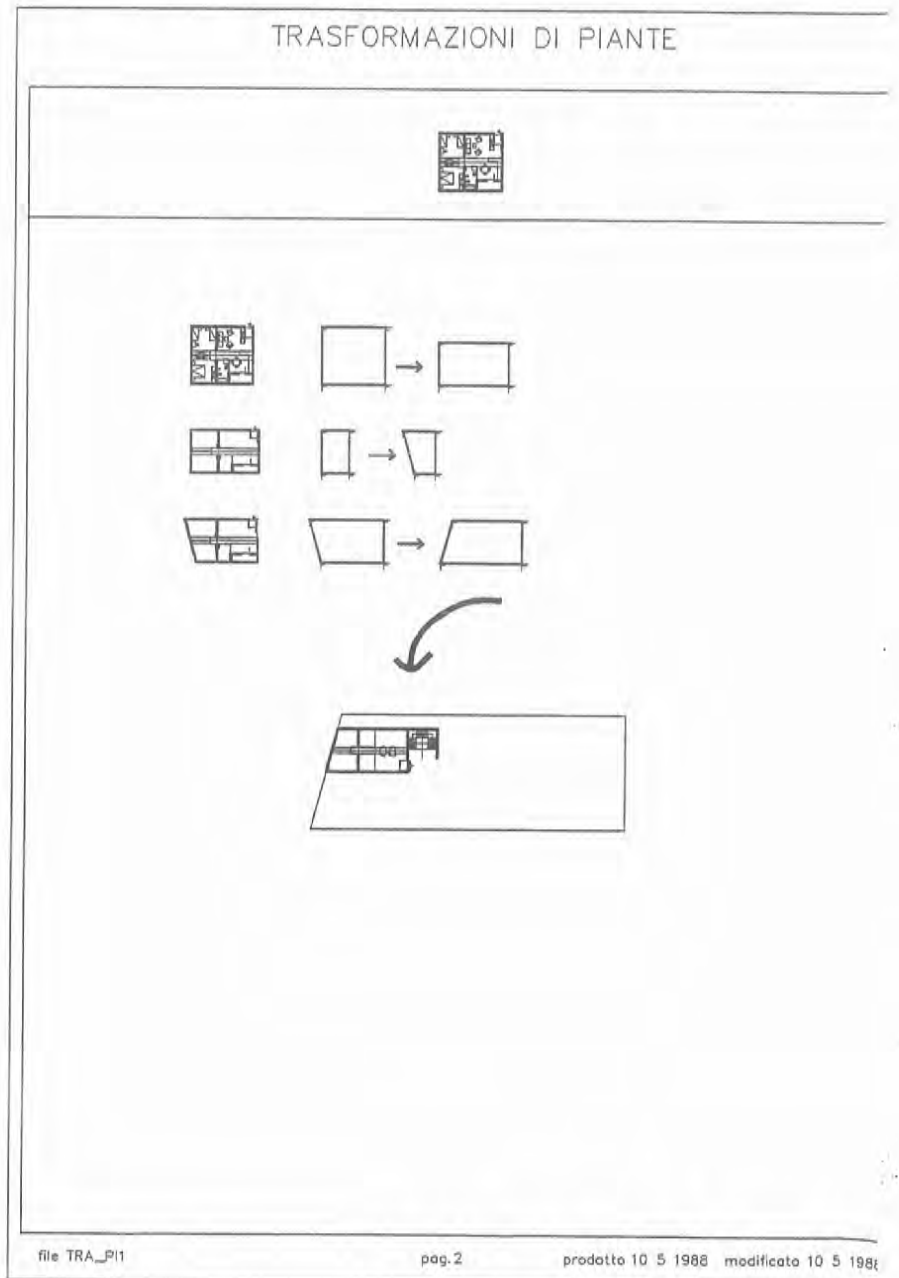

THE TYPOLOGIC GRAMMAR FOR NORTH ITALY

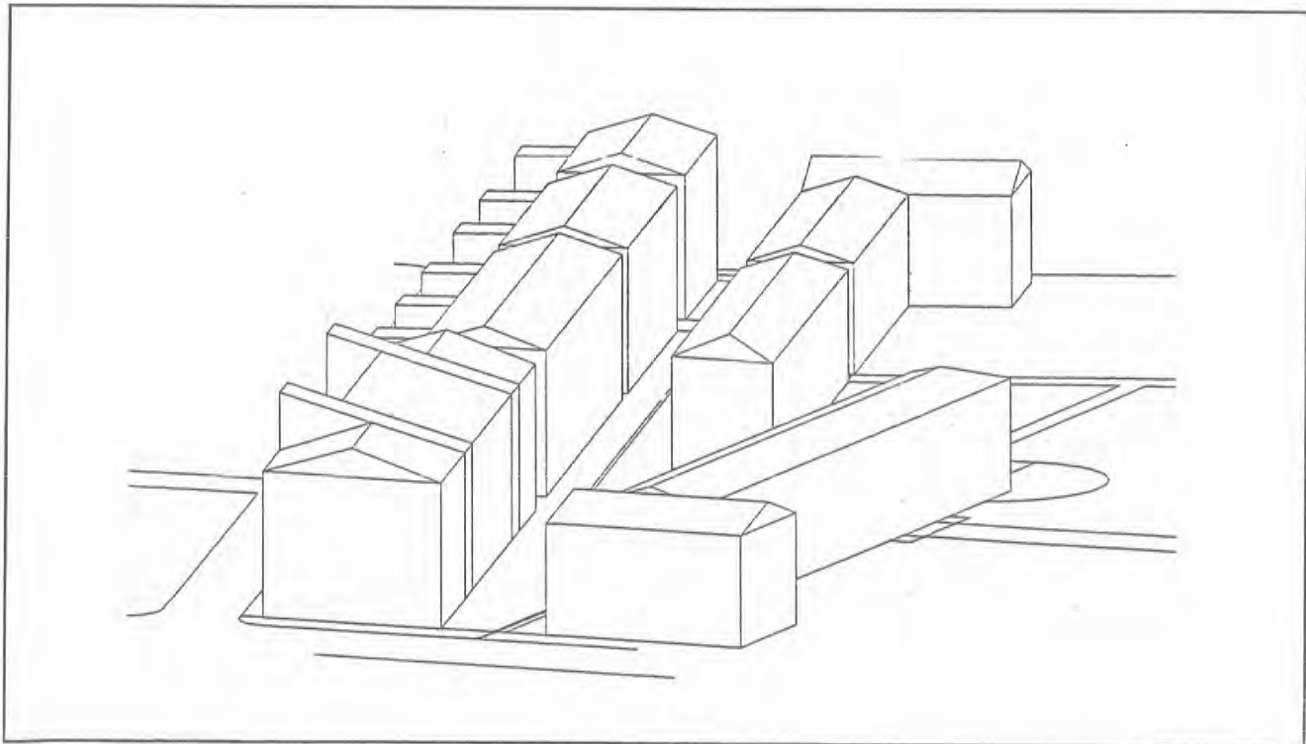
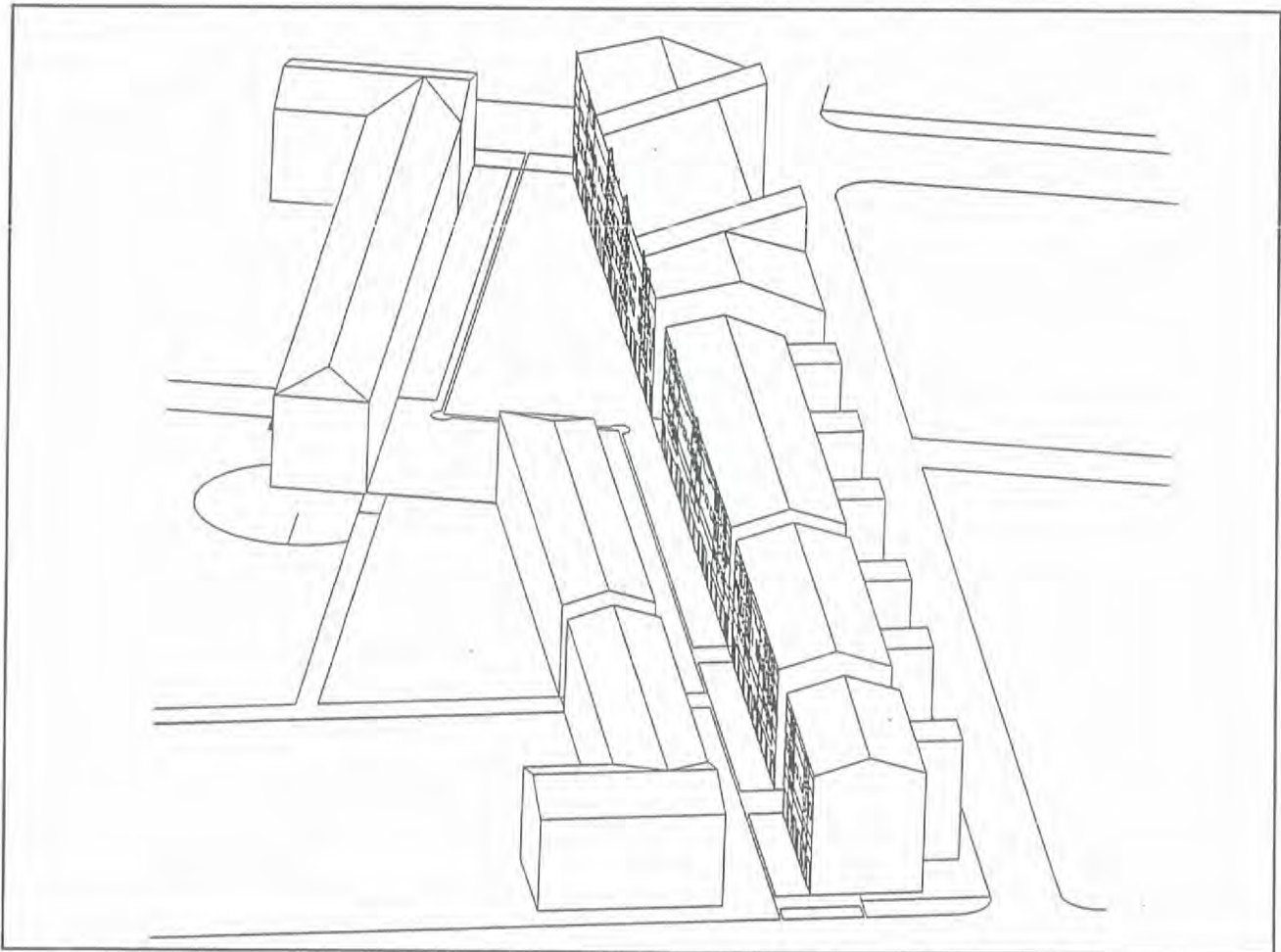

THE REGIONALIST DESIGN LANGUAGE METHOD

