

# SOLAR ENERGY SYSTEMS IN ARCHITECTURE



integration criteria and guidelines



Report T.41.A.2: IEA SHC Task 41 Solar energy and Architecture

# **SOLAR ENERGY SYSTEMS IN ARCHITECTURE**

integration criteria and guidelines

*Keywords*

*Solar energy, architectural integration, solar thermal, photovoltaics, active solar systems, solar buildings, solar architecture, solar products, innovative products, building integrability, integration examples.*

Editors MC Munari Probst, C Roecker

September 2012





## AUTHORS AND CONTRIBUTORS AFFILIATIONS (IN ALPHABETICAL ORDER):

**Marja Edelman (contributor)**

*Formerly of* EPFL-LESO  
Bâtiment LE  
Station 18  
CH-1015 Lausanne  
SWITZERLAND  
marja.edelman@epfl.ch

**Marja Lundgren (contributor)**

White Arkitekter  
P.O. Box 4700  
Östgötagatan 100  
SE-116 92 Stockholm  
SWEDEN  
marja.lundgren@white.se

**Kim Nagel (contributor)**

*Formerly of* SUPSI, Institute for Applied Sustainability to the Built Environment (ISAAC)

Swiss BiPV Centre of competence  
Campus Trevano  
CH - 6952 Canobbio  
SWITZERLAND  
info@bipv.ch

**Francesco Frontini (author)**

University of Applied Sciences and Arts of Southern Switzerland (SUPSI)  
Institute for Applied Sustainability to the Built Environment (ISAAC)  
Campus Trevano  
CH - 6952 Canobbio  
SWITZERLAND  
francesco.frontini@supsi.ch

**Maria Cristina Munari Probst (editor/author)**

Subtask co-leader, Subtask A  
Laboratoire d'Énergie Solaire (LESO)  
Ecole Polytechnique Fédérale Lausanne  
EPFL-Bâtiment LE - Station 18  
CH-1015 Lausanne  
SWITZERLAND  
mariacristina.munariprobst@epfl.ch

**Alessandra Scognamiglio (author)**

ENEA (Italian National Agency for New Technologies, Energy and Sustainable Economic Development) UTTP Portici  
Piazzale E. Fermi 1  
I-80055 Portici, NA  
ITALY  
alessandra.scognamiglio@enea.it

**Alessia Giovanardi (contributor)**

EURAC research  
Viale Druso/Drususallee 1  
I-39100 Bolzano/Bozen  
ITALY  
alessia.giovanardi@eurac.edu

**Christian Roecker (editor/author)**

Subtask co-leader, Subtask A  
Laboratoire d'Énergie Solaire (LESO)  
Ecole Polytechnique Fédérale Lausanne  
EPFL-Bâtiment LE - Station 18  
CH-1015 Lausanne  
SWITZERLAND  
christian.roecker@epfl.ch

**Mark Snow (contributor)**

Senior Researcher  
Faculty of the Built Environment  
University of NSW  
AUSTRALIA  
m.snow@unsw.edu.au

**Klaudia Farkas (author)**

Department of Architectural Design History and Technology  
Norwegian University of Science and Technology - NTNU  
NO-7491 Trondheim  
NORWAY  
klaudia.farkas@ntnu.no

**Laura Maturi (author)**

EURAC research,  
Institute for Renewable Energy  
Università degli Studi di Trento  
Viale Druso 1, I-39100 Bolzano  
ITALY  
laura.maturi@eurac.edu

**Isa Zanetti (author)**

*Formerly of* SUPSI, Institute for Applied Sustainability to the Built Environment (ISAAC)  
Swiss BiPV Centre of competence  
Campus Trevano  
CH - 6952 Canobbio  
SWITZERLAND  
info@bipv.ch

**Maria Wall (Operating Agent, contributor)**

Energy and Building Design  
Lund University  
P.O. Box 118  
SE-221 00 Lund  
SWEDEN  
maria.wall@ebd.lth.se



## ACKNOWLEDGMENTS

The authors are grateful to the International Energy Agency for understanding the importance of this subject and accepting to initiate a task on Solar energy and Architecture. We wish to thank all our respective national Executive representatives and National funding bodies for funding this work, namely:

- Swiss Federal Office of Energy (OFEN)
- Ecole Polytechnique Fédérale de Lausanne (EPFL)
- Scuola Universitaria della Svizzera Italiana (SUPSI)
- Stiftung Südtiroler Sparkasse (Fondazione Cassa di Risparmio di Bolzano)
- European Academy of Bozen/Bolzano (EURAC)
- Università degli Studi di Trento
- ENEA - Agenzia nazionale per le nuove tecnologie, l'energia e lo sviluppo economico sostenibile
- SINTEF Building and Infrastructure, Norway (to be confirmed by KF)
- Norwegian University of Science and Technology (NTNU)
- Swedish Energy Agency
- ARQ, body of two foundations established by White arkitekter
- Arkus - Foundation for Research and Development in Architecture and the Built Environment

We wish to truly thank Mark Snow for his English polishing of the whole document.

Finally, our gratitude goes to our helpful Operating Agent Maria Wall, and to Anne Grete Hestnes and Jens Windeleff for their initial crucial support to this task.





# CONTENTS

## ACKNOWLEDGMENTS

## EXECUTIVE SUMMARY

### 1. INTRODUCTION

1.1	Solar energy	5
1.2	Building energy needs and available solar technologies	5
1.3	Building integration problematic	6

### 2. ARCHITECTURAL INTEGRATION QUALITY

2.2	Definition	7
2.3	Functional and constructive aspects	7
2.4	Formal aspects (aesthetics)	8

### 3. APPLICATION TO TECHNOLOGIES

#### PART A: SOLAR THERMAL TECHNOLOGIES 13

3A.1	Available solar thermal technologies	13
3A.2	System sizing and positioning	18
3A.3	Integration possibilities in the envelope	20
	Good integration examples	22
3A.4	Formal flexibility of existing products	35
3A.5	Innovative products	37

#### PART B: PHOTOVOLTAIC TECHNOLOGIES

3B.1	Introduction	83
3B.2	Photovoltaics (PV)	83
	PV available technologies	
	PV system	
3B.3	Energy output - Area - Cost	90
3B.4	Integration possibilities in the building envelope	96
	Good integration examples	104
3B.5	PV products and formal flexibility for building integration	151
	Innovative products	156

### 4. PHOTOVOLTAICS VS SOLAR THERMAL:

#### VERY DIFFERENT INTEGRATION POSSIBILITIES AND CONSTRAINTS

4.1	Introduction	201
4.2	Complementarity elements	201
4.3	Significant collectors' formal characteristics	202
4.4	Energy transport and storage	205
4.5	Operating constraints	207
4.6	Conclusions	207

### 5. CONCLUSIONS 211

## ANNEX: IEA SOLAR HEATING AND COOLING PROGRAM 213



## EXECUTIVE SUMMARY

The building sector is responsible for about a third of the total energy consumption of western countries. The use of solar energy in buildings is becoming of critical importance if we are to prepare for fossil fuel energy shortages and reduce our exposure to global warming impacts and associated environmental costs. In this regard, there is a pressing need for architects to complete competencies in this field.

The present manual, conceived for architects and intended to be as clear and practical as possible, summarizes the knowledge needed to integrate active solar technologies into buildings, handling at the same time architectural integration issues and energy production requirements.

The document is organized into two major parts, following a short introduction (chapter 1).

The first part (chapter 2) is general and focuses on the definition of architectural integration quality and related criteria.

The second (chapter 3) outlines possible practical ways that lead to high quality outcomes. Solar thermal and Photovoltaics are treated separately, since one technology is designed to transform the solar radiation into heat, while the other is designed to transform it into electricity: two different energies, with very different transportation, storage, and safety issues. This brings different formal and operating constraints, leading to different integration possibilities.

Solar Thermal (ST) is treated in section 3A and Photovoltaics (PV) in section 3B following a similar structure:

- Main technical information: technology working principle; available “sub technologies”; related basic collector components; suitable energetic applications; energy yield; cost; etc...
- Constructive/functional integration possibilities in the envelope layers.
- System sizing and positioning criteria (to help integrate the system taking into account all design criteria, area and solar radiation availability, targeted solar fractions and storage issues).
- Formal flexibility offered by the available products: general design freedom, good examples of integration, and available innovative products.

The document ends with a section (ch.4) dedicated to the differences and similarities between Solar Thermal and Photovoltaics, as a support for an energetic and architecturally optimized use of the available sun exposed surfaces of buildings.



## 1. INTRODUCTION

*MC Munari Probst, C Roecker*

### SOLAR ENERGY

In recent times, the world has fortunately become increasingly cognisant of the significant potential of solar energy as a replacement for non-renewable fossil fuel energy. The sun is a clean, unlimited and almost infinite energy source, providing each hour on earth as much energy as the whole world needs in a year. Proven technologies are able to transform its radiation into heat, electricity and even cold, and are now largely available at affordable prices.

### BUILDING ENERGY NEEDS AND AVAILABLE SOLAR TECHNOLOGIES

Solar energy, in its active or passive forms, is able to deliver the entire set of building energy needs: space heating and lighting, domestic hot water (DHW), electricity, and recently also space cooling (fig.1.1) .

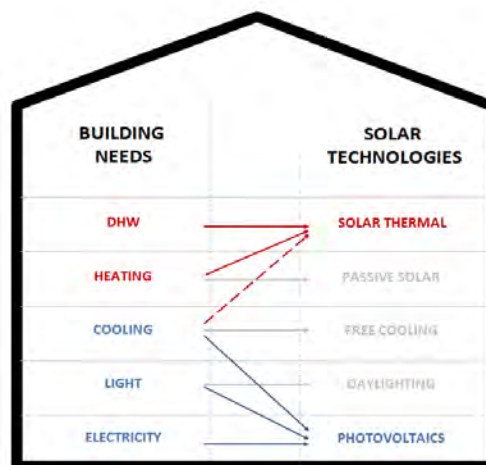

Fig.1.1. : Different solar technologies covering different building energy needs. Credits: EPFL/LESO-PB

- Domestic hot water (DHW) can be produced using active solar thermal collectors;
- Space heating can be easily provided by the direct (passive) solar gains heating the building through the windows (greenhouse effect). The needed heat can also be provided indirectly, by using active solar thermal collectors;
- Electricity for appliances can be produced by photovoltaic modules;
- Space lighting should be provided as far as possible by using passive sun light (day lighting), photovoltaic modules can then provide what is needed for electric lighting;

- Space cooling can be greatly supported by appropriate passive night ventilation (free cooling). Recently solar thermal systems able to transform solar heat into cold have been developed, helping deliver building cooling needs. These systems use standard solar thermal collectors, but are for the moment mostly available as experimental systems for pilot projects.

### **BUILDING INTEGRATION PROBLEMATIC**

It is very important to underline that the different solar technologies presented here above complete each other, rather than being in competition. To reduce to a minimum their fossil energy consumption, low energy buildings will have in most cases to use all of them. Consequently, architects will have to deal with the architectural integration issues they bring.

These issues are more or less complex depending on the maturity of the technology in relation to building use. The passive use of solar gain for space heating or day lighting is somehow part of the architectural design process since ever. Since it does not really bring new elements in the building envelope nor particular integration issues, it will not be further addressed in this document.

We will instead concentrate on the active technologies, bringing in the building envelope new elements not yet metabolized by architecture, i.e. solar thermal collectors and photovoltaic modules.

## 2. ARCHITECTURAL INTEGRATION QUALITY

*MC Munari Probst, C Roecker*

### 2.2 DEFINITION

Architectural integration quality is defined as the result of a controlled and coherent integration of the solar collectors simultaneously from all points of view, functional, constructive, and formal (aesthetic) [2.1]. I.e. when the solar system is integrated in the building envelope (as roof covering, façade cladding, sun shading, balcony fence...), it must properly take over the functions and associated constraints of the envelope elements it is replacing (constructive/functional quality), while preserving the global design quality of the building (formal quality). If the design quality is not preserved (i.e. the system is only constructively/functionally integrated into the building skin without a formal control), we can only call it a building integrated system [2.2] [2.3] [2.4] [2.5] [2.6] [2.7][2.11].

### 2.3 FUNCTIONAL AND CONSTRUCTIVE ASPECTS

The building envelope has to fulfill a wide and complex set of protection and regulation functions, requiring the use of different structures and components (opaque/trans-parent elements, monolithic/multilayer structures, composed of fixed/mobile parts,...). The integration of solar modules in the envelope system should then be studied very carefully, to preserve/ensure the standard envelope functions and the durability of the whole.

The multifunctional use of solar elements taking over one or more envelope functions may require an extra effort to building designers, calling for instance for some modifications in the original design of the collector, in the way it is mounted or by restraining its use in some parts of the building. On the other hand, it brings the major advantages of a global cost reduction and an enhanced architectural quality of the integration.

In addition to the functional compatibility, it is important to ensure that the new multifunctional envelope system meets all building construction standards:

- The collector load should be correctly transferred to the load bearing structure through appropriate fixing;
- The collector should withstand fire and weather wear and tear;
- It should resist wind load and impact, and should be safe in case of damage;

- Risks of theft and/or damage related to vandalism should be evaluated and appropriate measures taken;
- The fixing should avoid thermal bridges and the global U value of the wall should not be negatively affected;
- Vapour transfer through the wall should avoid condensation layers, and allow the wall to dry correctly.

Besides these standard building construction constraints, the integration of solar systems implies other issues resulting from specific solar technology attributes, i.e. the presence of a hydraulic system (for ST) or electric cabling (for PV) and the high temperatures of some modules.

- The hydraulic system of ST should be carefully studied to deal with water pressure differences at the different façade levels (heights), should be safely positioned within the envelope structure and should remain accessible; measures to avoid damages resulting from water leakage should also be taken;
- The electric cabling of PV should be studied to avoid shock hazards and short circuits, and measures should be taken to avoid fire.
- Envelope materials in contact with the solar modules should withstand their high working temperature;
- Fixing details and jointing should make collector's materials expansions compatible with those of the other envelope materials;
- Safety issues should be considered for collectors within users' reach to avoid burning or shock hazards (ground floor, window and balcony surrounding...).

As seen, integrating the new function "solar collection" into the building envelope requires an understanding of where (opaque parts, transparent parts, fixed/mobile elements), how, and which collectors can be made compatible with the other envelope elements, materials, and functions.

Each technology or sub-technology has different implementation possibilities in different parts of the envelope. This will be discussed in detail in technologies dedicated sections (ch.3 A.2 for ST and 3.B.2 for PV) [2.8] [2.9] [2.10].

## 2.4 FORMAL ASPECTS (AESTHETICS)

All the system characteristics affecting building appearance (i.e. system formal characteristics) should be coherent with the overall building design (see also good integration examples in chapter 3-A and 3-B, p.20 to 33 and p.105 to 149):

- The position and dimension of collector field(s) have to be coherent with the architectural composition of the whole building (not just within the related façade)
- Collector visible material(s) surface texture(s) and colour(s) should be compatible with the other building skin materials, colours and textures they are interacting with.
- Module size and shape have to be compatible with the building composition grid and with the various dimensions of the other façade elements.
- Jointing types must be carefully considered while choosing the product, as different jointing types underline differently the modular grid of the system in relation to the building.



Clearly, mastering all characteristics of an integrated solar thermal system in both perspectives of energy production and building design is not an easy task for the architect.

The formal characteristics of the system are strongly dependent on the specific solar technology, which imposes the core components of the solar modules, with their specific shapes and materials.

The more flexibility that can be offered within these imposed forms and materials, the more chances for a successful integration [2.11] [2.12].

The actual flexibility of solar modules (we will call it “integrability”) is presently very different in the two fields of ST and PV, as we will see in detail in sections 3A4 and 3B4, making the integration design work either more or less challenging.

### References

- [2.1] Marcus Vitruvius Pollio, *De Architectura*, 30-20 bC, Pierre Gros editor, Einaudi, 1997. Also available on-line: [www.penelope.uchicago.edu/Thayer/E/Roman/Texts/Vitruvius/home](http://www.penelope.uchicago.edu/Thayer/E/Roman/Texts/Vitruvius/home).
- [2.2] T. Herzog “Solar Design”, in *Detail* n°3/1999, ed. Birkhauser.
- [2.3] R. Krippner “Solar Technology – From Innovative Building Skin to Energy-Efficient Renovation”, in *Solar Architecture*, Christian Schittich (Ed.), Birkhauser, Edition *Détail* 2003.
- [2.4] A. G. Hestnes “Building integration of solar energy systems”, in *Solar Energy* vol.67, n.4-6, 2000.
- [2.5] A.G. Hestnes “The integration of solar energy systems in architecture”, in *Proceedings Eurosun 1998*
- [2.6] I.B. Hagemann “Gebäudeintegrierte Photovoltaik – Architektonische Integration der Photovoltaik in die Gebäudehülle”, Ed. Rudolf Müller 2002.
- [2.7] T. Reijenga “What do architects need?”, *Proceedings of the IEA PVPS Task 7*, 2000.
- [2.8] R. Krippner “L’enveloppe productrice de chaleur et génératrice d’électricité”, in *Enveloppes - Concepts, Peaux, Matériaux*. Sous la direction de Christian Schittich. Birkhauser, Edition *Détail* 2003.
- [2.9] T. Herzog, R. Krippner, W. Lang, *Façade construction manual*, Birkhauser, edition *Detail*, 2004.
- [2.10] C. Schittich, *Enveloppes - Concepts, peaux, matériaux*, Editor Christian Schittich. Birkhauser, Edition *Détail* 2003.
- [2.11] MC Munari Probst, C Roecker, *Architectural integration and design of solar thermal systems*, PPUR -Routledge, Taylor&Francis, 2011
- [2.12] MC.Munari Probst, C.Roecker, *Towards an improved architectural quality of building integrated solar thermal systems (BIST)*, in *Solar Energy* (2007), doi:10.1016/j.solener.2007.02.009.



## **PART 3**

### **APPLICATION TO TECHNOLOGIES**



## PART A: SOLAR THERMAL TECHNOLOGIES

*Authors : MC Munari Probst, C Roecker*

*Contributors : Marja Lundgrne, Marja Edeman, Alessia Giovanardi*

### 3A.1. AVAILABLE SOLAR THERMAL TECHNOLOGIES

Solar thermal energy can be used for different building applications: direct or indirect space heating, domestic hot water production (DHW), and very soon also for building cooling. It can be collected in different ways, using different technologies.

- passively, through the transparent parts\* of the building envelope, storing the gains in the building mass itself. These systems can only be used for space heating, and will not be further considered here as they are part of the standard knowledge of today's architects.
- actively on surfaces optimized for heat collection (solar absorbers) placed on the outside of the building envelope, and transported by a medium either directly to the place of use or to a storage.

Among active systems, two main families can be identified according to the medium used for the heat transport: air collectors systems and hydraulic collectors systems.

- Air systems are characterized by lower costs, but also lower efficiency than hydraulic ones, mainly due to air low thermal capacity. Solar thermal gains are generally used immediately and without storage, for pre-heating the fresh air needed for building ventilation (figs.3.A.1 - 2). The heat can also be stored by forcing the air to circulate in a stones bed underneath the ground, or by using the solar air as cold source in a heat pump air/water; such applications can be quite expensive, and are therefore rare. Like passive systems, air systems can only be used for space heating and will not be further considered here.

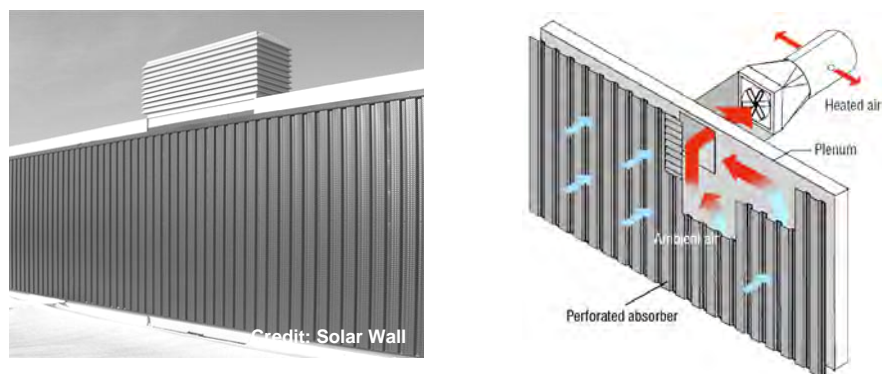

Fig.3.A.1 - 2: Solar Wall collector system (left). Air collector system working principle (right). Based on an image made by the US Department of energy, National Renewable Energy laboratory [http://en.wikipedia.org/wiki/File:Transpired\\_Air\\_Collector.PNG](http://en.wikipedia.org/wiki/File:Transpired_Air_Collector.PNG).

- Hydraulic systems represent the bulk of solar thermal systems for buildings. As opposed to air systems, they allow an easy storage of solar gains and are suitable both for domestic hot water (DHW) production and for space heating. Being cost effective, they are crucial to help reducing building fossil fuel energy consumption (figs.3.A.3, 3.A.4).

Hydraulic solar thermal systems can be divided into three technologies (\*):

- Evacuated tubes collectors;
- Glazed flat plate collectors;
- Unglazed flat plate collectors;

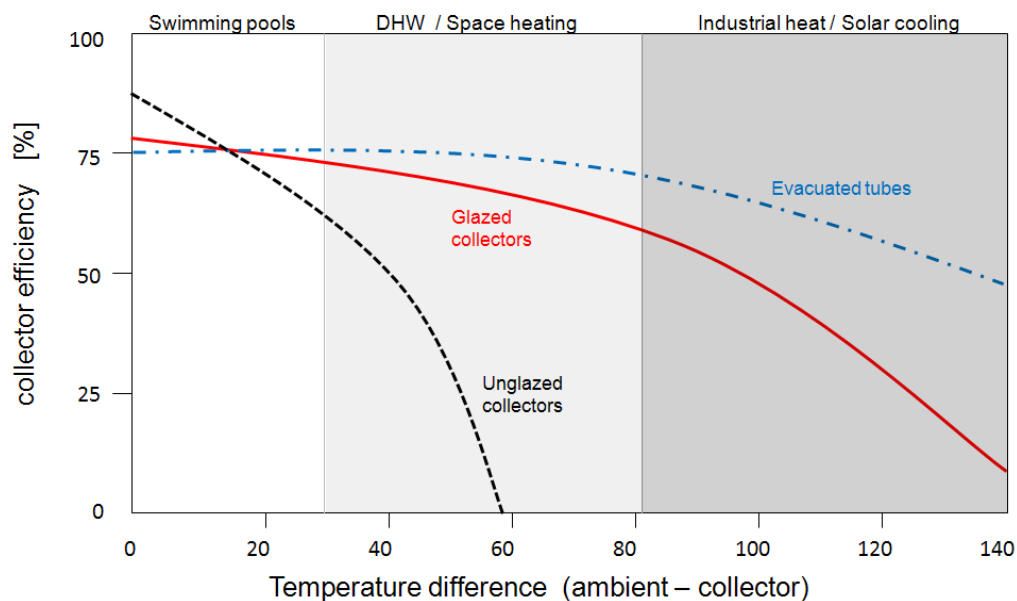

Fig.3.A. 3 : Comparison of the different solar thermal technologies relevant for DHW and space heating production in relation to their efficiency, cost, specific working temperatures, suitable applications.

All these systems collect solar radiation using an absorber made of a thin metal sheet with selective black coating (which maximizes solar energy absorption while minimizing infra-red losses), and use water as a medium to transport and store the collected heat. Even though all these collectors are suited for DHW and space heating, they have very different appearances, levels of efficiency and working temperatures; this results mainly from the different insulation levels of the solar absorbers, as specified in the next section. Fig. 3.A.3 shows the efficiencies and preferred application domains of the three technologies, as a function of the temperature differences between the collector and the ambient air. Fig. 3.A.4 summarizes the main characteristics of each technology.[ 3-A.1][ 3-A.2][ 3-A.3][ 3-A.4][ 3-A.5][ 3-A.6] [3-A.7]

(\*)Concentrating collectors do also exist but they are not really relevant for the topic of building integration treated here. This is also true for unglazed plastic collectors which, due to their very low working temperatures, are only used for swimming pool or aquaculture process water heating.

	GLAZED FLAT PLATES	UNGLAZED FLAT PLATES	EVACUATED TUBES
<b>Working temperatures</b>	50 -100°C	25-50°C	120°C
<b>Main applications</b>	DHW, space heating	Swimming pools, space heating, DHW pre-heating	DHW, space heating, solar cooling, industry
<b>Energy production</b> <i>(Switzerland, 6 m<sup>2</sup> field)</i>	400-600 kWh/m <sup>2</sup>	300-350 kWh/m <sup>2</sup>	480-650 kWh/m <sup>2</sup>
<b>Average cost</b> <i>(Switzerland, 2010, 6 m<sup>2</sup> field)</i>	370 €/m <sup>2</sup> (Price variation 320-480 €/m <sup>2</sup> )	220 €/m <sup>2</sup> (Price variation 200-260 €/m <sup>2</sup> )	800 €/m <sup>2</sup> (Price variation 500-1100€/m <sup>2</sup> )

Fig. 3.A.4: Characteristics of the different hydraulic solar thermal technologies

· Glazed flat plate collectors (fig. 3.A.5) are the most diffused in the EU and typical applications are DHW production and space heating.

They usually consist of 10 cm thick rectangular boxes of about 2 m<sup>2</sup>, containing several layers:

- a metal plate with a selective treatment, working as solar absorber
- a hydraulic circuit connected to the absorber
- a back insulation
- a covering glazing, insulating the absorber by greenhouse effect.

Usual working temperatures are between 50°C and 100°C, but they can rise up to more than 150°C in summer (mid latitude climates). Therefore, measures should be taken to avoid overheating risks which can damage sensible parts (rubber jointing for instance).

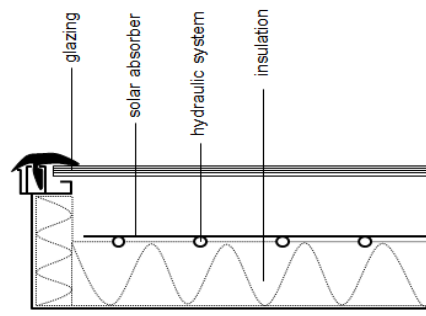

Fig 3.A.5 a- b: Glazed flat plate collectors applied on a tilted roof (left). Right: Typical glazed flat plate collector's cross section and main composition elements.

· Unglazed flat plate collectors (fig.3.A.6) are adequate for swimming pools, low temperature space heating systems and DHW pre-heating.

They are composed of a selective metal plate (the absorber) and a hydraulic circuit connected to this absorber. When used for DHW or space heating they also need a back insulation, but differently from glazed collectors, the front part of the absorber is not insulated by a covering glass. Consequently, working temperatures are lower, reaching 50-65°C. When used for swimming pool water heating, the back insulation is not needed. For this specific application, polymeric absorbers can also be used to replace the more performing -and more expensive- selective metal plates (most often black polymeric pipes systems).

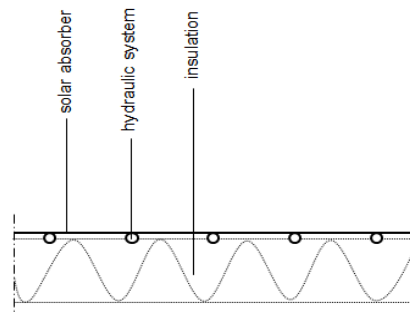
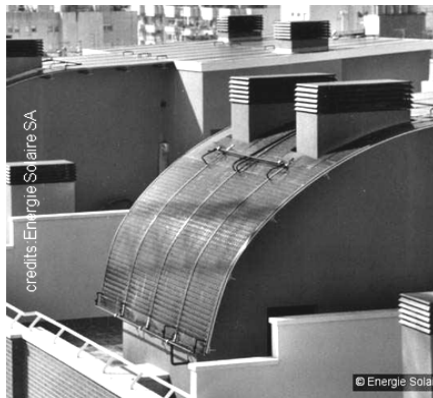

Fig 3.A.6 a- b: Unglazed flat plate collectors as roof covering (left). Right: typical unglazed flat plate collector's cross section and main composition elements.



· Evacuated-tube collectors (fig.3.A.7)

Evacuated tubes are especially recommended for applications requiring high working temperatures such as industrial applications and solar cooling, but are also used for domestic hot water (DHW) production and space heating, particularly in cold climates. They are composed of several individual glass tubes, each containing an absorber tube or an absorber plate bound to a heat pipe, surrounded by a vacuum. The very high insulation power of the vacuum allows reaching very high temperatures (120-180 °C) while keeping losses to a minimum even in cold climates.

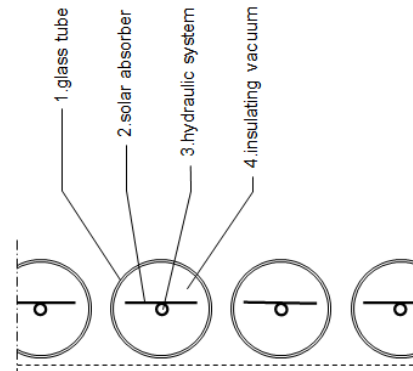

Fig 3.A.7 a- b: Vacuum tubes collectors mounted on a tilted roof (left). Right: typical vacuum tubes collector's cross section and main composition elements.

### 3A.2. SYSTEM SIZING AND POSITIONING

Several major factors must be considered when choosing, sizing and positioning a solar thermal system:

- Area availability on the different envelope parts
- Seasonal solar radiation on these surfaces
- Desired solar fraction (i.e. the portion of the building's energy covered by the solar system), and available storage possibilities.

As the solar radiation varies with the orientation, systems with lower exposure (fig 3.A.8) will need a larger collector area than well exposed ones to achieve the same solar fraction. This also holds true for technology efficiency: the higher the collector efficiency the smaller the needed collector area (Fig 3.A.4, previous section). Understanding the crossed impact of orientation and technology on system size is fundamental for a proper system choice.

To limit investment costs, solar thermal systems are usually oriented where the yearly solar radiation is maximized (45° tilted, facing south for EU mid latitudes), thus minimizing the needed collector area. This is a valid approach as long as the total energy produced by the system can be used by the building. But because of the summer peak production (fig. 3.A.9) this leads to solar fractions up to 50–60 % only, in mid-latitude.

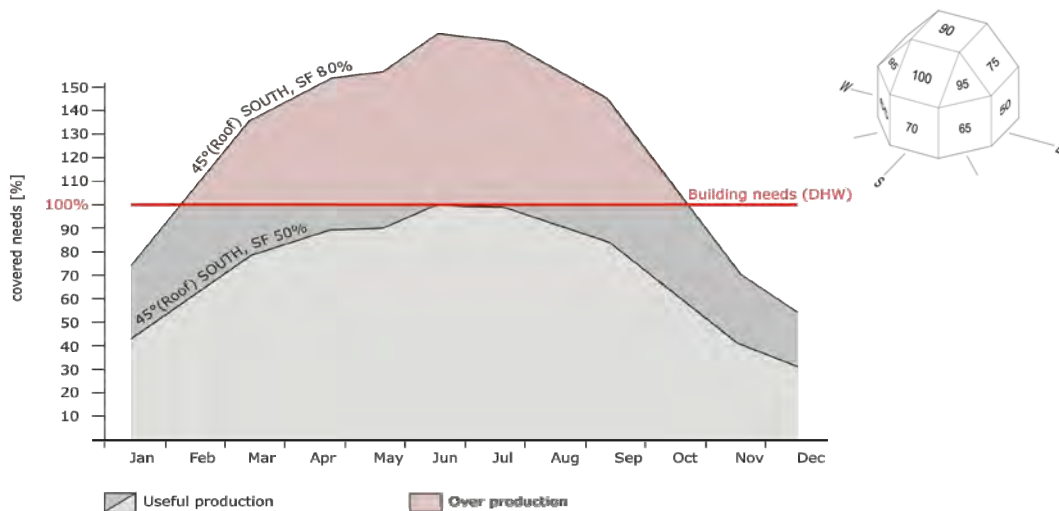

Fig. 3.A.8 (right) Yearly solar radiation in relation to orientation and surface inclination (mid latitudes, northern hemisphere).

Fig. 3.A.9: Comparison of the different annual production profiles of 2 systems (both south oriented, 45° tilted - mid-latitudes, north hemisphere) covering respectively 50% and 80% of DHW needs. No overproduction occurs in summer in the smaller system (50% of DHW) so that all the produced energy is used. The second system is dimensioned to cover 80% of the annual needs, but this implies an important overproduction in summer (red area).

This limitation is specific to solar thermal and is due to heat transportation and storage issues. Whereas the electricity produced by PV can be injected for storage in the electricity grid and transported with negligible losses, the heat produced by ST is subject to transport losses, and heating grids are very rare. Then, unless a district heating grid is available<sup>1</sup>, or a big seasonal storage for a cluster of buildings can be considered<sup>2</sup>, the heat produced by the system has to be stored within the limited volume of the storage tank, in the building itself. The useful solar heat is then only the part that can be directly used or stored. Any additional production is not only useless but increases the overheating risks and should be avoided.

<sup>1</sup>This possibility occurs rarely, mainly in Scandinavian countries.

<sup>2</sup>Only a few pilot projects available at present. Please refer to [www.solar-district-heating.eu](http://www.solar-district-heating.eu)

To increase the solar fraction while avoiding overproduction, an interesting approach is to take advantage of the almost constant irradiation level in the vertical plane (fig. A.3.10).

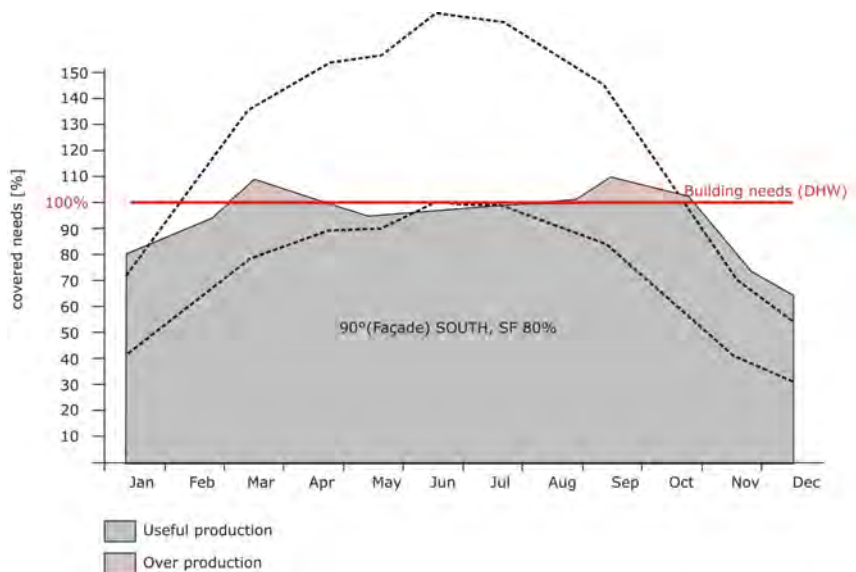

Fig. 3.A.10: Annual production profile of a solar thermal system mounted on a southern façade and covering 80% of domestic hot water needs (mid-latitudes, north hemisphere)

Thanks to their more "constant" energy production, façade integrated collectors can achieve very high solar fractions (up to 80-90 %) without overheating. Whereas for low solar fractions, to collect the same amount of energy, façades need about 40% more collector surface than roofs. This difference decreases substantially when aiming at higher solar fractions (less than 10% extra area for solar fractions over 70%)[3-A.8][ 3-A.9][3-A.1].



Fig. 3.A.11: Façade integrated solar thermal system. GAK Training centre in Graz, Austria. Arch: Josef Hohensinn

The relative complexity of dimensioning a system and its influence on integration possibilities often leads to an iterative process. To help architects evaluate the various options in the early stages of the design, when crucial decisions are taken concerning the building envelope, new tools are emerging to evaluate the energy needs and help pre-dimension a thermal system [3-A.13]. These tools allow a comparison of different configurations, combining different technologies, system placements and sizes (eg. LESOSAI7 - [www.lesosai.com](http://www.lesosai.com), Polysun Light -

[www.velasolaris.com](http://www.velasolaris.com), SOLTOP - <http://www.soltop.ch/de/main/solarrechner>, TSol Express - [www.valentin.ch](http://www.valentin.ch), Thermolog Epix - [www.logical.it](http://www.logical.it)).

The obtained information, together with a good knowledge of existing product characteristics and limitations, are the basis of the integration work. More detailed calculations for the final system can be done later, by a specialist using dedicated tools (eg. Polysun, TSol, Sim Sol, BM Solare, Solarius; please refer to IEA-SHC task41 Report T.41.B.3a: Solar Design of Buildings for Architects: Review of Solar Design Tools [3.A.13]).

The flexibility to choose from different combinations of technologies, sizes and orientations for the same result offers the architect the needed freedom for a successful architectural integration outcomes.

### 3.A.3. INTEGRATION POSSIBILITIES IN THE ENVELOPE

As they need solar radiation to work, solar collectors must be placed on sun-exposed areas of the building envelope. They can either be merely applied on top of the building skin, or properly integrated into the envelope constructive system.

Installers often choose the technically less complex first approach and treat the solar system just as an added technical element, with mitigated architectural results.



Fig. 3.A.12: Integration of collectors as added elements on the roof.

For the second approach, which is in general more appealing for architects, the different characteristics of the technologies described above must be considered in order to evaluate integration possibilities in the envelope (transparent/opaque parts, mobile/fixed, multilayered/single layered ...). As described below (section 3.A.4), the products' specifications and their often limited formal flexibility have to be considered when choosing an option [3-A.1][3-A.10][3-A.11].

The structure of flat plate collectors (glazed and unglazed) is well adapted to replace parts of roof coverings or façade cladding. The insulation behind the absorber plate and the insulation of the building envelope can be merged to become one single element, or they can complement each other. The water tightness and insulation can be directly overtaken by the absorber plate for unglazed collectors, or by the front glazing for glazed ones.

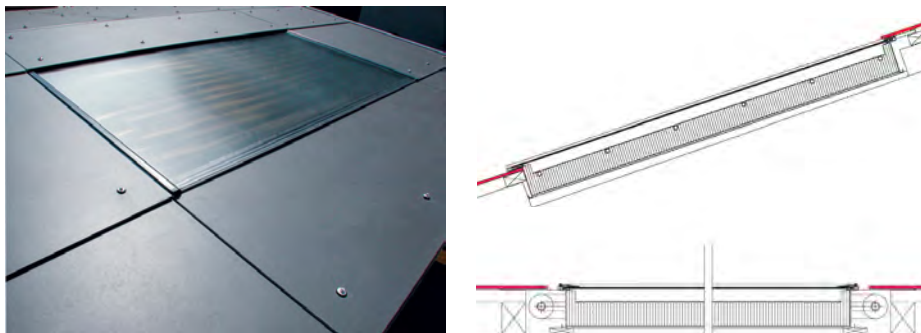

Fig. 3.A.13: Integration of a glazed flat plate collector as part of the multilayer roofing system, picture and details. Credits Eternit / Soltop, [www.etermit.ch](http://www.etermit.ch); [www.soltop.ch](http://www.soltop.ch)



Fig. 3.A.14: Façade integration of glazed flat plate collectors as façade cladding, detail and picture.  
Credits AKS Doma, [www.aksdoma.com](http://www.aksdoma.com)



Fig. 3.A.15: Roof integration of unglazed flat plate collectors used as roof covering. Credits Energie Solaire SA

Fig. 3.A.16: Façade integration of unglazed flat plate collectors used as façade cladding. Credits Energie Solaire .

The structure and appearance of evacuated tubes somehow limit their integration possibilities into the envelope itself, but applications like balcony eaves or sun shading elements are open.



Fig.3.A.17: Evacuated tubes collectors used as deck sun shading. RaU Architekten. Credits: RaU Architekten.

Fig. 3.A.18: Evacuated tubes collectors used as balcony eaves, arch. Beat Kaempfen. Credits Beat Kaempfen.



Fig.3.A.19: Evacuated tubes collectors used as glazed roof sunshading (left: inside view, right:outside view), Dubendorf Residential building, Beat Kaempfen 2008.

Sun shading applications are also possible for flat plate collectors, but their thickness and water connections can be problematic, therefore PV is usually preferred.

In very hot climates, double roof systems providing horizontal building shading and producing energy could be very effective for minimizing both building heat loads and energy consumption. PV systems can be perfect for this kind of application, but vacuum tube systems used for solar thermal cooling could also be a very effective, and architecturally attractive solution, yet not explored at present (Fig. 3.A.20-a-b-c)



Fig. 3.A.20-a-b-c: Examples of double roofs conceived to reduce building heat (a: double tin roof in Arizona architect n.a; b and c: double roof on a private house in Arizona. Architect Judit Chafee, credits Marja Lundgren).

### Good integration examples

In the following section a few relevant examples of building integration of solar thermal systems are presented and their architectural integration achievements are analysed. The criteria used to evaluate the integration quality are set to ensure both the analysis of the functional/constructive integration quality into the building envelope ("Collector used as multifunctional construction element"- see section 2.3 Functional and constructive aspects, p. 7 of this document.) and the formal quality of the integration design ("Field position and dimension"; "Visible materials"; "Surface textures"; "Surface colours"; "Module shape and size"; "Jointing" - see section 2.4 Formal aspects, p. 8 of this document) [3-A.1][3-A.12].

## UNGLAZED FLAT PLATE COLLECTORS

### Swimming pool, Freibad Ilanz, Switzerland, 1996, arch. P. Cruschellas

#### Building facts

Climate type: Mountain area (Alpine region)

Building size: three outside uncovered pools, total pool surface 1'250m<sup>2</sup>

Energetic standard: none

Application: swimming pool heating and domestic hot water (showers).

#### Solar product

Manufacturer: Energie Solaire SA -Z.I. Falcon, CH-3960 Sierre, Switzerland

Website: [www.energie-solaire.com](http://www.energie-solaire.com)

Module size: 248 x 86 x 0.5 [cm] / solar effective : 1.93 m<sup>2</sup>

System size: 453 m<sup>2</sup> (353m<sup>2</sup> on curved roof + 100m<sup>2</sup> on tilted roof)

Energy output: 95% of DHW needs (pools open only in summer)

#### Integration achievements

Collector used as multifunctional construction element	+
Field position and dimension	+
Visible materials	+
Surface texture	+
Surface colour	+
Module shape & size	+
Joining	+

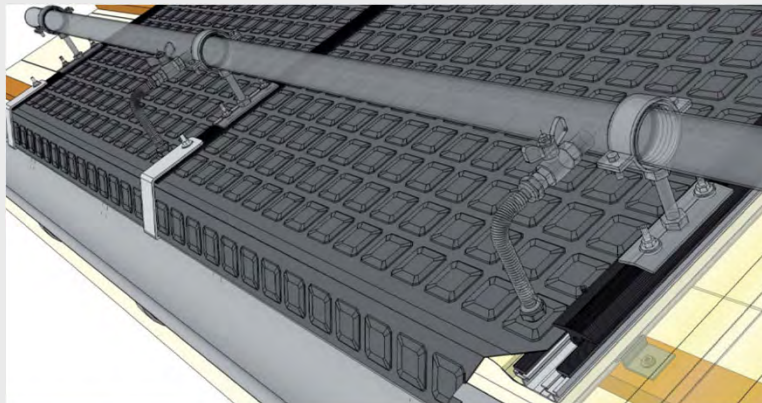





## UNGLAZED FLAT PLATE COLLECTORS

### CeRN buildings, Bursins, Switzerland, 2004-2007, arch. Niv-0, Lausanne

#### Building facts

Climate type: continental

Building size: 8'600 m<sup>2</sup> / 46'800 m<sup>3</sup>

Energetic standard: Minergie Eco label

Application: Unglazed metal collectors used as multifunctional façade  
Claddings on the south façade. Non exposed façades are covered by non active elements having the same appearance.

#### Solar product

Manufacturer: Energie Solaire SA -Z.I. Falcon, CH-3960 Sierre, Switzerland

Website: [www.energie-solaire.com](http://www.energie-solaire.com)

Module size: 236 x 86 x 0.5 [cm] / solar effective : 1.93 m<sup>2</sup>

System size/ energy output: 4576 m<sup>2</sup>; 288'000 kWh/year; 97% Solar fraction

#### Integration achievements

Collector used as multifunctional construction element	+
Field position and dimension	+
Visible materials	+
Surface texture	+
Surface colour	+
Module shape & size	+
Joining	+





## GLAZED FLAT PLATE COLLECTORS

### School building in Geis, Switzerland, 1996, architects Gsell und Tobler

#### Building facts

Climate type: Continental

Building size: N.A.

Application: Collectors integration considered at the very early design phase. Collector dimensions (fixed) defining the modular rhythm of the whole south façade, of the spaces behind it, and of the roof structure.

#### Solar product

Manufacturer: Ernst Schweizer AG, CH-8908 Hedingen, Switzerland

Website: [www.schweizer-metallbau.ch](http://www.schweizer-metallbau.ch)

Module size: 2081 x 1223 [mm]

System size: 63m<sup>2</sup> (the collector field occupies the entire parapet area)

Energy output: 20'000 kWh / year

#### Integration achievements

Collector used as multifunctional construction element	+
Field position and dimension	+
Visible materials	+
Surface texture	+
Surface colour	+
Module shape & size	+
Jointing	+ / -

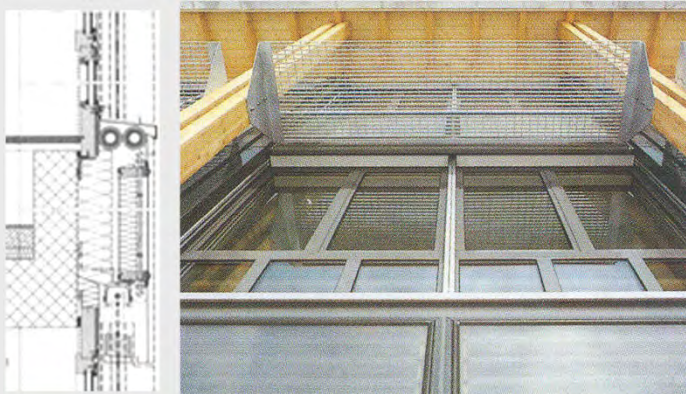



## GLAZED FLAT PLATE COLLECTORS

### Family house in Nenzing, Austria, architects Achammer & Partner OEG

#### Building facts

Climate type: Continental

Building size: about 160 m<sup>2</sup>

Application: Collectors integrated in the south façade and combined with a dark blue façade cladding (Eternit type) so as to create a homogeneous envelope appearance. Use of horizontal aluminium jointing to increase the homogeneity, and make the system less noticeable.

#### Solar product

Manufacturer: AKS DOMA Solartechnik, 6822 Satteins, Austria

Website: [www.aksdoma.com](http://www.aksdoma.com)

Module type: Doma flex holz (3 different custom dimensions)

System size: 12 m<sup>2</sup> (the collector field occupies the entire parapet area)

Energy output: solar fraction of about 90%

#### Integration achievements

Collector used as multifunctional construction element	+
Field position and dimension	+
Visible materials	+ / -
Surface texture	+ / -
Surface colour	+
Module shape & size	+
Jointing	+

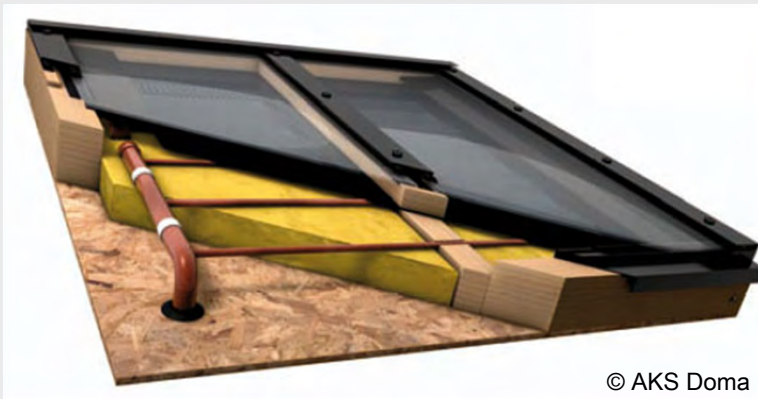



## GLAZED FLAT PLATE COLLECTORS

### Row dwelling Storelva-Tromsø, Norway, 2007-2008, arch Steinsvik

#### Building facts

Climate type: Sub arctic

Building size: 96m<sup>2</sup> x 7 residential units, i.e. 672m<sup>2</sup>

Energetic standard: Passive House label (1th labelled building in Norway)

Application: 7 glazed solar field of 5m<sup>2</sup> integrated in the south façade.

The wooden envelope cladding underlines the solar modules, making them easily recognizable and strongly characterizing the whole architecture. The facade composition is perfectly balanced and the building highly inspiring.

#### Solar product

Manufacturer: Viessmann – 35108 Allendorf (D) - [www.viessmann.com](http://www.viessmann.com)

Module size: 2056 x 2380[mm] (module Vitosol 100)

System size: 35 m<sup>2</sup> coupled with a heat pump (collectors contribute to domestic hot water pre-heating mainly during spring, summer, autumn )

#### Integration achievements

Collector used as multifunctional construction element	+/-
Field position and dimension	+
Visible materials	+
Surface texture	+
Surface colour	+
Module shape & size	+
Jointing	+







## EVACUATED TUBES COLLECTORS

### Sunny Wood, multiple family house, Zurich 2002, arch Beat Kämpfen

#### Building facts

Climate type: Continental

Building size: 200m<sup>2</sup> x 6 residential units, i.e. 1200m<sup>2</sup>

Energetic standard: Minergie Passive label

Application: The 18 vacuum collectors modules, composed of nine tubes each, are 90 cm height and ensure the double function of solar thermal heat production (space heating +DHW) and standard balcony parapets .

#### Solar product

Manufacturer: SWISSPIPE Balkone by Schwizer energie AG (Switzerland)

Website: [www.schweizer-energie.ch](http://www.schweizer-energie.ch)

Module size: nine tubes modules of 90 x 292 cm

System size: 39m<sup>2</sup> + 6 x 1400l.tanks

Solar fraction: about 90% of floor heating + domestic hot water

#### Integration achievements

Collector used as multifunctional construction element	+
Field position and dimension	+
Visible materials	+
Surface texture	+
Surface colour	+
Module shape & size	+
Jointing	+

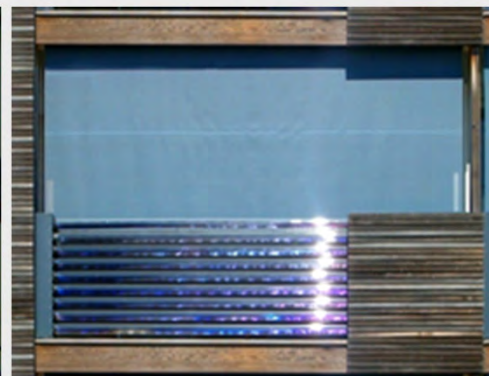



### 3.A.4. FORMAL FLEXIBILITY OF EXISTING PRODUCTS

A good knowledge of existing products and the formal flexibility they offer in module shape/size, surface textures, colours and jointing greatly helps selecting, designing and integrating the solar system within the architectural context of the building. The formal flexibility of the three main ST technologies is analysed [3-A.1].

#### · *Glazed flat plate collectors*

*Dimensions:* These collectors are generally rectangular boxes of about 1 x 2 m, proposed in a very few standard dimensions by most manufacturers.



Fig. 3.A.21 Typical standard glazed flat plate collectors installed over the roofing, as purely technical add-on

Some advanced producers offer collectors in a quite wide range of dimensions and even shapes, but they are still the exception. These manufacturers generally use absorbers made of series of thin, cut to length strips, replacing the less flexible single metal plate of standard absorbers (figs. 3.A.22-24).

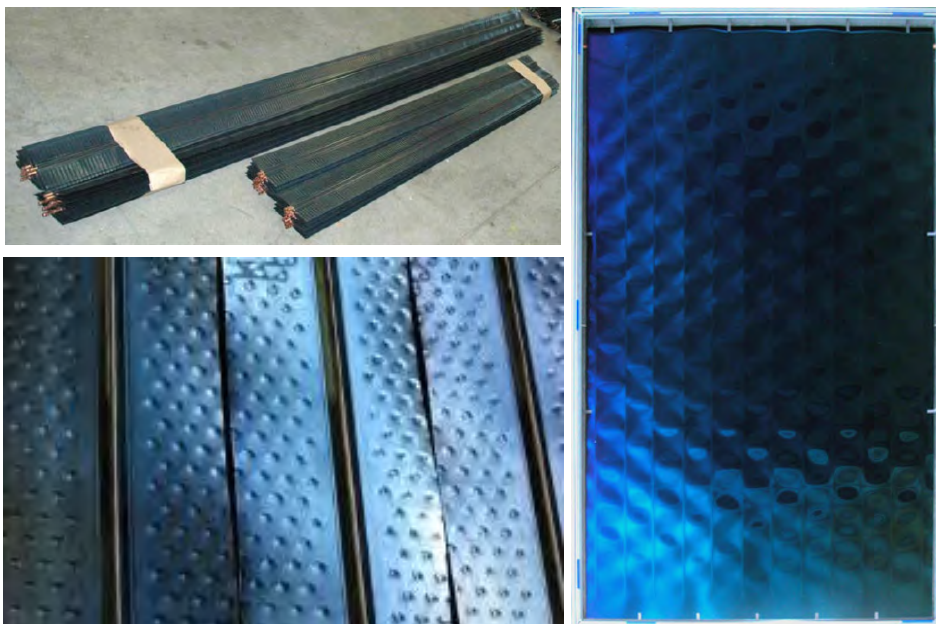

Fig. 3.A.22 and 3.A.23: cut to length strip absorbers (12 cm. wide) Fig. 3.A.24: Single metal plate absorber.

**Glass:** The front covers are made of extra white glass proposed in different varieties, from perfectly smooth untreated surfaces to lightly diffusing or strongly textured finishing (pyramids). Unfortunately, most of the time only one choice is available from each manufacturer.

**Colour and texture:** As the absorber is visible through the cover glass, its colour and texture are important. To be efficient, the absorbers need to be very dark, with colour palette revolving around true black, with some variations into dark blue, rarely green or brown. The absorber texture is often marked by the welding of the hydraulic system, in ways varying from product to product. As each manufacturer essentially uses only one kind of absorber, usually there is no colour and texture choice (fig. 3.A.25).

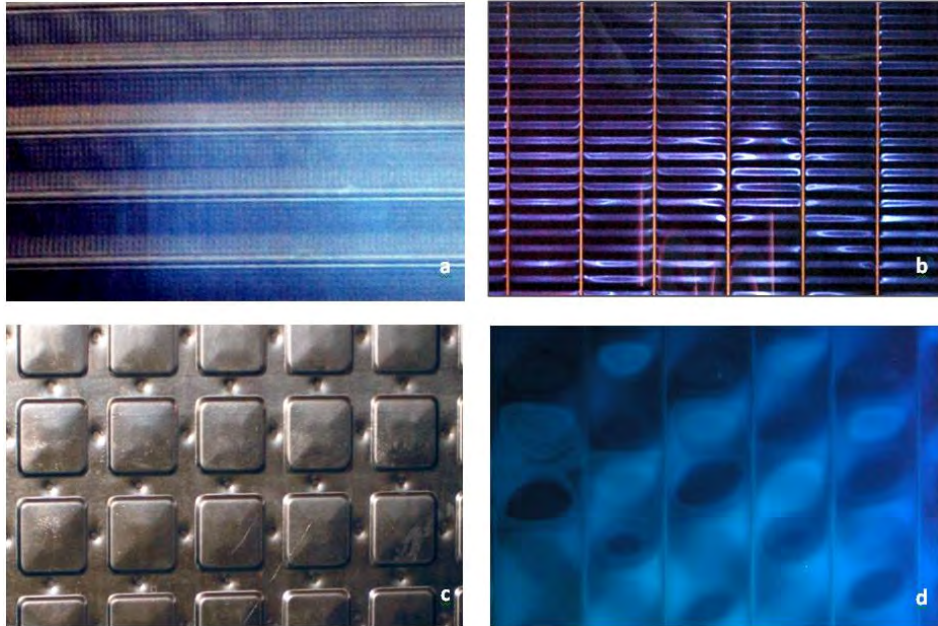

Fig. 3.A.25: appearance of different types of absorber metal plates

**Jointing:** the joint for the cover glass is usually made of black EPDM rubber and can be sometimes hidden by a metal plate which can also cover the module to module jointing.

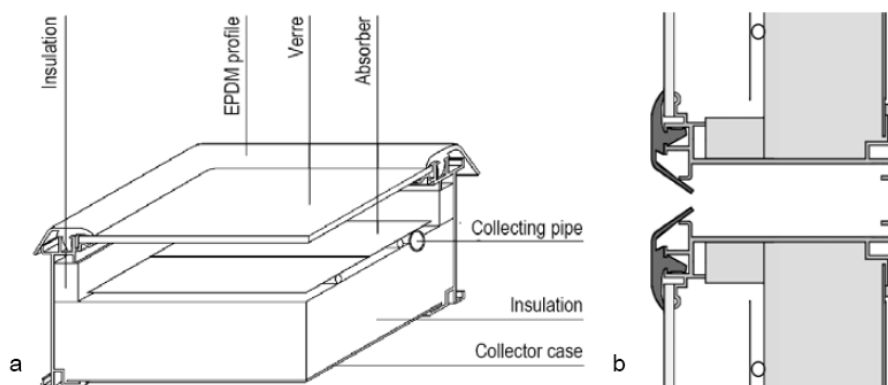

Fig. 3.A.26 -a: ready to mount collector modules using EPDM rubber jointing to fix the glazing to the collector case

Fig A.26-b: Module to module jointing resulting from mounting side to side already assembled modules with EPDM jointing.

- *Unglazed flat plate collectors:*

Very few products are available in this technology, consisting mainly of two types:

- standard products optimised for efficiency and cost
- collectors associated to an existing building envelope system. These collectors are already fully adapted to the envelope system (size, shape, colour, texture), but limited to this context (eg. Rheinzink: Quick Step SolarThermie; Energie Solaire SA: Solar Roof).

*Absorber:* In both cases the absorber metal sheet is the only visible layer. As external layer, it has to resist shocks and weather, requiring a thicker metal sheet than glazed collectors. Apart from this difference, all considerations about colours and textures are identical. Sometimes inexpensive “dummy” elements of the same appearance are available for architectural composition (eg. Solar Roof).

*Insulation:* often the back insulation can be combined with the building insulation, and products can be found non-insulated with a very low thickness (approx 1cm).

*Joining:* In absence of casing and rubber joint, the possibilities are very similar to those of standard metal cladding (negative jointing, metal profile), or included into the concept when associated with a building product.

(see examples of innovative unglazed collectors products in the next section)

- *Evacuated tube collectors:*

*Element :* the basic element is a single tube with a diameter of 7-15 cm, containing an absorber in the center (black plate or black tube)

*Collector size:* evacuated tube collectors are composed of several tubes arranged and connected in parallel. The standard arrangement is a field of 10-15 glass tubes with manifold ducts at top and bottom. The tubes' length is fixed for most products (1-1.5 m) while the number of paralleled tubes is sometimes flexible.

*Appearance:* The dominant appearance is a glass tubes field, with inside black absorbers more or less visible, depending on manufacturers. A reflector sheet might be present at the back of the field. No additional insulation is needed.

(see following examples of innovative evacuated tube products in next section)

### 3.A.5 INNOVATIVE PRODUCTS

The following sheets present a collection of innovative market products able to offer to designers enhanced building integration possibilities. The integrability of products is evaluated according to a set of criteria derived from the considerations presented in chapter 2 of this document. The three grades evaluation scale varies from “-” for a negative appreciation, to “+” for a positive appreciation, with +/- considered as neutral.





**winkler VarioSol E collectors system**

**Winkler Solar GmbH**  
 Räterweg 17 A-6800 Feldkirch  
 solar@winklersolar.com  
 http://www.winklersolar.com

Winkler VarioSol is a glazed flat plate system conceived for façades and is characterized by a very high level of freedom both in size and shape of the modules: 38 different standard formats up to 24 m<sup>2</sup> are proposed, and almost any customized shape can be provided at a reasonable extra cost. This flexibility comes from the absorber structure made of strips of small width and length cut to measure up to 5 m. Collectors are produced on order so that individual details, like jointing, can be made to measure.

No dummies elements are available, and no choice is given on absorber colour/texture.

**ST "Integrability" characteristics**

Multifunctional element	+
Shape & size flexibility	+
Glazing: surface texture choice	+/-
Absorber: surface texture choice	-
Absorber colour choice	-
Jointing options	+
Availability of dummies	-
Complete construction system	+/-

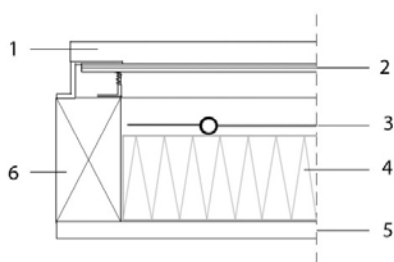

- Element list and Nomenclature**
- 1 Cover rail
  - 2 Glazing
  - 3 Absorber
  - 4 Thermal insulation
  - 5 Back
  - 6 Frame

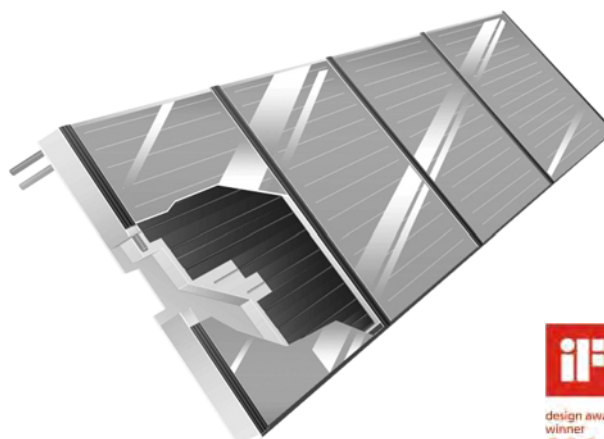







**AKS DOMA Solartechnik AKS Doma Flex**

**AKS Doma Solartechnik**

Sonnenstrasse 1, 6822 Satteins, Austria

office@aksdoma.com

http://www.aksdoma.com

AKS Doma Flex system is a glazed flat plate system conceived for façades, and is characterized by a very high level of freedom in both size and shape of the modules: 30 different standard formats up to 20 m<sup>2</sup> are offered. Customized module shapes and dimensions can also be easily provided. Like for Winkler collectors, this flexibility comes from the absorber structure made of strips of small width and length cut to measure up to 6 m. Joining of different colours are available. No dummy elements are available, and no choice is given on absorber colour/texture.

**ST "Integrability" characteristics**

Multifunctional element	+
Shape & size flexibility	+
Glazing: surface texture choice	-
Absorber: surface texture choice	-
Absorber colour choice	-
Joining options	+
Availability of dummies	-
Complete construction system	+/-

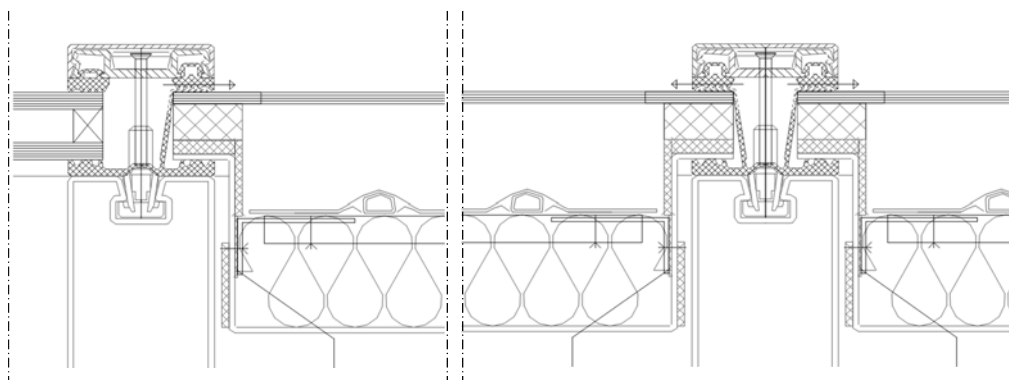





### H+S Panel 38

H+S Solar GmbH

Feldstrasse 51, CH-9455 Rebstein

ch.hutter@hssolar.ch

<http://www.hssolar.ch> [www.hsserviceag.ch](http://www.hsserviceag.ch)

H+S Solar GmbH - H+S Pa is a glazed flat plate system conceived for façades, and is characterized by its reduced thickness (38mm) that eases the integration into the building skin.

The glazing is glued by the glass manufacturer itself to the collector structure with the same technique used to glue double glazing. Being air tight, the gap is filled with argon gas which helps reduce heat losses.

The gluing of the glazing allows the use of any jointing system providing a new level of freedom in the field of glazed flat plates. The reduced thickness and the gluing technique allow the mounting also on triple glazing window frames.

No freedom is allowed in module shape and size, nor in absorber or glazing surface texture/colour .

#### ST "Integrability" characteristics

Multifunctional element	+
Shape & size flexibility	-
Glazing: surface texture choice	+/-
Absorber: surface texture choice	-
Absorber colour choice	-
Jointing options	+
Availability of dummies	-
Complete construction system	+/-

38 mm

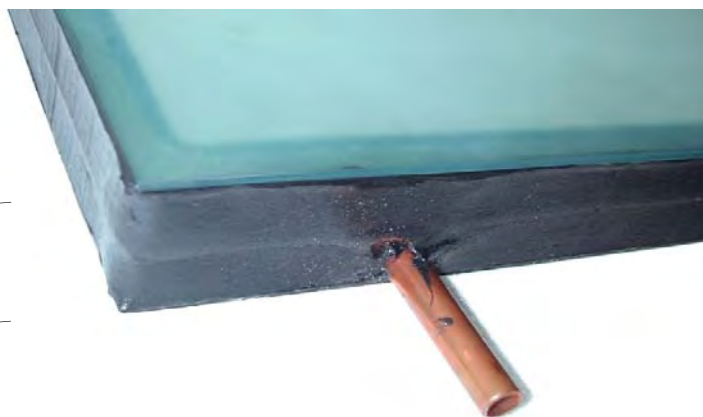
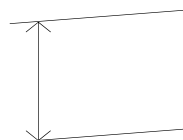





**STAHLBAU LAMPARTER** Solar Thermal Glass Façade

Heinrich Lamparter Stahlbau GmbH & Co. KG

D-34060 Kassel

info@stahlbau-lamparter.de

www.stahl-und-glas.de

The product recently proposed by Heinrich Lamparter Stahlbau GmbH & Co. KG is derived from the triple glazing technology. The possibility to mount the collector using standard triple glazing framing systems makes it particularly suitable for the integration into glazed facades; furthermore the very reduced thickness makes it a good option in building renovation. Thanks to the use of a roll bond absorber, the collector offers a very large dimensional freedom. Like for all the other glazed flat plate systems on the market, no dummy elements are available today.

**ST "Integrability" characteristics**

Multifunctional element	+
Shape & size flexibility	+
Glazing: surface texture choice	+/-
Absorber: surface texture choice	+/-
Absorber colour choice	-
Jointing options	+
Availability of dummies	-
Complete construction system	+

1. first glass layer, 4 mm
2. space holder for the incorporation of the absorber
3. temperature-proof edge-bond
4. absorber with absorbing layer
5. second glass layer, 4 mm enamelled
6. temperature-proof edge-bond
7. space holder
8. argon gas-filling
9. third glass layer, 4mm
10. pressure compensation

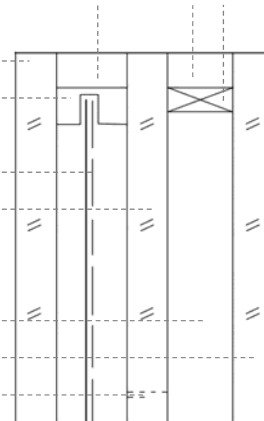





CH 1530 Payerne  
 info@eternit.ch; http://www.eternit.ch;  
 http://www.soltop.ch; http://www.suntechnics.ch

This SOLAR FORCE system has been designed by Eternit (façade and roof manufacturer) together with SOLTOP (glaze flat plate solar thermal collectors) and SunTechnics Fabrisolar AG (photovoltaic modules).

The active solar modules (both thermal and photovoltaics) are conceived to be integrated into the Eternit INTEGRAL PLAN roof covering system.

The module size and the jointing of the active solar modules are developed to match the ones of the standard Eternit INTEGRAL PLAN shingles.

The colour and surface texture of the thermal modules are intended to match the dark grey and mat aspect of the shingles .

**ST "Integrability" characteristics**

Multifunctional element	+
Shape & size flexibility	-
Glazing: surface texture choice	+/-
Absorber: surface texture choice	-
Absorber colour choice	+/-
Jointing options	+/-
Availability of dummies	+
Complete construction system	+

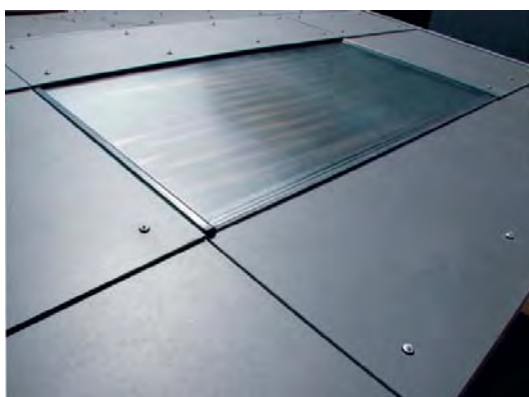
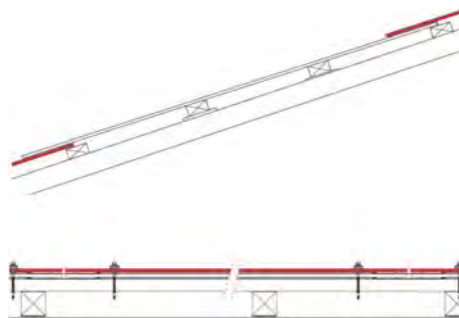
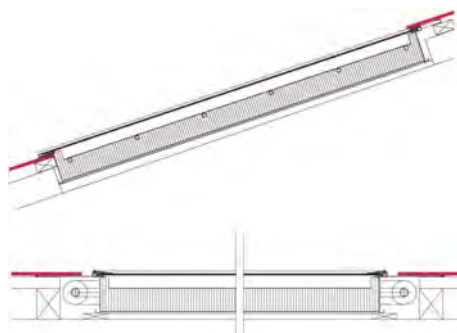

QUICKSOL compact system (solar thermal - SOLTOP)



Photovoltaic INTEGRAL PLAN (SunTechnics Fabrisolar AG)







## S\*SOLAR Prisma

S-solar AB  
[www.ssolar.com](http://www.ssolar.com)

Prisma is a glazed flat plate system for solar heating or cooling. Prisma is a thin (70 mm excluding glass) construction with high efficiency that is designed to be integrated in the conventional façades. The dimensions of the façade element is adjusted after the façade proportions as well as the glass thickness in relation to building codes. The collector has a maximum size of 1200 x 2200 mm behind the glass. Prisma has a colorprint at the edges of the glass that can be customized in color, as well as the surface of the glass can be in milky white as well as transparent. The product has a very high efficiency due to very low heatlosses and is Solar Keymark Certified. Weight excluding glass is 5 kg, standard glass thickness is 6-10 mm. Prisma can be integrated in traditional mounting systems.

### ST "Integrability" characteristics

Multifunctional element	+
Shape & size flexibility	+
Glazing: surface texture choice	+/-
Absorber: surface texture choice	-
Absorber colour choice	-
Jointing options	+
Availability of dummies	-
Complete construction system	+

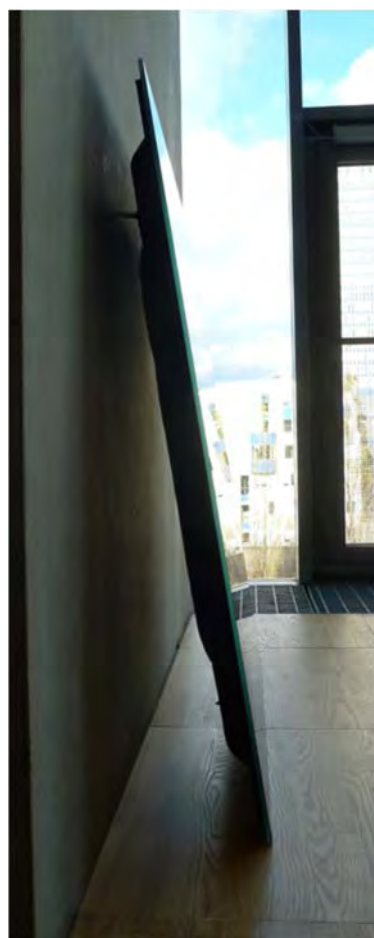





**s•SOLAR Prisma**

**S-solar AB, Sunstrip AB**  
 Finspång, Sweden  
[www.ssolar.com](http://www.ssolar.com)

Orbit is a solar thermal collector for roofconstructions, substituting other cladding in an efficient construction, as well as freestanding or rooflighting structures (possible angle inclinations 14–90°). It is a classic collector with a more elegant jointingstructure. Certified Solar Keymark. Only one dimension is available (2100 mm x 1200 mm x 85-100 mm).

**ST "Integrability" characteristics**

Multifunctional element	+
Shape & size flexibility	-
Glazing: surface texture choice	-
Absorber: surface texture choice	-
Absorber colour choice	-
Jointing options	+
Availability of dummies	-
Complete construction system	+/-

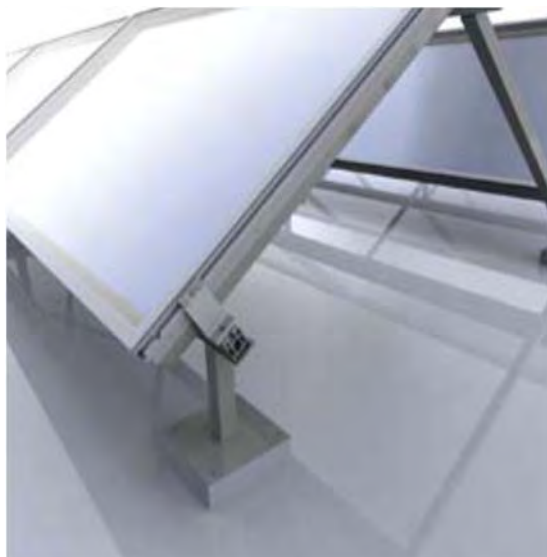
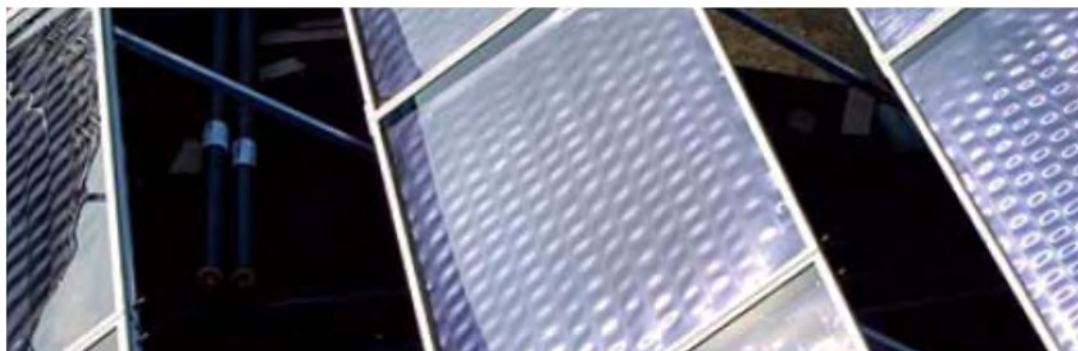





**IMERYS Thermal Tiles**  
*Terre Cuite*

IMERYS Terre Cuite, Service Solaire

info@eternit.ch  
http://www.eternit.ch;  
http://www.soltop.ch; http://www.suntechnics.ch

The Imerys Thermal Tiles are glazed solar thermal collectors compatible with a range of ceramic tiles produced by the group. With its reduced size and thickness, this rectangular module integrates well in new and existing pitched roofs, as it uses the same roof structure as the tiles. Existing joints are adapted to curved and slightly curved tiles. The technology to allow flat tile jointing is under development. A similar and size compatible Tile with photovoltaics cells completes the offer for solar energy use. The collector is directly screwed onto the battens, and lateral jointing with the ceramic or photovoltaic tiles is made without need for any additional element.

**ST "Integrability" characteristics**

Multifunctional element	+
Shape & size flexibility	+/-
Glazing: surface texture choice	-
Absorber: surface texture choice	-
Absorber colour choice	-
Jointing options	+
Availability of dummies	+/-
Complete construction system	+

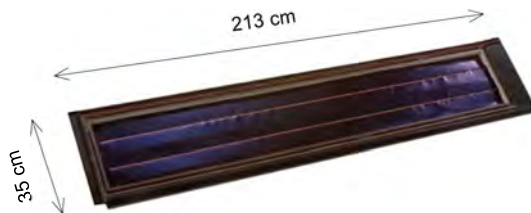

Tile surface: 0,75 m<sup>2</sup>  
Absorber area: 0,55 m<sup>2</sup>



*Connection can be made from the upper part of the roof and underneath the roof structure.*

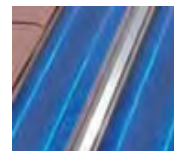

*Compatible joints, no need for additional sealers.*







 SolTech Energy **SolTech Sigma**

SolTech Energy Sweden AB  
<http://soltechenergy.se>

The SolTech Sigma is a specially developed tile with low iron (more transparent) for active energy roofs. The tiles are laid on the roof and battens much in the same way as traditional concrete tiles, and the absorbers developed for quick mantling between the battens on insulation fitted between the battens. Works for re-roofing as well as new roofs. The tile is a Double-S profiled tile very similar to traditional concrete tiles used in the Nordic and other countries. There is only one size. The flexibility lays within the solar thermal systems modular size adjusted for traditional roofing, where the visible tiles meets ends in tin, customized by traditional handycraftmen.

**ST "Integrability" characteristics**

Multifunctional element	+
Shape & size flexibility	+
Glazing: surface texture choice	-
Absorber: surface texture choice	-
Absorber colour choice	-
Jointing options	+/-
Availability of dummies	+
Complete construction system	+

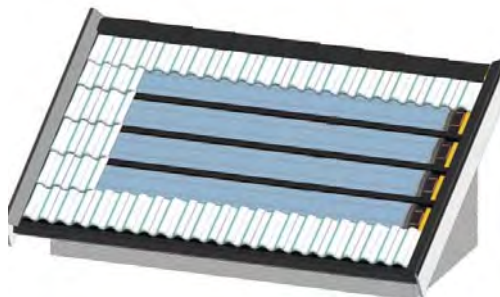







## **aventa solar** Polymer flat plate solar collector

**AventaSolar - Aventa AS**

Trondheimsveien 436 a, N - 0962 OSLO, Norway

epost@aventa.no

www.aventa.no

The AVENTASOLAR collector is a glazed flat plate collector with the absorber and the glazing made of polymeric materials. The collector consists of two twin-wall sheets of high temperature resistant plastics, fixed in an aluminium frame. The solar radiation is converted to heat in the absorber sheet.

The collector is conceived as a standard building element that can replace other types of roof or facade coverings, with a weight of only 8 kg/m<sup>2</sup> while filled (6.5 kg/ m<sup>2</sup> without water). The building modules come in 4 different lengths up to 6 metres and a fixed width of 60cm. No dummies are available, and no flexibility is allowed in the texture and colour of the absorber and the polymeric glazing. Yet the grey, mat appearance of the collector surface can be interesting for façade applications.

### ST "Integrability" characteristics

Multifunctional element	+
Shape & size flexibility	+/-
Glazing: surface texture choice	+/-
Absorber: surface texture choice	+/-
Absorber colour choice	-
Jointing options	+/-
Availability of dummies	-
Complete construction system	+/-

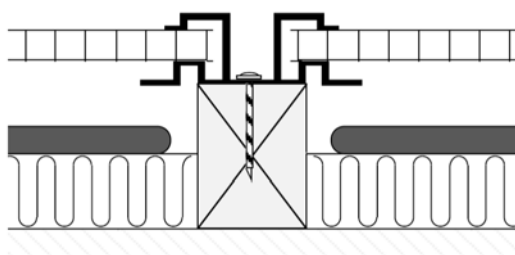
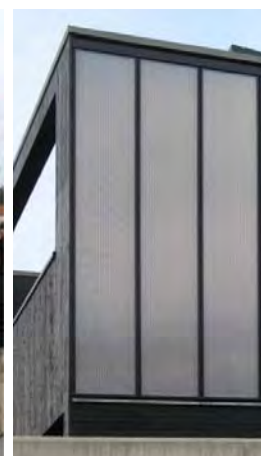

Figure 2 Cross section of the solar collector







## RobinSun Solar Thermal Glass

### Robin Sun

Rue fossé des tailleurs, 2 – 67000 Strasbourg, France

robinsun@robinsun.com

<http://www.robinsun.com>

The RobinSun Solar Thermal Glass is a multifunctional double-glazed insulating glass unit (I.G.U.) integrating a semi-transparent solar thermal collector. This innovative collector contributes to natural lighting and building insulation and is conceived for integration into fixed façade window frames (wood, aluminium, pvc). The energy collected by the solar absorber integrated into the glass is transferred by water circulation into storage and the hydraulic connections are innovatively fitted into the frames. The collector is available in four standard dimensions, and custom sizes are possible on demand. No dummies are available, and no flexibility is offered regarding the colour of the absorber.

### ST "Integrability" characteristics

Multifunctional element	+
Shape & size flexibility	+
Glazing: surface texture choice	+
Absorber: surface texture choice	-
Absorber colour choice	+/-
Joining options	+
Availability of dummies	-
Complete construction system	+/-

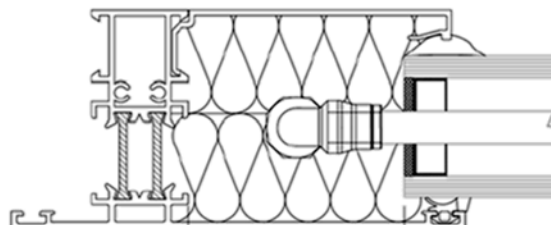
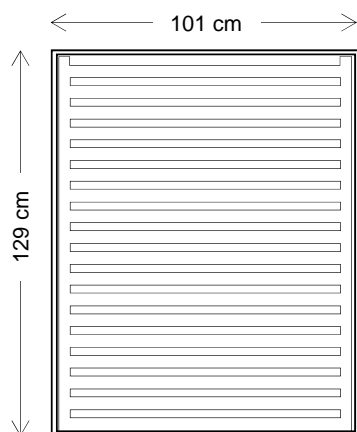





**EPFL** **SWISS INSO** **LESO coloured glazing**

**EPFL/LESO - SwissInso**

Ecole Polytechnique Fédérale de Lausanne - Laboratoire d'Énergie Solaire  
 Station 18, CH-1015 Lausanne (Switzerland)  
<http://leso.epfl.ch/>  
[www.swissinso.com](http://www.swissinso.com)

Glazed flat plate thermal collectors are generally characterized by the black appearance of the solar absorber, with surface imperfections and welding points appearing through the glazing. The LESO Coloured Glazing are conceived to tackle these issues and are an alternative to transparent collector glazing. They can be cut to measure and can be mounted on any solar thermal collector system.

Through specifically designed selective filters, these colored glazing hide completely the collector absorber placed behind, while letting most of solar energy pass through (with less than 10 % energy loss). Several colors and surface finishes can be produced.

The same glazing can be used both as collector glazing in front of solar absorbers and as facade cladding on the non exposed areas of the building envelope, making possible to have a homogeneous building appearance of active and non-active parts.

**ST "Integrability" characteristics**

Multifunctional element	+
Shape & size flexibility	+
Glazing: surface texture choice	+
Absorber: surface texture choice	n.r.
Absorber colour choice	n.r.
Jointing options	+
Availability of dummies	+
Complete construction system	+

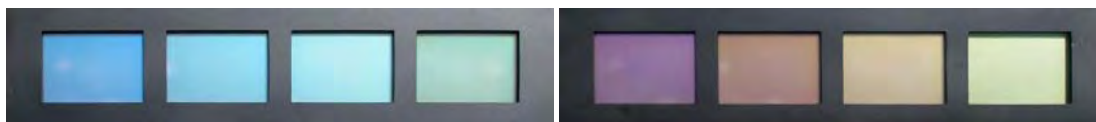
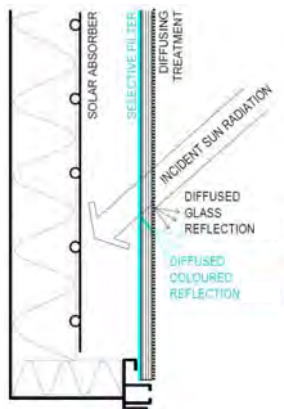





## Solar Roof

**Energie Solaire SA**

Z.I. Ile Falcon 3960 Sierre / Valais / Suisse

info@energie-solaire.com

http://www.energie-solaire.com

The Energie Solaire Solar Roof is an unglazed solar thermal system characterized by its absorber: a flat fully irrigated heat exchanger made of two structured stainless steel sheets.

The collector is conceived as a multifunctional element for roof covering, but can also be used on façades.

Its peculiar structure allows the integration on all types of roof profiles, even curved ones.

No flexibility is offered for surface geometry and colour, nor for module dimensions. Nevertheless the double sheet structure of the absorber allows the use of non active elements (made of the external metal sheet only) of any shape and size to complete the façade/roof covering system, and the selective black surface allow very good energetics performances for an unglazed system.

### ST "Integrability" characteristics

Multifunctional element	+
Shape & size flexibility	+/-
Glazing: surface texture choice	n.r.
Absorber: surface texture choice	-
Absorber colour choice	-
Jointing options	+/-
Availability of dummies	+
Complete construction system	+

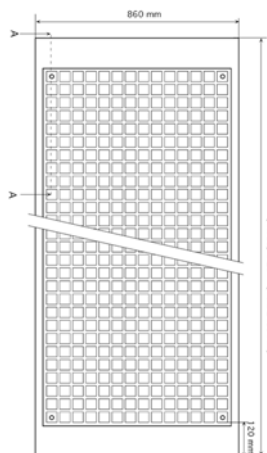

#### SOLAR ABSORBERS:



Double structured metal sheet filled with liquid (fixed dimensions)

#### NON ACTIVE ELEMENTS (ROOF COVERING/FACADE CLADDING):



External metal sheet only (any dimensions)









## RHEINZINK® QUICK STEP Solar Thermie

RHEINZINK (SCHWEIZ) AG

Täferstrasse 18

5405 Baden-Dättwil

info@rheinzink.ch

http://www.rheinzink.ch

QUICK STEP Solar Thermie is an innovative, low efficiency, unglazed system for roofs, produced by the roof and façade manufacturer Rheinzink. The active modules, available in two grey shades, have been developed to be integrated into the standard Rheinzink QUICK STEP roof covering system, so that active modules look exactly like the traditional non active ones: field positioning and dimensioning is not anymore an issue. The system is conceived as a proper active roof system (recently also proposed for façade use).

Even though its energy performances are low due to the light colour of the absorber and the lack of selective treatment, the building integration potential is very high and shows the importance of involving building manufacturer in the development of new products for building integration.

### ST "Integrability" characteristics

Multifunctional element	+
Shape & size flexibility	+/-
Glazing: surface texture choice	n.r.
Absorber: surface texture choice	+
Absorber colour choice	+/-
Jointing options	+
Availability of dummies	+
Complete construction system	+



Abb. 7: Unverglaster Sonnenkollektor QUICK STEP®-SolarThermie

- 1 Wärmedämmung
- 2 Schutzkassette, unterseitig
- 3 RHEINZINK®-Oberfläche
- 4 Systemtray inkl. Systembefestiger
- 5 Fluidträger
- 6 Sammelrohr mit Steckverbindung
- 7 flexibler Edelstahlschlauch





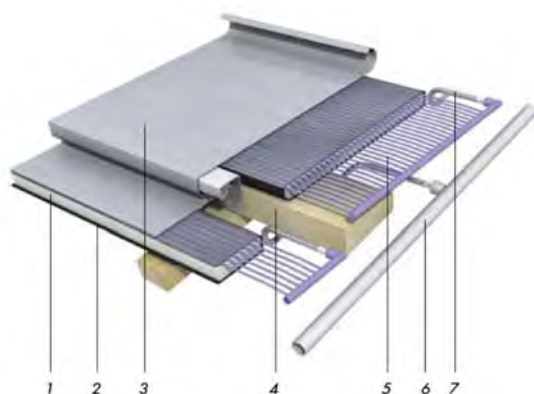

## **KME** TECU® Solar System

### **KME Italy**

Via Corradino d'Ascanio, 4 – 20142 Milano, Italy

tecusolarsystem@kme.com

<http://www.kme.com/tecu-solarsystem>

The TECU Solar System is a roof covering in copper in which copper collectors are integrated. The modules make use of solar radiation to produce domestic hot water and to feed the heating system.

Under the absorbing surface is a copper serpentine pipe in which an antifreeze glycol liquid flows.

There is some flexibility for module dimensions and colour. The company proposes a standard dimension of 35 cm in width and a length of 2 m or 3m up a maximum of 5 m, but it is also possible to have tailored sizes. The product is available in the pre-oxidised and in the green pre-patinated surfaces.

Even if the energy performances are lower than black selective metal absorbers, this product can be very well integrated as roof covering and it interfaces perfectly with the TECU product range with a very good homogeneous result.

### ST "Integrability" characteristics

Multifunctional element	+
Shape & size flexibility	+
Glazing: surface texture choice	n.r.
Absorber: surface texture choice	+
Absorber colour choice	+
Jointing options	+
Availability of dummies	+
Complete construction system	+

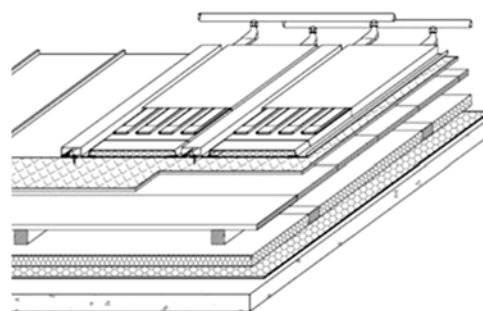





## ATMOVA Biberschwanz/Classic

### Atmova

Weidenstrasse, 50 - 4143 Dornach, Switzerland

info@atmova.ch

http://www.atmova.ch

The Atmova copper roof covering is an unglazed solar thermal system in the shape of traditional flat tiles, well suitable for historical buildings. Three different tile shapes are available, together with the corresponding dummies to complete the roof covering (i.e. the standard tiles).

Although the integration is excellent, the drawback of this product lies in the lower temperature and energy production compared to a classic unglazed flat plate collector, since there is no selective paint on the surface. It is then necessary to connect the solar thermal system to a heat pump if higher temperatures are needed.

### ST "Integrability" characteristics

Multifunctional element	+
Shape & size flexibility	+
Glazing: surface texture choice	n.r.
Absorber: surface texture choice	+
Absorber colour choice	+
Jointing options	+
Availability of dummies	+
Complete construction system	+

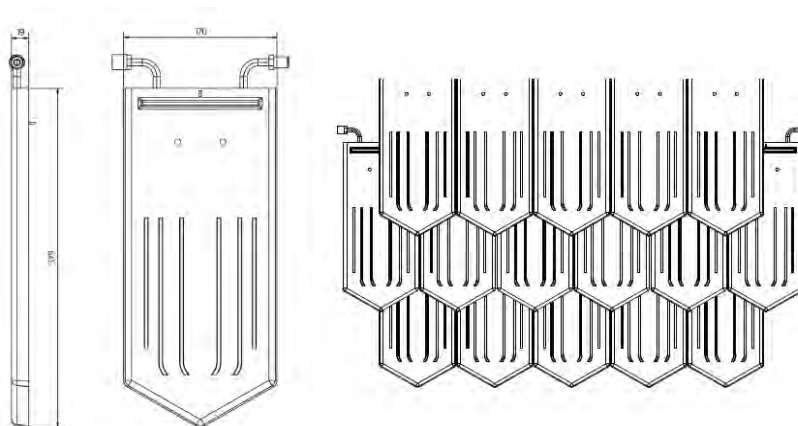





## **SolarWall** Solar Air Heating System

**SolarWall**  
 Conserval Engineering, Inc  
 200 Wildcat Road, Toronto, Ontario M3J 2N5  
 info@solarwall.com  
 http://www.solarwall.com

The Solar Wall unglazed air system is a perfect multifunctional façade system.

Its appearance is very similar to the one of profiled metal sheet for façade cladding. Its low extra cost allows using the same profile both on exposed and non exposed envelope area, solving the issue of dummy elements.

The colour palette is as large as any standard façade cladding palette. It comprises both high and low efficiency shades, leaving to the architect the choice of using a more or less efficient colour according to building and context specificities.

### ST "Integrability" characteristics

Multifunctional element	+
Shape & size flexibility	+
Glazing: surface texture choice	n.r.
Absorber: surface texture choice	+/-
Absorber colour choice	+
Jointing options	+
Availability of dummies	+
Complete construction system	+

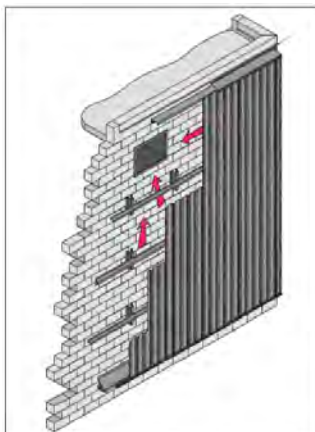

SolarWall® panels mounted over masonry wall

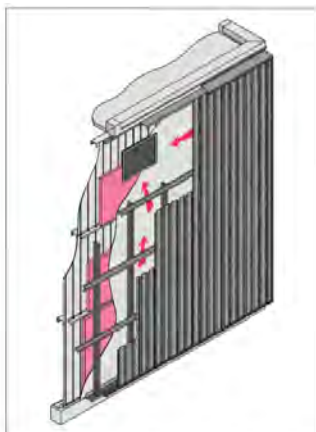

SolarWall® panels mounted over metal wall

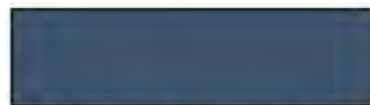

Heron Blue Absorptivity 0.9 - VW18079



Tile Red Absorptivity 0.89 - VW18085



Cambridge White Absorptivity 0.38 - VW18181









## Slate Roofs

HeliPower

www.heliopower.dk

Slate Roofs is a very innovative unglazed system with low efficiency (20-30% of solar irradiation) but high integrability. It is a quick and easy system covered by traditional slate roofs, perfect for retrofit as well as new constructions. Roof angles can vary 20-90 degrees, so it is for facades as well as for roofs. Heating can be used for under floor heating and pool water.

### ST "Integrability" characteristics

Multifunctional element	+
Shape & size flexibility	+
Glazing: surface texture choice	n.r.
Absorber: surface texture choice	+/-
Absorber colour choice	+/-
Jointing options	+
Availability of dummies	+/-
Complete construction system	+







## Asfalt Roofs

HeliPower

www.heliopower.dk

Asfalt Roofs is a innovative unglazed system with low efficiency (25% of solar irradiation) , quick and easy system covered by traditional asphalt roofs. Roof angles can vary 0-60 degrees, so it can be used for facades as well as for roofs. Heating can be used for under floor heating and pool water.

### ST "Integrability" characteristics

Multifunctional element	+
Shape & size flexibility	+
Glazing: surface texture choice	n.r.
Absorber: surface texture choice	+/-
Absorber colour choice	+/-
Jointing options	+
Availability of dummies	+/-
Complete construction system	+

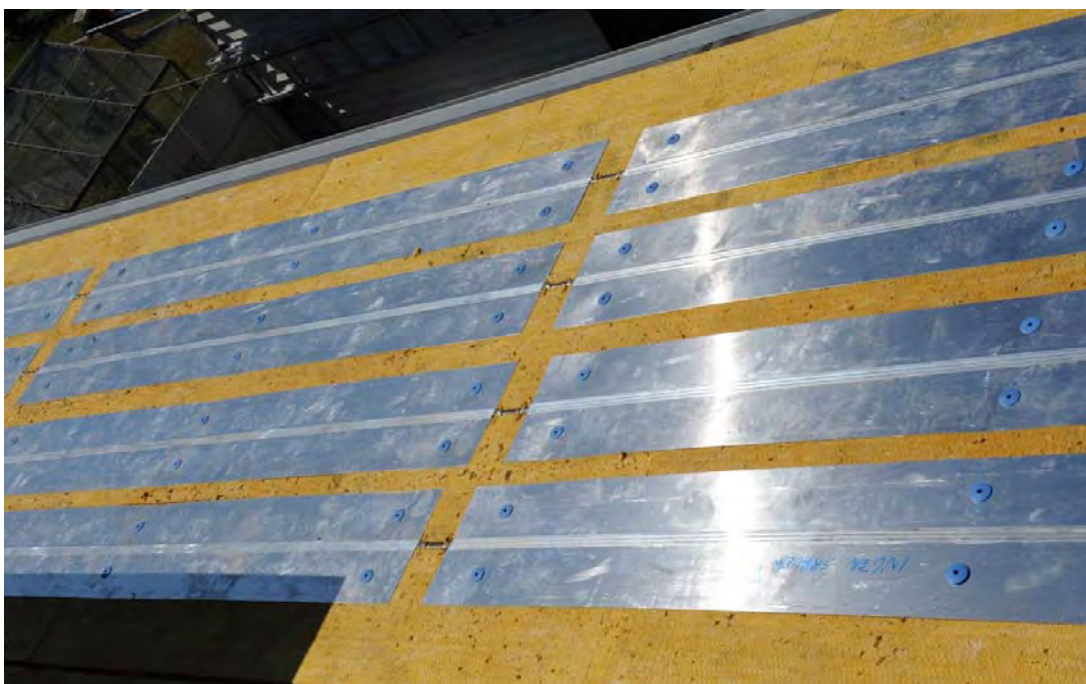
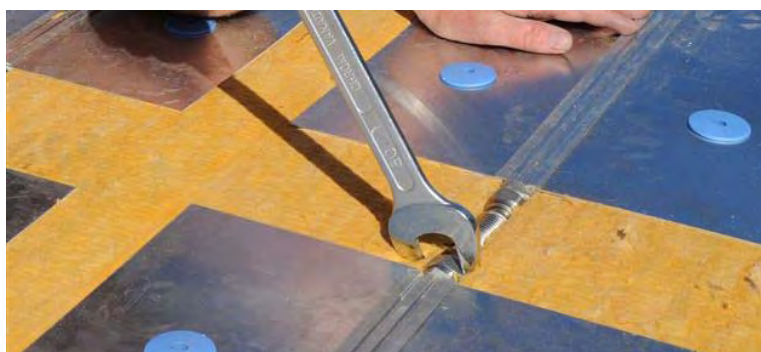





## S•SOLAR *white* Protected Strip

S-solar AB  
 Finspång, Sweden  
[www.ssolar.com](http://www.ssolar.com)

Protected Strip is a solar thermal product to be used between glass in the nordic regions, and without glass in southern hemisphere. It can also be used as an activated indoor solar shading in buildings without solarglass in retrofit, atrium etc. The protected strip has a high flexibility in lengths from 600 to 7000 mm. There are two widths; 143 or 122 mm or 70 mm. The product has a high efficiency surface coating method that can be applied on one or two sides, colours can be customized within certain frames to an extra cost. Protected strip can be integrated in the indoor bearing structure.

### ST "Integrability" characteristics

Multifunctional element	+
Shape & size flexibility	+
Glazing: surface texture choice	n.r.
Absorber: surface texture choice	+
Absorber colour choice	+
Jointing options	+
Availability of dummies	-
Complete construction system	+

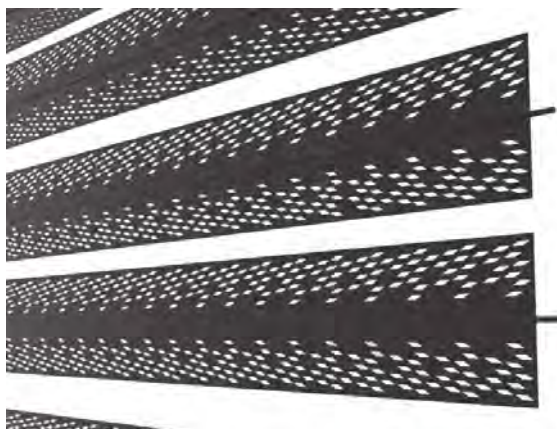

Protected strip, illustrations White arkitekter AB.





## SWISSPIPE Balkone

Schweizer energie AG

Im Chnübträchi 36 CH-8197 Rafz

<http://www.schweizer-energie.ch/>

Schweizer energie SWISSPIPE Balkone is an evacuated tubes system conceived as a multifunctional element for building façades. Starting from the peculiar vacuum collectors module structure made of parallel tubes, the manufacturer has developed a multifunctional balcony fence collector. The flexibility allowed in module size and jointing make this system a good option for the integration of evacuated tubes in building façades.

### ST "Integrability" characteristics

Multifunctional element	+
Shape & size flexibility	+
Glazing: surface texture choice	-
Absorber: surface texture choice	-
Absorber colour choice	-
Jointing options	+
Availability of dummies	-
Complete construction system	+/-

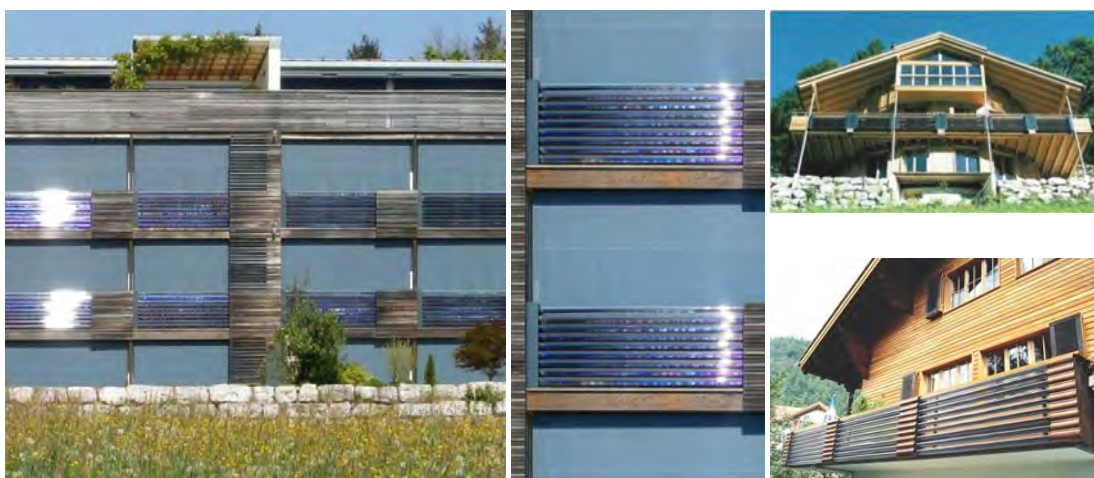
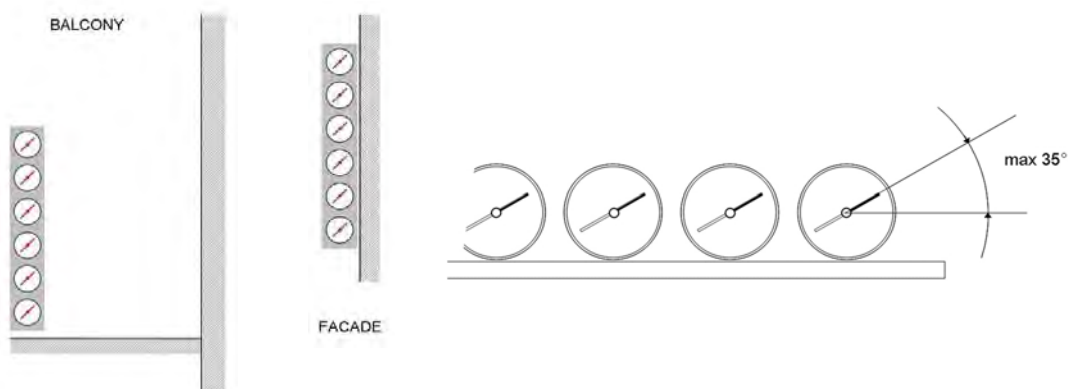







**CPC Office/System WICONA, Facade collector \***

Dipl.-Ing. Tina Volzrung

Universität Stuttgart-Institut für Baukonstruktion 2

<http://www.uni-stuttgart.de/ibk2>

solar collectors: Schott-Rohrglas

<http://www.schott.com>

This system integrates evacuated tube collectors (made by the manufacturer Schott-Rohrglas) into a global glazed façade concept targeted for office buildings. The collectors are multifunctional: they produce solar thermal heat and cool (solar cooling), and work as sun shading offering a partial protection against direct sun radiation over office glazing, while letting day light into the building.

*\* The system has been developed in close cooperation with several industrial partners (Hydro Building Systems WICONA, Frener & Reifer Metallbau, Ritter Energie und Umwelttechnik, Metallbau Früh) and research partners (technical University of Munich) and will be soon available on the market.*

**ST "Integrability" characteristics**

Multifunctional element	+
Shape & size flexibility	+/-
Glazing: surface texture choice	-
Absorber: surface texture choice	-
Absorber colour choice	-
Joining options	+
Availability of dummies	-
Complete construction system	+/-

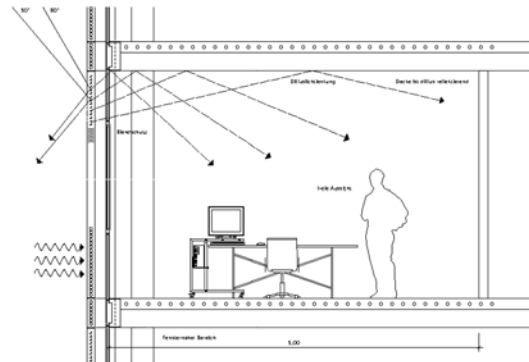
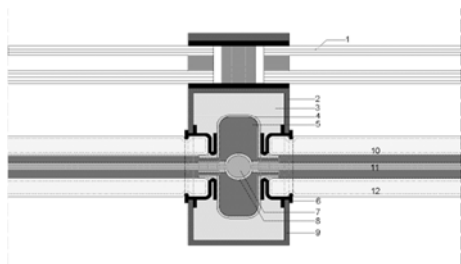



## References and further reading:

- [3-A.1] MC Munari Probst, C Roecker, Architectural integration and design of solar thermal systems, PPUR -Routledge, Taylor&Francis, 2011
- [3-A.2] W.Weiss, Franz Mauthner, Solar Heat Worldwide, IEA Solar Heating and Cooling Programme, 2010.
- [3-A.3] SYSTÈMES SOLAIRES le journal des énergies renouvelables N° 197 – 2010 Baromètre solaire thermique –EurObserv’ER –mai 2010.
- [3-A.4] M. Santamuris Editor “Solar thermal technologies for building - the state of the art”, James and James, 2003.
- [3-A.5] A.M. Papadopoulos, Active solar heating and cooling for buildings, in Solar thermal technologies for building - the state of the art, James and James, 2003, M. Santamuris Editor.
- [3-A.6] W. Weiss Editor “Solar Heating systems for Houses - A design handbook for solar combisystem”-James and James 2003: Book prepared as an account of work done within the Task26”Solar Combisystem” of the IEA Solar Heating and Cooling Programme.
- [3-A.7] C. Philibert, Barriers to Technology Diffusion: The Case of Solar Thermal Technologies, International Energy Agency, Organisations for Economic and Development, 2006.
- [3-A.8] I. Bergmann “Facade integration of solar thermal collectors – A new opportunity for planners and architects”, in Renewable Energy World, June 2002.
- [3-A.9] Thomas Matiska and Borivoj Sourek, Facade Solar Collectors, in Solar Energy 80 (2006) 1443-1452
- [3-A.10] Munari Probst MC, Roecker C, Architectural integration of solar thermal system, in Detail Green 01/2010 pp.46-49.
- [3-A.11] Munari Probst MC. Architectural integration and design of solar thermal systems PhD thesis EPFL n. 4258, 2008.
- [3-A.12] IEA SHC Task 39 Projects database: <http://www.iea-shc.org/task39/projects/default.aspx>
- [3-A.13] IEA SHC Task 41, Report T.41.B.3a: Solar Design of Buildings for Architects: Review of Solar Design Tools, ed. Miljana Horvat and Maria Wall.



## PART B: PHOTOVOLTAIC TECHNOLOGIES

*Klaudia Farkas, Francesco Frontini, Laura Maturi, Christian Roecker,  
Alessandra Scognamiglio, Isa Zanetti*

*Contributors : Marja Lundgren, Maria Cristina Munari Probst,  
Kim Nagel, Alessia Giovanardi, Marja Edelman*

### 3B.1. INTRODUCTION

Photovoltaic technologies are playing an important role in the mitigation of Global Warming producing “renewable energy” through a silent and invisible process. Moreover, Building integrated PV (BIPV) or Building added PV (BAPV) systems can produce energy where it is needed and without covering extra surface or green field sites.

PV technologies have been used in building integration for 20 years, but up to recently, at a modest level. This is mainly due to architectural, conventional thinking, and legislation issues. The present situation is unfolding as a dramatic push to increase the renewable part of our energy supply through maximizing the PV use on the building skins, making architectural integration a key issue.

Photovoltaic modules, available as flat or flexible surfaces, realized with cells or laminates, can be integrated into every part of the building envelope and due to their features (size, flexibility, shape and appearance), are particularly suitable for being “designed”. In fact, these photovoltaic elements can be used together with materials that are common in architecture, such as glass or metal, in opaque as well as in semitransparent surfaces.

Many products specifically developed for building integration are being proposed. They simplify even more the integration work, offering architects the possibility to use PV as a “material” or building component in the design process.

Manufacturers can today provide the building sector with different interesting products, ready to be used by architects and planners. It is therefore necessary to inform architects, stakeholders and technicians on the capabilities, potential, specific applications, strengths and weaknesses of Photovoltaics in buildings.

The following information, complimented with an extensive amount of products and installation examples, is intended to offer the reader an enticing initiation into this important field of expertise.

### 3B.2. PHOTOVOLTAICS (PV)

Photovoltaics (PV) is a way of generating electrical power by converting solar radiation into direct current (DC) electricity through the use of semiconductor technologies through the photovoltaic effect.

Materials presently used for Photovoltaics, discussed thoroughly in the following sections, include monocrystalline silicon, polycrystalline silicon, amorphous silicon, cadmium telluride, and copper indium gallium selenide/sulphide. All these technologies differ both in terms of employed

material and structure and they consequently influence the efficiency of the energy conversion. The cell types can be grouped in three categories: the traditional crystalline silicon cells (wafer based), the thin-film cell (made from different semiconductor materials) and the nanotechnology based solar cells. This third group is now appearing in the market.

PV cells must be interconnected to form a PV module. PV modules combined with a set of additional application-dependent system components (e.g. inverters, batteries, electrical components, and mounting systems), form a PV system.

### 3B.2.1 PV Available technologies

- Wafer based crystalline silicon cells: Monocrystalline cells (sc-Si), Multicrystalline cells (mc-Si)

Solar cells made from crystalline silicon continue to account for about 85% of the cells used worldwide [3-B.26].

Crystalline silicon cells (C-Si) are subdivided in two main categories:

single crystalline (sc-Si)

multi-crystalline (mc-Si).

Crystalline silicon cells are typically produced in a complex manufacturing process. In the following sections/paragraphs a strong simplification in describing the production process will be made, to make clear what the main features of this technology are.

*Monocrystalline* cells are produced from silicon wafers; these wafers are extracted from a square block of single crystal silicon, by cutting slices of approximately 0.2 mm thick. This produces square cells of 100 to 150 mm sides with a homogeneous structure and a dark blue / blackish colour appearance.

For *multicrystalline* cells, the melted silicon is cast into square ingots where it solidifies into a multitude of crystals with different orientations (frost-like structure), which gives the cells their spotted and shiny surface (fig 3.B.1).



Fig. 3.B.1: mono and poly crystalline cells

To collect the electricity, very thin silver contacts are applied on the front of the cells, while a back contact is applied at the rear.  
Finally an anti-reflection coating is applied to enhance the light capture properties (fig. 2).

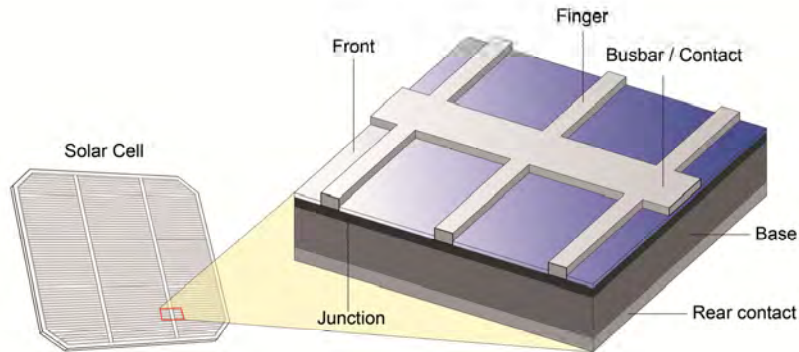

Fig. 3.B.2: crystalline cell structure (© SUPSI, ISAAC)

The efficiency of monocrystalline cells is currently the highest available on the market, ranging approximately from 17% to 22%, while multicrystalline cells are around 11% to 17%.  
To become a usable product, crystalline cells are electrically wired together and encapsulated into a substrate and a front covering material to create a solar module (fig. 3.B.3). The module can be provided with a frame, in order to improve its mechanical resistance. If it is kept unframed, the module is also called a “solar laminate”.

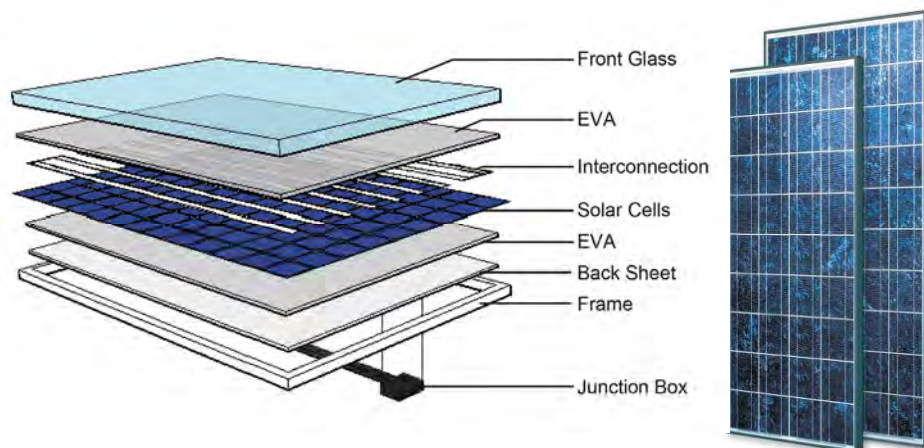

Fig. 3.B.3: Left: Module structure for crystalline cells (© SUPSI, ISAAC), Right: Polycrystalline modules

#### - Thin-film cells

Thin-film solar cells (also called “second generation” solar cells) and their contact are deposited directly on large area substrates, such as glass panels, stainless steel or polymers (square metre-sized and bigger) or foils (several hundred meters long).

Thin films can be seen as a microscopically thin layer of “disordered” photovoltaic material that gives the module surface a more homogeneous appearance.

With respect to wafer based crystalline technology, thin-film PV has a low-cost potential because its manufacture requires only a small amount of material, and is suited to fully integrate processing and high throughputs. Furthermore, the production process requires less energy than in the case of crystalline technology, since thin films are deposited at quite low temperatures (200 to 500°C vs about 1400°C for c-Si) and they can tolerate higher impurities than crystalline, thus needing less expensive purification of raw materials.

Thin-film solar cells are usually categorized according to the photovoltaic material used, the three main technologies being amorphous silicon (a-Si), Copper Indium Gallium Selenide (CIS or CIGS) and Cadmium Telluride (CdTe). The most common material is amorphous silicon. The production of amorphous or micromorphous silicon has undergone the most development (and this is why it is more diffuse than the other two thin film technologies) while the cadmium-telluride promises the lowest production costs and copper-indium-gallium diselenide achieves the highest conversion efficiencies (the new record value for flexible CIGS solar cells was reached in May 2011, by the EMPA laboratory, about 18.7% and nearly closes the "efficiency gap" to solar cells based on polycrystalline silicon wafers or CIGS thin film cells on glass).

Thin-film modules can be subdivided in three main categories, depending on the substrate that is used; in particular: glass, metal or polymeric material. In relation to the substrate material, thin film PV modules exist also in flexible and lightweight forms, as well as opaque or semitransparent.

Modules general surface appearances range from brown/orange to purple and black, with parallel lines more or less marked (fig. 3.B.4).

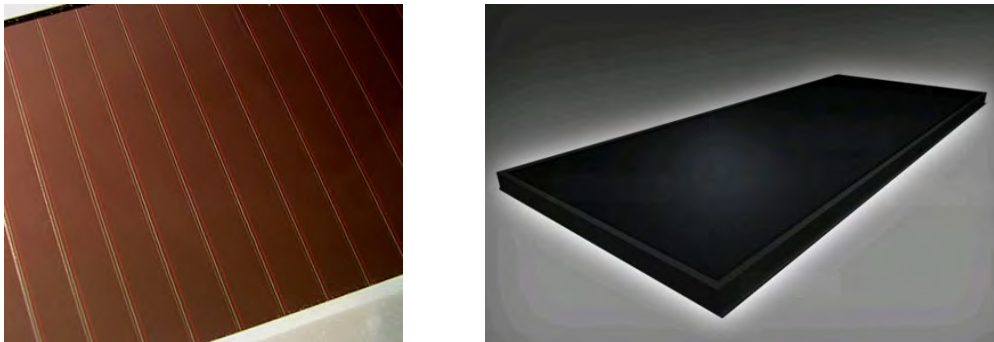

Fig. 3.B.4: amorphous silicon cell and module

While for standard amorphous silicon cells the efficiency lies among 4% to 8%, some manufacturers produce modules with combined cells (multijunctions), reaching efficiencies around 10%. CIGS cells can reach 12%.



- Emerging and novel PV technologies (third generation)

The category “Emerging” is used for those technologies which have passed the “proof-of-concept” phase, or could be considered as mid-term options compared with the two main established solar cell technologies (crystalline Si and thin-film solar cells). The category “Novel” will be used for developments and ideas which can lead to potentially disruptive technologies, but where there is not yet clarity on practically achievable conversion efficiencies or structure cost. Sometimes they are called also “third generation” cells.

Among the emerging PV technologies, organic solar cells play an important role. In fact, organic solar cells have already been subject of R&D for a long time, because they offer the prospect of very low cost active layer material, low-cost substrates, low energy input and easy up-scaling. For this technology the active layer, at least partially, consists of an organic dye and small, volatile organic molecules or polymers suitable for liquid processing.

Within ‘organic solar cells’, two technology branches can be distinguished. The first one is the hybrid approach, in which organic solar cells retain an inorganic component. The other one is the full-organic approach, with organic cells and organic substrates. The main challenges for both approaches are related to the efficiency and stability improvement, and the development of an adapted manufacturing technology.

Dye-sensitized solar cells (fig. 3.B.5) are an interesting example of the hybrid approach. They use an inorganic nano-structured substrate (titanium dioxide nano-particles), covered with a molecular dye that uses an artificial photosynthesis process to generate electricity.

New polymer cells are also appearing in the market. The main advantage of these cells is a much lower cost than crystalline or thin film ones, but due to their low efficiency and durability (up to now) they are not yet considered competitive in the market. Their efficiencies range from 4% up to 10%.

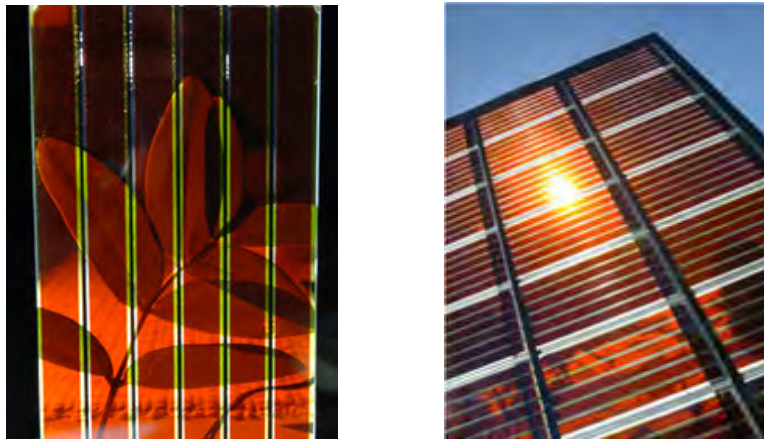

Fig. 3.B.5: dye-sensitized solar cell and module (© Dyesol)

Novel PV-technologies are characterised as high-efficiency approaches. Within this category, a distinction is made between approaches that tailor the properties of the active layer to match better the solar spectrum, and approaches that modify the incoming solar spectrum and function at the periphery of the active device, without fundamentally modifying the active layer properties [3-B.21].

### 3B.2.2 PV system

As the voltage and power of individual solar cells is inadequate for most applications, they are connected in series. As a consequence, the individual voltages of each cell are added together. The result is the formation of a PV module, the main element of a PV system.

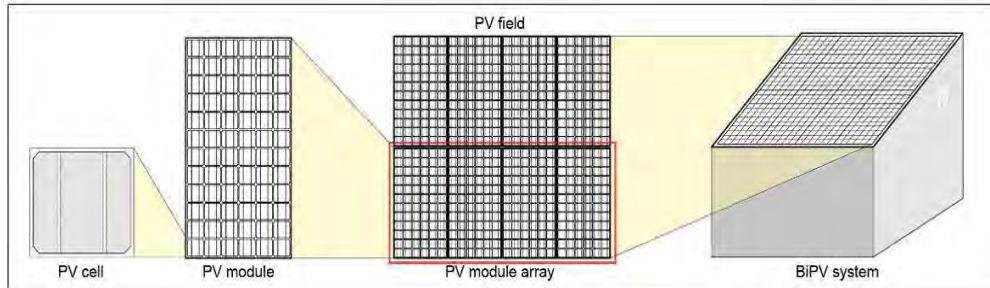

Fig. 3.B.6: From the solar cell to the BiPV system. (© SUPSI, ISAAC - www.bipv.ch)

The energy output from a single PV module is typically in the range of 180 - 250 Watts (also if small modules are available) in bright sunshine. A photovoltaic system is normally built up from a number of panels (an array), linked together to produce a more significant energy output. Before starting the discussion on the infrastructure and the components needed in order to use the produced electricity, we have to distinguish between stand alone and grid-connected systems.

- Stand alone systems are autonomous installation that supply one or more loads independently of any electricity grid, for example, systems for isolated houses, mountain huts (fig. 3.B.7) or isolate farms, far from urban settlements, without access to the public grid. For this reason, the solar energy produced by the PV plant must balance the energy required. In most cases, rechargeable batteries are used to store the energy surplus and are coupled with diesel-power generator or other additional energy generator (wind turbine for example). Stand alone system are also very common in thinly populated or poor regions of the world. Such installations can raise the living standard of the population.



Fig.3.B.7: Monte Rosa Hut, Monte Rosa-Zermatt, Switzerland (© Tonatiuh Ambrosetti, 2009, ETH Studio/SAC)

- Grid-connected systems

In order to avoid costly storage systems (like batteries) and to reduce the high losses, PV installations are connected to the electricity grid, when possible and use it as virtual storage. The PV modules produce direct current (DC) electricity, whereas the electricity supply (the grid) is

alternating current (AC). An electrical device called inverter is used to convert the DC to AC. The inverter is installed with switches on each side to allow it to be isolated for maintenance. The AC output from the solar installation is wired back to the main consumer unit in the building, where it should have a dedicated circuit breaker. A further switch gives the user a point of emergency isolation, and an energy meter is normally added to enable the visualization and control of the performance. The consumer unit is connected to the electricity grid via an export meter.

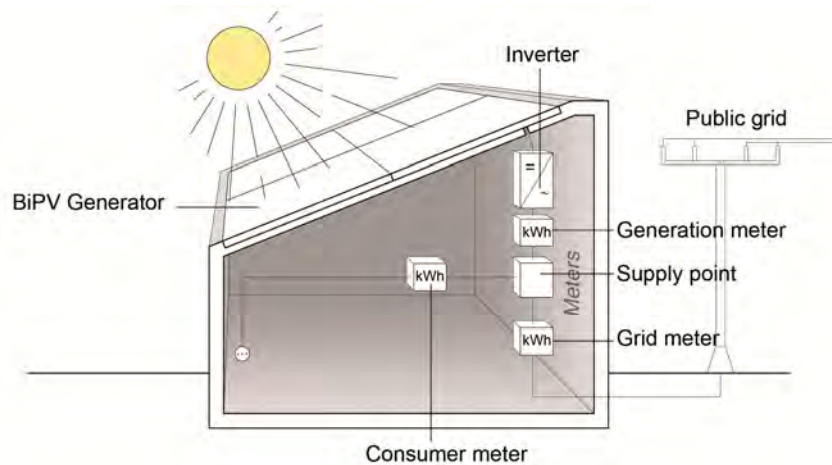

Fig. 3.B.8: Scheme of a common grid-connected roof integrated PV installation. (© SUPSI, ISAAC - [www.bipv.ch](http://www.bipv.ch))

Such an installation is termed “grid-tied” because the electricity supply for the building is met by a combination of solar energy and grid electricity. In this type of installation, the inverter must have an “anti-islanding” capability, which means that in the event of a power cut, the inverter automatically disconnects the solar installation, thus preventing electrification of the grid and protecting people who may be working to restore the electricity supply.

Of course, the electricity demand in the home varies minute by minute through the day as devices are switched on and off (lights, electrical equipment) or run in cycles (refrigerator, freezer). Solar electricity generation also varies minute by minute as the sun’s position changes in the sky and weather conditions change.

During periods where the electricity generation exceeds the energy consumption in the building, excess energy goes out into the electricity grid and can be used elsewhere. If the electricity consumption exceeds the solar generated electricity, then the shortage of energy is covered by the grid.

To summarize, we can say that a proportion of the generated electricity is exported, and a proportion used in the building.

As this document is not intended as a guide for the technician, a detailed commentary has not been provided concerning the description of the system technology.

### 3B.3 ENERGY OUTPUT – AREA – COST

#### 3B.3.1 Grid storage of electric energy

As discussed above, the energy generated by the PV cells can be stored in batteries in case of stand-alone systems or virtually stored in the electricity grid in case of grid-connected systems. In the first case, the actual energy production has to be balanced with the energy needs, while in the latter case (which is most common) the yearly energy production is the most important that is supplied to the grid.

Therefore, the PV systems are preferably placed in the building surfaces where the annual solar irradiation is maximized, when this is compatible with the architectural integration requirements.

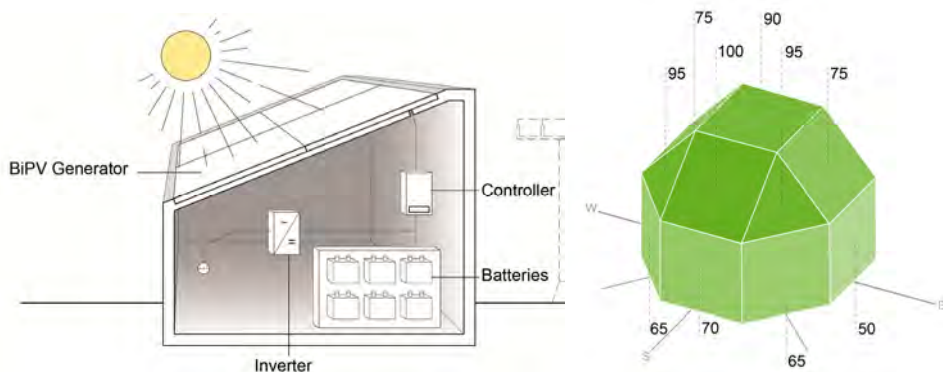

Fig. 3.B.9: Left – Stand alone system scheme. Right - Annual irradiation vs. orientation. (© SUPSI, ISAAC)

#### 3B.3.2 Energy yield

A rough estimation of the energy yield of a PV system can be assessed, in a first stage, through a simple calculation. This calculation is resumed in the following picture, where the main information needed is:

- 1) Location of the PV plant in order to estimate the Global irradiation on the horizontal surface "G" (many Irradiation maps are available which calculate the Global irradiance as function of the Latitude). The orientation of the modules gives then the effective radiation reaching the modules (orientation factor).
- 2) The adopted module technologies and the number of installed modules. With a simple multiplication of the cell efficiency (eff) and the modules area is possible to calculate the installed Power of the system.
- 3) The type of the installation: if the modules are integrated in the envelope and if the module are well ventilated. This information gives the Performance Ratio (PR) of the systems. As explained before, the PV modules efficiency strictly depends on the cell temperature.
- 4) The calculation can be done as follow:

$$FinalYield = G \left[ \frac{kWh}{m^2 a} \right] \cdot OrientationFactor [\%] \cdot Area \left[ m^2 \right] \cdot eff [\%] \cdot PR [\%]$$

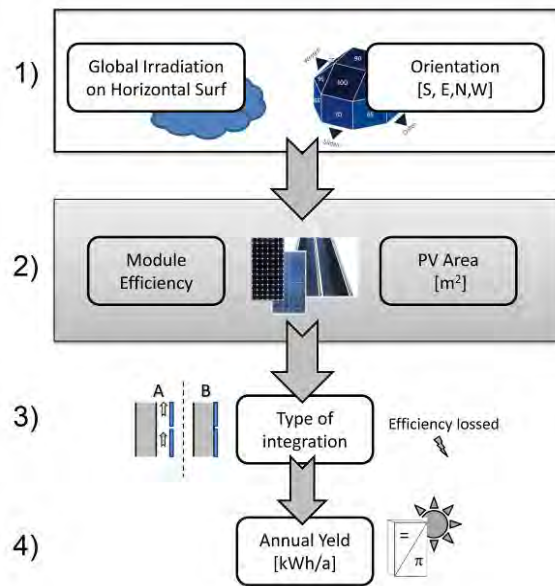

Figure 3.B.10: Example: 10kWp of roof integrated system is installed in Lugano (annual global horizontal irradiation = 1200 kWh/m<sup>2</sup> a) with monocrystalline e cells (cell eff 18%). The roof is south oriented and 30° tilted. The PV covered area is about 80m<sup>2</sup>. Good back ventilation of the modules and current maintenances are supposed (PR=80%). (© SUPSI, ISAAC - www.bipv.ch)

$$1200 \left[ \frac{\text{kWh}}{\text{m}^2 \text{a}} \right] \times 100\% \times 80 \left[ \text{m}^2 \right] \times 18\% \times 80\% = 13.824 \left[ \frac{\text{kWh}}{\text{a}} \right]$$

This procedure is helpful in the very early design phase. To have a more accurate value a web application (PVGIS) developed by the Joint Research Centre of the European Commission, available on-line for free (<http://re.jrc.ec.europa.eu/pvgis/>), can be used or a dynamic simulation software. PVGIS allows estimating PV electricity generation at any location in Europe, Africa, Mediterranean Basin and South-West Asia.

As explained before, to estimate the final Yield of a PV installation, different parameters and constraints must be taken into account. The correct control and design of these parameters is important to have an installation working properly. These parameters are described in the following text.

- Nominal power of the system

The nominal power is defined as the output power of a PV system under standard test conditions (STC): irradiance of 1000 W/m<sup>2</sup>, solar spectrum of AM 1.5 and module temperature at 25°C. However the working conditions of a PV module are very dependent on the location and the climate, and only seldom meet the STC, as shown in an example in Figure 11. Each photovoltaic technology performs differently when exposed to external conditions that differ to STC and produces a power that is noticeably different than the one sold from the manufacturer [3-B.2]

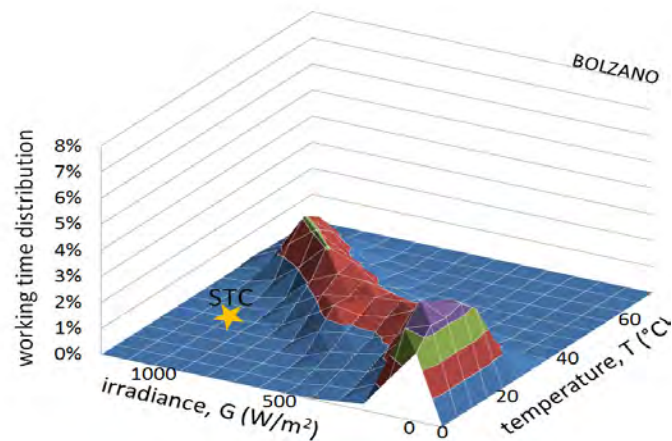

Figure 3.B.11: Working time distribution of a PV plant in Bolzano (Northern Italy) monitored for one year [3-B.2]. STC are rarely met.

- Orientation of the modules

For each geographic situation, there are different irradiation levels associated with different orientations. The yearly sum of global irradiation (defined as the sum of irradiation coming directly from the sun and diffuse irradiation coming from the sky and that has been reflected from the surrounding) is specific to the location and can be obtained from computer programs, databases, measurements, or from irradiance maps. To maximize the annual energy yield, the PV surfaces should be south-facing when situated north of the equator and north facing for countries south of the equator. A typical energy distribution for mid-Europe is shown in Fig 3.B.9. Main considerations are that for tilted roofs oriented S-E to S-W when the production is close to the maximum (above 95%) while for facades with the same orientations it drops to 65-70% (less for regions close to the equator).

The optimal value of inclination (tilt angle) for the PV system can be assessed by several PV software and depends on location and orientation (azimuth angle).

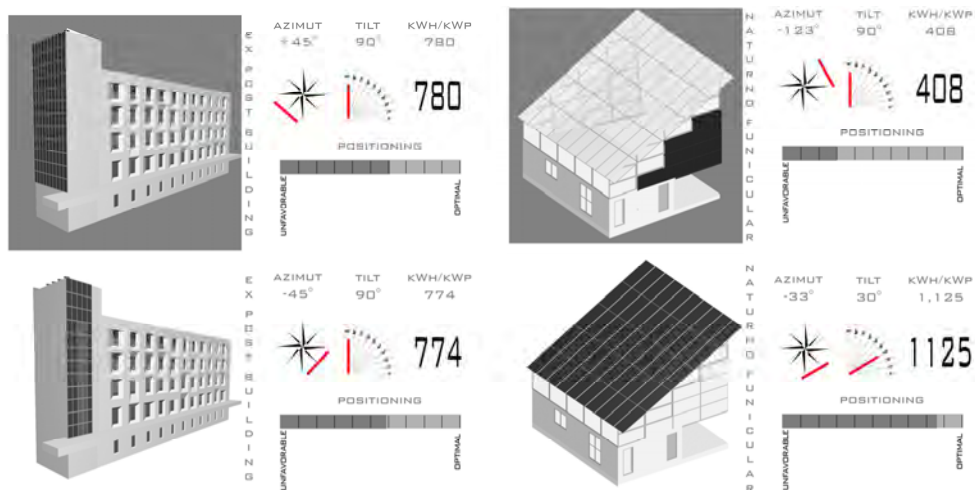

Figure 3.B.12: Example: for each partial generator of the three shown PV systems, situated in a latitude of 46 N and longitude 11 E (Central Europe), the specific annual yield is indicated (kWh/kWp). This value is closely related to the PV system positioning (azimuth and tilt angle). [Source: Eurac]

- Conditions at the location

Even partial shading can cause significant efficiency losses in the PV module output. Considering that within an array, the PV modules are connected in series, also the partial shading of one

single module of the array, even if it is equipped with bypass diodes, can affect the whole system performances.

In particular for buildings which are situated in an urban context it is often difficult to avoid this problem, because of the presence of mountains, trees, chimneys or other buildings.

Possible solutions which allow minimizing energy losses due to shading are:

- Correct string arrangement, which requires an accurate shading study. Each string should be simultaneously completely shaded or completely not shaded.
- Use of a large number of inverters or multistring inverters, having one MPP tracker for each string or one MPP for each module (module-inverters).
- Use of dummies, or fake modules, in the shaded areas.

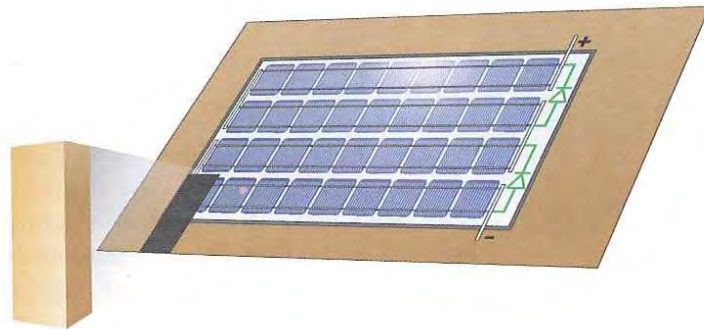

Figure 3.B.13: If a module lies in the shadow of a nearby object (such as chimney or an antenna), the entire current from the module would be determined by the shaded cell. The presence of bypass diodes could lower this loss effect. The same concept could be extended to an entire PV array. For further details refer to [3-B.12].

- Mounting situation and type of integration (ventilation and temperature coefficient).

A typical problem of BIPV systems is the power loss due to the temperature increase, because the modules are often installed next to another surface. In fact, a temperature increase of the module causes a decrease in the produced energy.

Different PV technologies have different temperature coefficients, which means that their efficiency can be more or less affected by the raised temperature, as shown in [3-B.14].

In order to maintain the temperature of the module as low as possible, it is important not to have the module in direct contact with another surface. Ventilation allows avoiding overheating of the module and can enhance the PV efficiency [3-B.4].

In fact, when PV modules are not ventilated, their temperatures can reach up to 70°C leading to a system efficiency reduction up to 25% [3-B.3]. For thin film modules the high working temperature can benefit the whole efficiency due to the "annealing effect" [3-B.5] Because of their lower temperature coefficients and the typical annealing effect, thin film amorphous silicon modules can potentially perform better than crystalline modules at high temperatures.

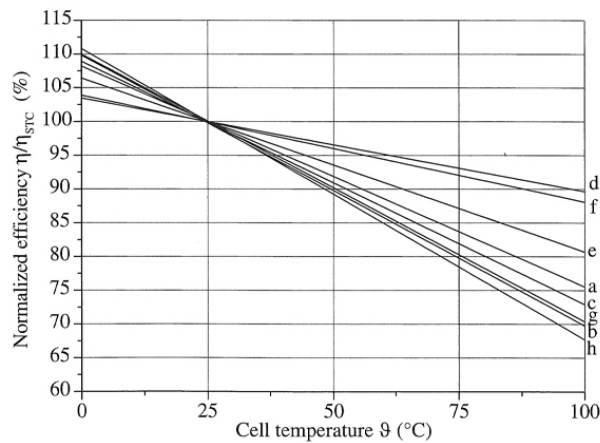

Figure 3.B.14: Representation of the effect of operating temperature  $T$  on the normalized value of the efficiency of typical solar modules, for various cell technologies: (a) high efficiency crystalline silicon; (b) monocrystalline silicon; (c) polycrystalline Silicon; (d) amorphous silicon; (e) "micromorph" tandem; (f) CdTe; (g)-(h) CIGS. Source: Arvind Shah [3-B.13].

- Inverter and system

Sizing the inverter for its required purpose is extremely important. If it is undersized, then it could shut off during operative conditions. If it is oversized, it will be much less efficient (due to the standing losses) and more costly to buy and run. Cables have also to be properly sized in order to minimize the energy losses.

The inverter must also be optimally matched to the I-V characteristic of the solar generator to ensure that the system operates under optimum conditions. In fact irradiance and temperature conditions keep varying during the day and thus the MPP (maximum power point) changes as well.

All these parameters have an influence on the final Performance Ratio (PR) of the Installation.

Common losses (the list is not exhaustive)	Mean losses
Glass Reflection losses	2 – 4 %
Deviation from STC	2 – 4 %
Temperature effect	3 – 6 %
Snow, dust, soiling on the modules	1 – 2 %
Shadows	≥ 0 %
Tolerance and mismatching	2 %
Inverter losses	≥ 5 %
Cables and line losses	1 – 2 %

- Ground reflection

In the design phase it is important to take into account the surfaces which surround the PV system. Their reflection capacity influences the amount of solar irradiation which hits the PV system, e.g. a white wall has diffuser Lambertian properties (it reflects the radiation in all the directions) or a mirror surface which direct the reflex in one particular direction (the radiation is reflected with an angle which is the supplemental of the hitting radiation).



### 3B.3.3 Space requirement

To produce the same amount of electric energy, very different amounts of envelope surfaces are needed, depending on technology efficiencies and area orientations. As the efficiencies can range from 5% to almost 20%, the space occupied by a system, for the same orientation, can vary up to a 4 to 1 proportion.

A useful formula to quickly estimate the space required ( $S_r$ ) to install 1kWp of PV, depending on the PV efficiency (eff), follows:

$$S_r [m^2] = 1/\text{eff}$$

Example: Considering a typical crystalline technology with an efficiency of 16%:  $S_r = 1/0,16 = 6,25 m^2$

This means that 1kWp of crystalline modules with efficiency of 16% require a space of 6,25 m<sup>2</sup>.

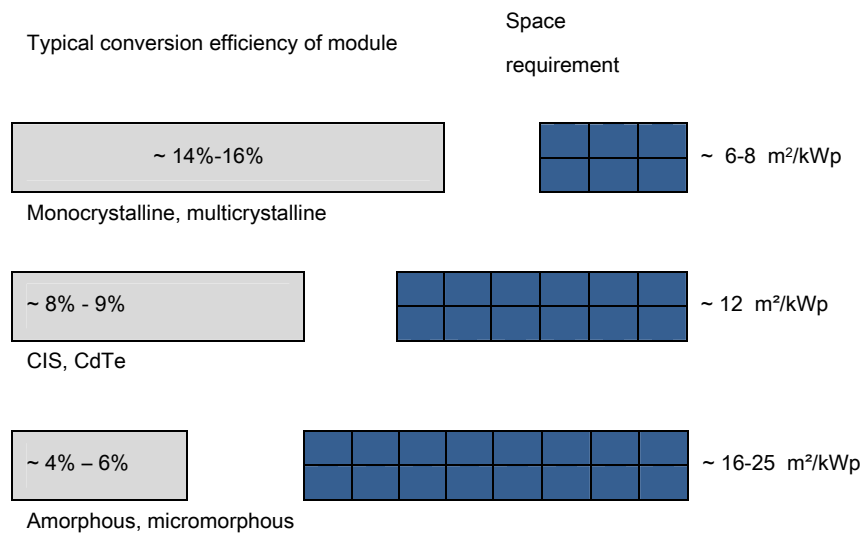

Fig. 3.B.15: How the efficiency of the modules influences the space required. (© SUPSI, ISAAC- [www.bipv.ch](http://www.bipv.ch))

### 3B.3.4 Costs

As all the PV technologies compete for the same market, producing electricity at the lowest cost, PV price depends directly on the Watt - peak capacity of a panel (€/Wp or US\$/Wp for example). "Watt Peak " is defined as the power a module can deliver under standard test conditions (solar irradiation 1000 W/m<sup>2</sup>, Air Mass of 1.5 and temperature 25°C). As the costs are not based on a module's area, but rather on its output, the system cost per kWp is comparable across cell types. An interesting consequence is that it is possible to cover different areas surfaces for a given price by using different technologies.

The cost of a photovoltaic system is composed of the PV modules price and of the BOS/Installation (Balance Of System) costs. This BOS/Installation includes the equipment such as the inverter, the switches, the cabling, the mounting system and the cost of installation. Modules typically represent 40-60 % of the total PV system cost.

Depending on the kind of product, from standard module to custom made, and from the country of origin, the price of the PV Watt peak can vary notably. Moreover, with the market extension and the increased production volume, all the prices are dropping slowly but steadily. Therefore, a price range of 1.5 to 5 €/Wp should be taken as just an indication of the present (2011) status.

Up to now, a standard exclusively dedicated to BIPV elements does not exist. For this reason today if we want to integrate a PV module in building we have both to comply with the electro-technical requirement as stated in the low voltage directive 2006/95/EC / or CENELEC standards,

related to the module itself, and with the Building products standards as provided by the European construction product directive CPD 89/106/EEC. To harmonise the standards, in 2010, CENELEC (European Committee for Electrotechnical Standardisation) started the project “prEN 50XXX: Photovoltaics in buildings” (CLC/TC 82 Scope) that is based on the Technical Committee for Electrotechnical Standardization, and whose aim is “to prepare European Standards for systems and components for photovoltaic conversion of solar energy into electrical energy and for all elements in the entire photovoltaic energy system” [3-B.15].

As they need solar radiation to work, photovoltaic modules must be placed on sun-exposed areas of the building envelope.

We can distinguish two ways of describing how Photovoltaics are integrated into the building.

The first one categorizes the integration possibilities according to an architectural, conceptual perspective, which looks at the building as a formal whole. In this case, Photovoltaics can be described with regard to the role that it plays in the concept of the envelope composition [3-B.22].

The second one categorizes the integration possibilities, according to a technological perspective, which looks at the way the PV component is integrated into the envelope systems. In this case Photovoltaics is mainly understood as PV components, which are able to substitute standard building elements (Building Integrated Photovoltaics - BIPV), or not (Building Added Photovoltaics - BAPV).

### 3B.4 INTEGRATION POSSIBILITIES IN THE BUILDING ENVELOPE

#### Photovoltaics and the conceptual integration into the envelope

Since Photovoltaics offer architects many design possibilities, like a common building material no categorization is exhaustive enough for describing all the ways to integrate Photovoltaics into the building concept. In order to simplify how Photovoltaics can be used in the envelope composition, six main categories have been defined:

1. added technical element
2. added elements with double function
3. free standing structure
4. part of surface composition
5. complete façade/roof surface
6. form optimized for solar energy
7. other (if not in 1-6. category)

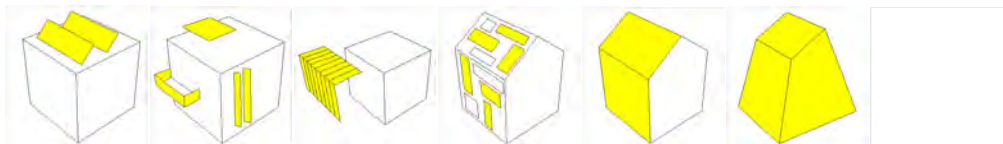

Fig. 3.B.16-A Conceptual integration typologies 1-7. (from left to right) used in IEA Task 41 – Subtask C

### Photovoltaics and the technological integration into the envelope

Photovoltaic modules can either be applied on top of the building skin (BAPV-Building Added Photovoltaics), or integrated into the envelope constructive system (BIPV-Building Integrated Photovoltaics).

In the first case photovoltaic modules are most commonly considered just as technical devices added to the building, even though there are constructively added systems that are integrated parts of the architectural concept. However, considering Photovoltaics as building components that are integral parts both of the constructive system and the overall architectural design leads usually to good architectural solutions, as several innovative projects demonstrate.

If we look at the two basic ways of using Photovoltaics in buildings (added on or BIPV), we can distinguish two main categories of PV products that can be used by architects. The first category, for BAPV require additional mounting systems; while the second one, for BIPV, with specially developed PV products, has the potential to meet all the building envelope requirements (such as mechanical resistance, thermal insulation, etc....). A variety of special PV components have been developed lately and is available on the market to match building integration needs [3-B.6].

Across these two perspectives, it is also possible to set up a topological-technological approach. The framework of this categorization is provided by the placement of the PV system in the building envelope (i. e. roof, façade, etc....), and then the way it is technologically integrated into the envelope system (BAPV or BIPV). The next paragraphs discuss the possibilities of using PV in the different parts of the building envelope, according to the topological-technological approach mentioned above.

### **3B4.1 PHOTOVOLTAICS AND THE BUILDING ENVELOPE**

In this paragraph the way Photovoltaics is used in the building envelope will be described. Three main categories are used: roofs, facades, and external devices. These categories will include different technological ways of using PV in the envelope, that lead to different choices of the PV component.

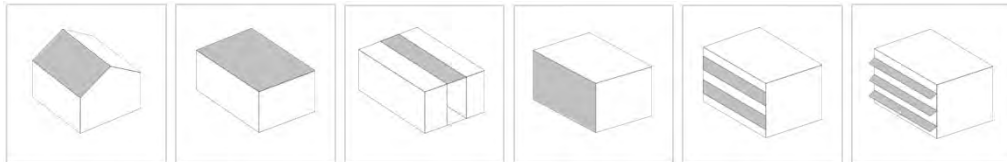

Fig.3.B.16-B.Integration typologies into the building envelope used in IEA Task 41 – Subtask A . From left to right: Tilted roof; Flat roof; Skylight; Facade cladding; Facade glazing; External device.

#### **3B4.1.A ROOFS**

A PV component can be added on the roof, can substitute the external layer of the roof system (i.e. PV as a cladding), or it can also substitute the whole technological sandwich (i.e. semitransparent glass-glass modules as skylights). Depending on the layer(s) the PV component substitutes, it has to meet different requirements that influence the choice of the most suitable PV component.

In the following, a general overview of the way PV can be used in roofs will be presented.

#### Opaque – Tilted roof

Building added PV systems have been very common on tilted roofs, especially in case of integration into existing buildings. Using this solution, there is a need for an additional mounting system and in most cases the reinforcement of the roof structure due to the additional loads.



Fig.3.B.17: crystalline roof systems: Solar tile © Ideassolar, Solar slate © Megaslate, Solar slate © Sunstyle Solaire



Fig. 3.B.18: thin film roof systems. From left to right: Solar tile © SRS Sole Power Tile, Solar shingle © Unisolar, solar laminate on metal roof © Rheinzink

The system mentioned above have been highly criticized for its aesthetics that urged the market to provide building integrated products replacing all types of traditional roof claddings. There are products both with crystalline and thin film technologies for roof tiles, shingles and slates that formally match with common roof products (fig3.B.17-18). Several metal roof system manufacturers (standing seam, click-roll-cap, corrugated sheets) developed their own PV products with the integration of thin film solar laminates (fig. 3.B.19). Moreover, there are also prefabricated roofing systems (insulated panels) with integrated thin film laminates available. Depending on the insulating features, these PV “sandwiches” can be suitable for any kind of building (i. e. industrial or residential).

It is somewhat surprising that many so called “first generation” BIPV products (i. e. roof tiles) proved to be unsustainable due to many reasons (especially cost-effectiveness)[3-B.23].

#### Opaque – Flat roof

In the case of flat opaque roofs, we can distinguish among PV systems with different tilt angles and PV systems on the same plane of the roof. The most common are added systems with rack supporting standard glass-Tedlar modules or to use specific tilted rack system for thin film laminates (fig. 3.B.19. right).



Fig.3.B.19: crystalline modules for flat roof. Left: standard module on rack mounting system, © Prosolar Right: special rack system for flexible laminate on stainless steel substrate, © Unisolar.

There is also a possibility to use crystalline modules with plastic substrates allowing a seamless integration on the roof with an adhesive backing (fig. 3.B.20). Thin film technologies also offer different flexible laminates, with plastic or stainless steel substrates, that can be easily mounted on flat roofs (fig. 3.B.20).

A recent trend for flat roof is using the waterproof membrane as a support on which flexible amorphous laminates are glued, providing a simple and economic integration possibility.



Fig. 3.B.20: integration of thin film laminates on flexible substrate in flat roof.

Left: Powerply monocrystalline module with plastic substrate © Lumeta, Right: Biohaus, Germany, plastic substrate, © Flexcell.

#### Semi-transparent – translucent roofs

The PV system can also become the complete roof covering, fulfilling all its functions. Most commonly semi-transparent crystalline or translucent thin film panels are used in skylights. (fig. 21). These solutions provide controlled day lighting for the interior, while simultaneously generating electricity. In the selection of the product it is important to consider the thermal (such as U-value and g-value) and day lighting features. Semi-transparent crystalline modules are sometimes custom-made. In this case it could happen that the architect has no technical information and data about the performance of the component from the manufacturer. A simulation or a special test or measurement should then be asked for [3-B.16], [3-B.17]. Standard translucent thin film modules, however, have more detailed datasheets with this information.

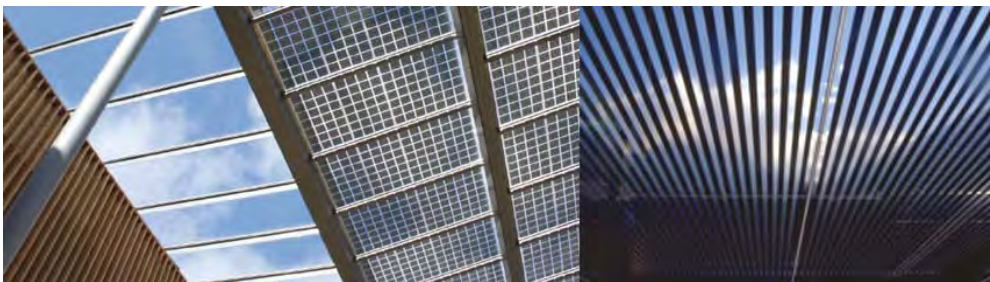

Fig. 3.B.21: semi-transparent skylights. Left: Community Center Ludesch, Austria, Herman Kaufmann: semi-transparent modules with crystalline cells © Kaufmann. Right: Würth Holding GmbH HQ: semi-transparent thin film modules © Würth Solar.

Transparent modules can also be used for open and indoor atria. In both cases the glazing should meet the standards for mechanical resistance, while in the latter also the thermal requirements (U-value and g-value) of the envelope.



Fig. 3.B.22: semi-transparent skylights. Ospedale Meyer, Florence. CSPA Firenze, Paolo Felli, Lucia Ceccherini Nelli, Marco Sala: semi-transparent modules with crystalline cells. © Emanuele Noferini

### 3B4.1.B FACADES

A PV component can substitute the external layer of the facade (i.e. PV as a cladding of a cold facade), or it can substitute the whole façade system (i.e. curtain walls – opaque or translucent)[ 3.B.7]. Depending on the layer(s) the PV component substitutes, it has to meet different requirements that influence the choice of the most suitable PV component.

In the following, a general overview of the way PV can be used in facades is presented.

#### Opaque - cold facade

Photovoltaic modules can be used in all types of façade structures. In opaque cold facades, the PV panel is used as a cladding element, mounted on an insulated load-bearing wall. In this case, the PV is usually back ventilated, to avoid lowering the efficiency of the cells (fig. 3.B.23B). As the cooling air is heated by the panels, some systems make use of it for building heating (PVT).

Several fastening systems have been developed for façade cladding, both with framed panels and laminates (unframed modules) and for all PV technologies (fig. 3.B.23A).



Fig. 3.B.23 A Facade cladding solutions. Left: Soltecture Solartechnik GmbH, Berlin, Germany, © Soltecturel.

Right: Paul-Horn Arena, Tübingen, Germany, Alman-Sattler-Wappner, © Sunways.

Fig. 3.B.23 B Facade cladding solutions: detail of ventilation principle

#### Opaque – non-insulated glazing and warm façade

Curtain wall systems with single glazing (for non insulated facades) or double glazing modules with adequate U-values (fig.24) also offer opportunities for PV integration. These can be either opaque or semi-transparent/translucent.



Fig. 3.B.24: warm façade solution. Zara Fashion Store, Cologne, Germany, Architekturbüro Angela und Georg Feinhals: opaque monocrystalline cells combined with transparent glazing in post-beam curtain wall structure, © Solon.

#### Semi-transparent and translucent façade parts

PV modules for application in semi-transparent/translucent parts of the façade are glazed modules with either crystalline cells covering only a part of the glass area (cells spacing), or amorphous panels with very thin layer and/or larger stripes free of PV (fig 24).



Fig. 3.B.25: Schott Headquarter Mainz, translucent thin film module, © Schott.

Most commonly solar cells are integrated into curtain wall systems to create translucent modules. The different curtain wall structures (post-beam structure, structural sealant glazing and spider glazing systems...) give various possibilities of framing and architectural appearance (fig. 3.B.25).

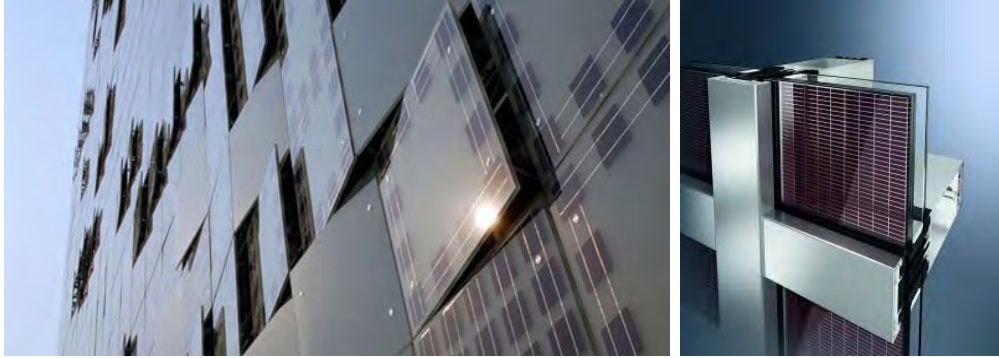

Fig. 3.B.26 GreenPix Media Wall, Beijing, China, Simone Giostra & Partners: frameless modules with spider glazing system, © Simone Giostra & Partners/Arup.

Fig. 3.B.27: Double glazing module with thermal insulation ©: Schueco

When working with a semi-transparent PV in façades, an important consideration is its direct impact on the indoor climate. The solar modules act only as a partial sun protection, and they can also heat the air inside the building. Visual disturbance and daylighting issues have to be considered also.

Special PV elements offering a good thermal insulation (low U-value) are available to be used in combination with standard double or triple glazing elements (fig 3.B.27). The outer layer of a double-skin façade is also a possible option for PV integration.

### 3B4.1.C EXTERNAL DEVICES

Photovoltaics can be also used as external devices on the building skin.

#### PV as sun protection

Photovoltaic modules can be used as shading devices. Quite common these are semi-transparent glass-glass components integrated as canopies or louvers, but there are also movable shutters with semi-transparent crystalline or thin film (fig. 3.B.28).



Fig. 3.B.28: solar shading solution: Left: Colt Ellisse PV sliding shades at Company HQ, Bitterfeld-Wolfen, Germany, © Colt, Right: Keuringsdienst, Eindhoven, The Netherlands, Yanovshchinsky Architekten: using Colt Shadovoltaic as shading device, © Colt.



Opaque sun protections are also well used (fig. 3.B.29), in most cases with an upper part without cells, to avoid shading the PV cells when the shades overlap.



Fig. 3.B.29 SBL Offices Linz, Austria, Helmut Schimek, shading louvers with integrated photovoltaics and suntracking system, © Colt

#### Spandrels, balconies parapets

Spandrels and parapet areas are also suitable for photovoltaic integration, mostly using glass-glass semi-transparent modules made of security glass (SSG). Balcony fronts can either be two-paned solutions to protect the PV-cells or single glasses to which the PV-cell is laminated (fig. 3.B.30). In glazed verandas, the heat generated at the back of the PV can be used to create thermal comfort in spring and autumn, while the space can be opened for natural ventilation in summer time [8].



Fig. 3.B.30: spandrels and parapet solutions. Left: Housing Estate, Ekovikki, Finland, Oy Reijo Jallinoja: semi-transparent PV modules with two-paned glazing in parapet areas, Resource: PV NORD. Right: Kollektivhuset, Copenhagen, Denmark, Domus Arkitekter: PV cells were laminated to a single glass, heat transmitted from the cells was used in an innovative way to create thermal comfort during spring and autumn, during summer they are ventilated with an optimized shaft behind the cells and a coloured shutter through airgaps in the bottom and top of the glazing of the balcony, Resource: PV NORD.

### 3B.4.2 INNOVATIVE ENVELOPE AND EXTERNAL DEVICES SYSTEMS (CURTAINS, LEAVES)

Polymer technologies offer innovative products for special added function like solar curtains for the interior or solar leaves that can replace the ivy running on the wall (fig. 3.B.31). These products have very low efficiency, but their initial cost is also very low. On the other hand they are very sensitive to light and can therefore function well in diffuse light or behind a window.

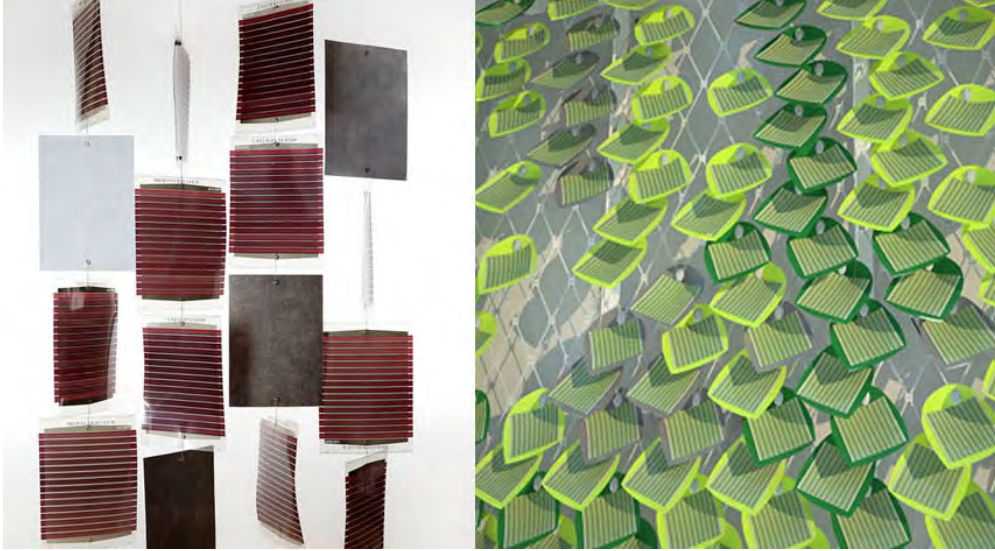
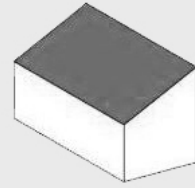

Fig. 3.B.31: innovative third generation PV solutions. Left: Solar Tile curtain with polymer solar cells and phase change material, © Astrid Krogh. Right: Solar Ivy SMIT with polymer solar cells, © SMIT

#### Good integration examples

This section provides a few relevant examples of building integration of photovoltaic systems and their architectural integration achievements are analysed. The criteria used to evaluate the integration quality are set to ensure both the analysis of the functional/constructive integration quality into the building envelope (“Collector used as multifunctional construction element”- see section 2.3 Functional and constructive aspects, p. 7 of this document.) and the formal quality of the integration design (“Field position and dimension”; “Visible materials”; “Surface textures”; “Surface colours”; “Module shape and size”; “Jointing” - see section 2.4 Formal aspects, p. 8 of this document) [3-A.1].

## VELUX Sunlighthouse, Pressbaum, Austria, HEIN-TROY Architekten, 2010



### Monocrystalline cells

#### Building facts

Climate type: continental climate

building size: 165,94 m<sup>2</sup>

Energetic standard: low energy

Constructive aspects: PV-modules in laminated safety glass

#### Solar product

Manufacturer: Ertex Solar GmbH

Peter Mitterhofer Strasse 4

A-3300 Amstetten, ertex-solar.at

Module size: 50 different modules with 7 different geometries

System size: 43,55 m<sup>2</sup> on a pitched roof

System position: south-west

Energy production / nominal power : 6500 kWh / 7,6 kWp

#### Integration achievements

Module used as multifunctional construction element	+
Field position and dimension	+
Visible materials	+
Surface texture / pattern	+/-
Module colour	+/-
Module shape & size	+
Jointing / Fixing	+



VELUX Sunlighthouse  
© Adam Mørk, VELUX





## Milland Church, Bressanone, Italy, Arch. O. Treffer, 1984-85 (Church), 2008 (PV system)

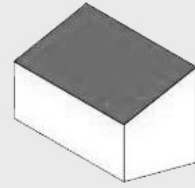

### Monocrystalline cells – back contact technology

#### Building facts

Climate type: Middle-European temperate climate

Building size : 1000 m<sup>2</sup>

Energetic standard : basic

Constructive aspects : retrofit system; the PV modules have been installed on a metal sheet roof

#### Solar product

Manufacturer name: SunPower

Product characteristics: high efficiency and uniform appearance (all-black module) due to the back contact technology

Module size: 1559 mm x 798 mm

System size and orientation : 110 m<sup>2</sup> , South-West oriented

System position in the building : South-West roof

Energy production / nominal power: 19407 [kWh/yr] / 17,83 [kWp]\*

#### Integration achievements

Module used as multifunctional construction element	+/-
Field position and dimension	+
Visible materials	+
Surface texture / pattern	+
Module colour	+/-
Module shape & size	+
Jointing / Fixing	+



Top: photo of the PV installation

Left bottom: photo of the church

Right bottom: photo during construction, the metal roof is still visible

© Laura Maturi - EURAC

\*(value from calculations)

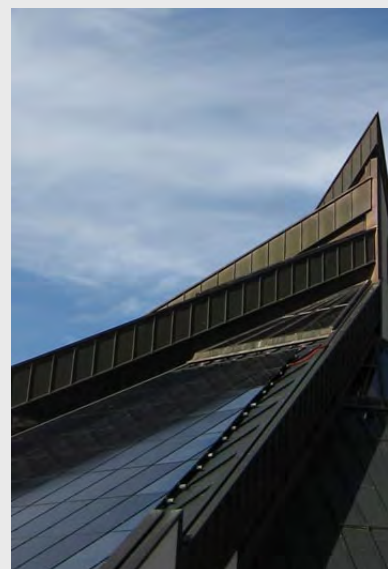



## Kraftwerk B - Residential, Bennau (SZ-CH), Grab Architekten AG, 2008

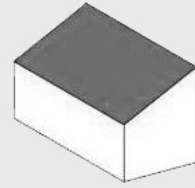

### Monocrystalline cells

#### Building facts

Temperate

6'750m<sup>3</sup>, 1'380m<sup>2</sup>

Minergie-P-Eco (SZ-001-P-ECO)

The envelope of the building is composed of prefabricated units of wood with a considerable thermal insulation of 44cm of thickness

#### Solar product

3s Photovoltaics, Schachenweg 24, CH-3250 Lyss, Switzerland,  
[www.3s-pv.ch](http://www.3s-pv.ch)

Module size: 1.3m x 0.88m

System size: 261m<sup>2</sup>, orientation: south-west

Pitched roof: inclination 40° + pavillon

32'000kWh / 32kWp

#### Integration achievements

Module used as multifunctional construction element	+
Field position and dimension	+
Visible materials	+
Surface texture / pattern	+
Module colour	+
Module shape & size	+
Jointing / Fixing	+







## Industrial – new building, Frasco (TI – CH), Nicola Baserga & Christian Mozzetti, 2009

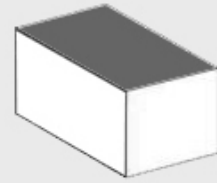

### Thin film cells

#### Building facts

Climate type: Mediterranean

Building size : 790m<sup>2</sup>, 2'600m<sup>3</sup>, shelter for 33 people

Energetic standard : Passive house

Envelope composition (from outside to inside):

- vertical cover with planks of larch wood, mm 25/50
- secondary horizontal planks of larch wood, mm 25/50
- "Stamisol Fassade", black color
- windscreen wood fiber panels, mm 15
- primary wood structure mm 120/180 with interposed mineral wool insulation, mm 180
- inside covering made of three layers panels of pine wood, mm 19

#### Solar product

General Membrane Spa, Via Venezia 28, I-30022 Ceggia (Venice)

[www.generalsolarpv.com](http://www.generalsolarpv.com)

17m<sup>2</sup> for 1kWp, frameless-flexible

Module size: 5.5m x 0.4m

System size: 360m<sup>2</sup>, orientation: south

Flat roof: inclination 5°

20'350kWh / 22kWp

### Integration achievements

Module used as multifunctional construction element	+
Field position and dimension	+
Visible materials	+
Surface texture / pattern	+/-
Module colour	+
Module shape & size	+
Jointing / Fixing	+

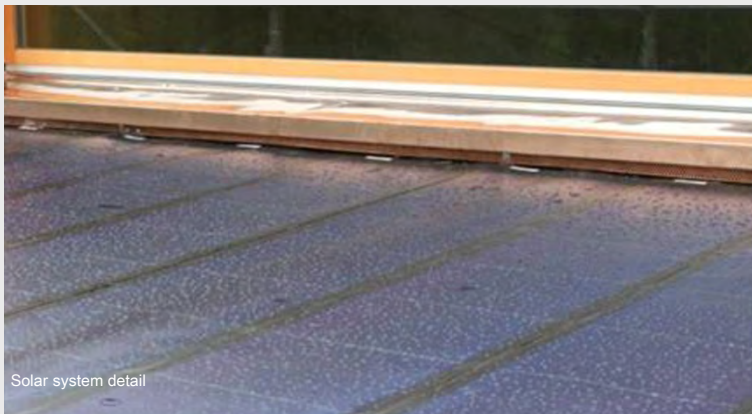



## Paolo VI Audience Hall – Vatican City (SVC), Pier Luigi Nervi, 2008

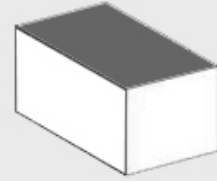

### Multicrystalline cells

#### Building facts

Climate type: mediterranien

building size : n.a.

Energetic standard : n.a.

Constructive aspects : 2394 standard PV modules are installed with rack mounting system on the top of the curvey roof of the new Audience Hall.

#### Solar product

Manufacturer name: Solarworld AG, Martin-Luther-King-Str. 24  
53175 Bonn, Germany

Product characteristics: n.a.

Module size:na.

System size and orientation :2021 m<sup>2</sup>

System position in the building : south, on the top of the roof

Energy production / nominal power: 1309,77 kWp

### Integration achievements

Module used as multifunctional construction element	+/-
Field position and dimension	+
Visible materials	+
Surface texture / pattern	+
Module colour	+
Module shape & size	+
Jointing / Fixing	+



Paolo VI Audience Hall  
© Solarworld AG





# Administration, industrial – new building, St. Asaph (GB), Percy Thomas Architects, 2003

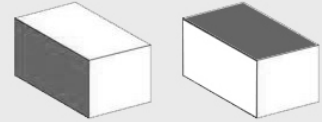

## Thin film cells

### Building facts

Climate type: Temperate maritime  
 Building size: N/A  
 Energetic standard: N/A  
 Envelope composition: N/A  
 Other relevant facts: N/A

### Solar product

Shell Panels, 4650 Adohr Lane, Camarillo, CA 93012, United States, [www.shell.com/renewables](http://www.shell.com/renewables)  
 Uniform appearance, light weight  
 Module size: 1.3m x 0.3m  
 System size: 1'000m<sup>2</sup>, orientation: south  
 Flat roof and covering facade  
 60'000-65'000kWh / 84kWp

### Integration achievements

Module used as multifunctional construction element	+
Field position and dimension	+
Visible materials	+
Surface texture / pattern	+
Module colour	+
Module shape & size	+
Jointing / Fixing	+



Solar system detail



Building global picture

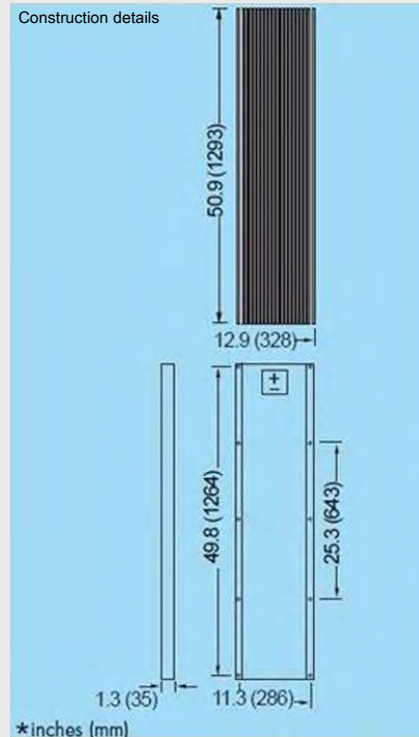



## SurPLUShome, Darmstadt, Germany, TU Darmstadt, 2009

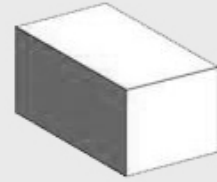

### CIS thin film cells

#### Building facts

Climate type: continental climate

Building size : 60m<sup>2</sup>

Energetic standard : plus energy

Constructive aspects : On the overall facades CIS thin film modules are used as facade cladding on an insulated timber structure. Onto the flat roof monocrystalline modules are integrated.

#### Solar product

Manufacturer: Würth Solar GmbH & Co. KG, Alfred-Leikam-Str. 25, 74523 Schwäbisch-Hall, Germany, [www.wuerth-solar.com](http://www.wuerth-solar.com)

Product characteristics: GeneCIS modules are available in different sizes ranging from 200 x 200 mm to 2600 x 2400 mm.

In the ARTLine Invisible façade system the frameless CIS modules are available in different colours

Modules: frameless CIS-modules, 300 x 1200 mm

System size: 260 modules – 93,6m<sup>2</sup>

System position: all facades, monocrystalline modules on roof

Energy production / nominal power : 7,8 kWp

#### Integration achievements

Module used as multifunctional construction element	+
Field position and dimension	+
Visible materials	+
Surface texture / pattern	+
Module colour	+/-
Module shape & size	+
Jointing / Fixing	+



Photo: Thomas Ott, [www.o2t.de](http://www.o2t.de)

surPLUShome

Left top: photo of the building

© Jim Tetro, DOE

Left bottom: photo of facade

©Thomas Ott

Right bottom: structure of facade

© TU Darmstadt

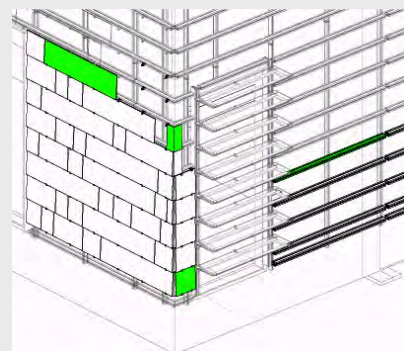





## Multy-Storey Parking, Zwolle (NL), R. Uytenhaak Architectenbureau, 2004

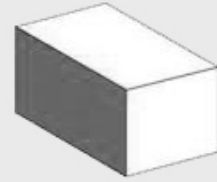

### Thin film cells

#### Building facts

Climate type: Temperate maritime

Building size: 14'000 m<sup>2</sup>

Energetic standard: N/A

Constructive aspects: The facades are designed using a minimum of separate elements. The upper storeys are slightly rotated in relation to each other.

#### Solar product

Manufacturer: Schott Solar, Hattenbergstrasse 10, 55122 Mainz, Germany, [www.schottsolar.com](http://www.schottsolar.com)

Product characteristics: Light weight

Module size: 1m x 0.6m

System size: 1'000m<sup>2</sup>, orientation: south

Facade: inclination 90°;

Energy production / nominal power: 15'000-20'000kWh / 27kWp

### Integration achievements

Module used as multifunctional construction element	+
Field position and dimension	+
Visible materials	+
Surface texture / pattern	+
Module colour	+
Module shape & size	+
Jointing / Fixing	+



Multy-stoyer parking, © PVNORD



## Solteature Solartechnik GmbH, Berlin, Germany, krell.girke architekten, 2009

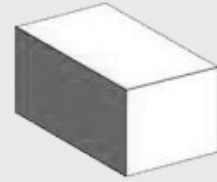

### CIS thin film cells

#### Building facts

Climate type: continental climate

Building size : NA

Energetic standard : basic

Constructive aspects : Solteature standard framed modules are used as facade cladding.

#### Solar product

Manufacturer: Solteature Solartechnik

Solteature Solartechnik GmbH

Groß-Berliner Damm 149

12487 Berlin

Product characteristics: SCG-HV-F Solteature module suitable for roof and cold facade installation with solteature's mounting system

Module size: 1256x658 mm

System size: 700 modules on facade – 5785 m<sup>2</sup>

System position in the building: overall facade

Energy production / nominal power : 40 kW

#### Integration achievements

Module used as multifunctional construction element	+
Field position and dimension	+
Visible materials	+
Surface texture / pattern	+ / -
Module colour	+
Module shape & size	+
Jointing / Fixing	+





## Zara fashion store, Cologne, Germany, Architekturbüro Feinhals, 2003

### Multicrystalline cells

#### Building facts

Climate type: continental climate

building size : appr. 320 m<sup>2</sup>

Energetic standard : basic

Constructive aspects : The façade consists of 16 different types of modules, which are embedded in insulated glass panes. This allows the photovoltaic module to generate electricity while acting as a part of the building's skin. Point brackets hold the laminated solar insulation glass panes in the mullion-and-transom construction, and electrical circuit points and ventilation slits are located discreetly on the back of the module. To prevent output loss through shading, the whole structure is designed with multiple independent power units.

#### Solar product

Manufacturer : Saint Gobain Glass Solar

[www.saint-gobain-solar.com](http://www.saint-gobain-solar.com)

Product characteristics: polycrystalline cells replacing marble

Module size: Vary from 620 mm x 880 mm to 1.165 x 3.080 mm.

System size: 112 single modules are embedded in 78 insulation glass panes with 6585 cells, 140 m<sup>2</sup>

System position in the building: south façade

Energy production / nominal power: 12 kWp



### Integration achievements

Module used as multifunctional construction element	+
Field position and dimension	+
Visible materials	+
Surface texture / pattern	+
Module colour	+/-
Module shape & size	+
Jointing / Fixing	+

Zara Fashion Store

© Solon Referenzen, Photo: Constantin Meyer





## Paul-Horn Arena, Tübingen, Germany, Allman-Sattler-Wappner, Wappner Architekten, 2004

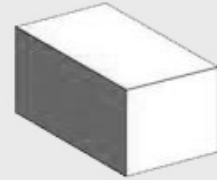

### Multicrystalline cells

#### Building facts

Climate type: continental climate  
 building size : capacity for 3000 persons  
 Energetic standard : basic  
 Constructive aspects : module structure: 8 mm laminated safety glass (white), Cell level, EVA back foil

#### Solar product

Manufacturer: Sunways AG, Macairestraße 3 – 5, D - 78467 Konstanz, [www.sunways.eu](http://www.sunways.eu)  
 The product is available in different colours  
 System size: 520 m<sup>2</sup> façade area, approximately 950 modules in four different sizes  
 Module size: standard: 511x1008mm, 3 x 7 solar cells  
 System position: south-west façade  
 Energy production / nominal power :30 000 kWh / 43,7 kW

#### Integration achievements

Module used as multifunctional construction element	+
Field position and dimension	+
Visible materials	+
Surface texture / pattern	+
Module colour	+
Module shape & size	+
Jointing / Fixing	+



Paul-Horn Arena  
© Sunways AG







## Home+, Madrid/Stuttgart, Germany, Hochschule für Technik Stuttgart, 2010

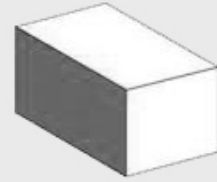

### Mono-, and polycrystalline cells

#### Building facts

Climate type: mediterranean/continental

building size : 75 m<sup>2</sup>

Energetic standard : low energy

Constructive aspects: On the facade 156 x 156 mm size, shimmering colorful golden and bronze polycrystalline solar cells are embedded in glass-glass modules. On the roof innovative new type of PV/T-collectors are installed that are designed for a most efficient night cooling with PCM ceiling and maximum power output during the day.

#### Solar product

Manufacturer of modules: Ertex Solar GmbH, Peter Mitterhofer Strasse 4,A-3300 Amstetten, <http://ertex-solar.at/cms/>

Solar cells: Sunways AG, <http://www.sunways.eu/de/>

Product characteristics: Facade: different patterns with colorful cells

Module size: facade-1194x2972 mm, roof-1194x1022/2324 mm

System size: facade-49,68 m<sup>2</sup>, roof- 55,93 m<sup>2</sup>

System position in the building : eastern-western facade, flat roof

Energy production / nominal power: 11.500 kWh /a, 12 kWp

#### Integration achievements

Module used as multifunctional construction element	+
Field position and dimension	+
Visible materials	+
Surface texture / pattern	+
Module colour	+
Module shape & size	+
Jointing / Fixing	+



home+

Left top: close-up image

Bottom: photo of the building

©Prof. Dr. Jan Cremers



## Schüco Office, Padova, Italy B+B Associati Studio di Architettura , 2009

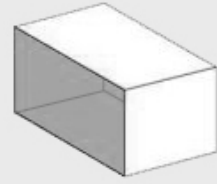

### Semi-transparent thin film cells

#### Building facts

Climate type: humid subtropical climate

building size : 31,000 m<sup>2</sup>

Energetic standard : Highly energy efficient building envelope, and self-sufficient with renewable energy from: photovoltaics, solar thermal, solar cooling (absorption), geo-thermal and heat pumps.  
Constructive aspects: Double-skin façade where the outer skin is a post-rail construction with integrated semitransparent thin-film PV.

#### Solar product

Manufacturer name: Schüco International KG

Product characteristics: Schüco ProSol TF can feature a variety of colors and surface textures and even patterns or logos

Module size: Custom-built modules in various sizes up to 5.72 m<sup>2</sup> (2.2 m x 2.6 m) with no joint

System size: double façade with PV extending about nine meters.

System position in the building : South façade

Energy production / nominal power: 50 to 55 Wp/m<sup>2</sup> with semi-transparent modules (20% transparency)

#### Integration achievements

Module used as multifunctional construction element	+
Field position and dimension	+
Visible materials	+
Surface texture / pattern	+
Module colour	+
Module shape & size	+
Jointing / Fixing	+



Schüco Office, Padova © Schüco

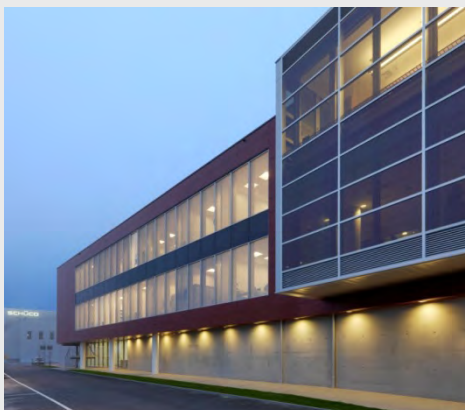



## GREENPIX Zero Energy Media Wall, Beijing, China, Simone Giostra & Partners, 2008

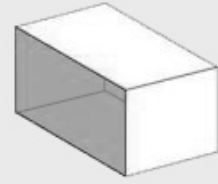

### Multicrystalline cells

#### Building facts

Climate type: Temperate continental climate

building size :44 000 m<sup>2</sup>

Energetic standard : basic

Constructive aspects (envelope composition): The polycrystalline photovoltaic cells are laminated within the glass of the curtain wall and placed with changing density on the entire building's skin.

Other relevant facts: The density pattern increases the building's performance, allowing natural light when required by interior program, while reducing heat gain and transforming excessive solar radiation into energy for the media wall.

#### Solar product

PV technology R&D: Schüco International KG, Sunways AG

PV manufacturer: Suntech China

Product characteristics: flexibility in translucency, pattern of cells

Module size: 1x1 m with varying number of 156x156mm cells

System size: 2292 custom-made solarmodules (2292 m<sup>2</sup>)

System position in the building: East facade

Energy production / nominal power

#### Integration achievements

Module used as multifunctional construction element	+
Field position and dimension	+
Visible materials	+
Surface texture / pattern	+
Module colour	+
Module shape & size	+
Jointing / Fixing	+

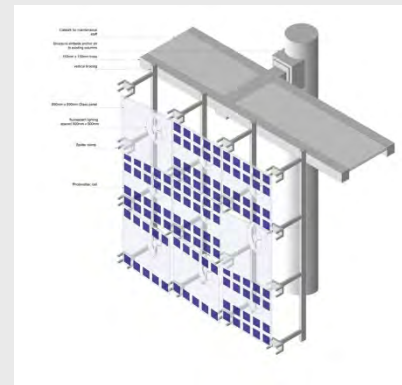

GreenPix Media Wall  
 Left top: close-up image  
 Left bottom: photo of the facade  
 Right top: structure  
 ©Simone Giostra & Partners/Arup



## Opera House, Oslo, Norway, Snøhetta, 2007

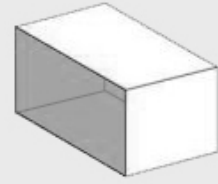

### Monocrystalline cells

#### Building facts

Climate type: humid continental climate

building size : 38.500 m<sup>2</sup>

Energetic standard : basic

Constructive aspects : The photovoltaic cells are griuped in horizontal lines and integrated into the southern curtain wall facade glazing. The lines are copied on the north façade with dummy elements.

#### Solar product

Manufacturer name: Schüco International KG avd. Norge

PB 56, Bogerud, 0621 Oslo, <http://www.schueco.com/web/no>

Product characteristics: custom-made products

Module size:na.

System size and orientation :300 m<sup>2</sup>

System position in the building : southern façade

Energy production / nominal power: 20600 kWh/year, 35 kWp

#### Integration achievements

Module used as multifunctional construction element	+
Field position and dimension	+
Visible materials	+
Surface texture / pattern	+
Module colour	+/-
Module shape & size	+
Jointing / Fixing	+







## Uffici C.M.B., Rome - Italy, 2009, 3c+t Capolei Cavalli Architetti

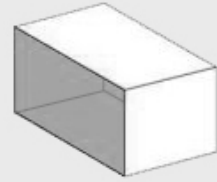

### Polycrystalline cells

#### Building facts

Climate type: continental

building size: about 2800 m<sup>2</sup>

Energetic standard : /

Constructive aspects (envelope composition): The building is the CMB (one of the main construction companies in Italy) headquarter in a new district close to Rome.

The main feature is a large PV façade, which harmonizes with a ventilated brick façade. Colors, textures, grains, and transparencies of the custom made glass-glass PV modules are designed to match the traditional materials of the building, and also to allow optimal internal day-lighting conditions.

#### Solar product

Manufacturer: Schüco

colours: green-grey

The façade integrates 155 PV cells (10mm\*10mm).

Nominal power: 75kW<sub>p</sub>

#### Integration achievements

Module used as multifunctional construction element	+
Field position and dimension	+
Visible materials	+
Surface texture / pattern	+
Module colour	+
Module shape & size	+
Jointing / Fixing	+

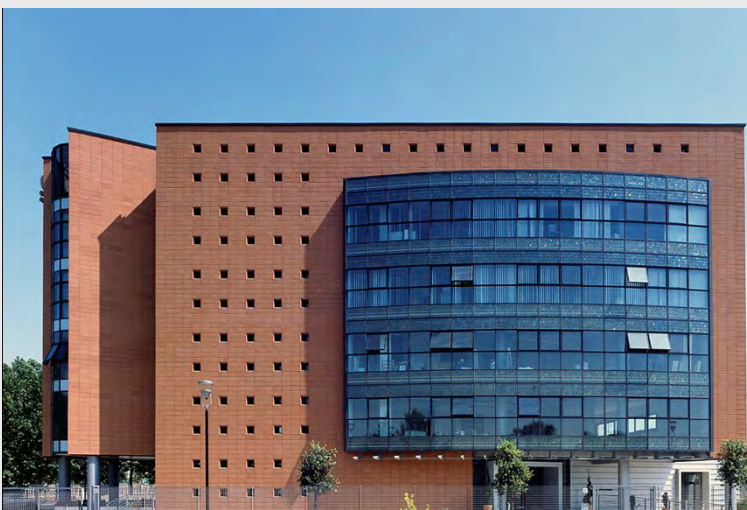



## Hotel-renovation, Paris (F), Emmanuel Saadi Architecture, 2007

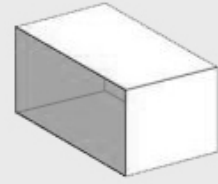

### Monocrystalline cells

#### Building facts

Continental

6'900m<sup>2</sup>

Energetic standard: N/A

Envelope composition: N/A

Historical building. There is also a heat pump that recycles a portion of air and thus decreases the intake of fresh air and therefore the energy cost of air treatment.

#### Solar product

Optisol Scheuten Solar, van Heemskerckweg 30, 5928 LL Venlo, Netherlands, [www.scheuten.com](http://www.scheuten.com)

Module size: Custom made (330 modules)

System size: 1'010m<sup>2</sup>, orientation: south and west

Facade covering and parapet: inclination 90°

76'000kWh / 123kWp

#### Integration achievements

Module used as multifunctional construction element	+
Field position and dimension	+
Visible materials	+
Surface texture / pattern	+
Module colour	+
Module shape & size	+
Jointing / Fixing	+



Solar system detail



Building global picture



Solar system detail



## City of Design, Saint Etienne - France, 2009, design LIN (Fin Geipel + Giulia Andi)

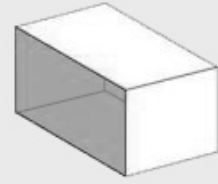

### Monocrystalline cells

#### Building facts

Climate type: continental

building size : about 64000 m<sup>2</sup>

Constructive aspects (envelope composition): The PV system is fully integrated into the design of the project. The roof covering consist of 14000 equilateral triangles (wide 1.20m) of different materials, part of those integrates photovoltaic cells (10 mm X10 mm). The average texture of the covering is made by arranging different kinds of triangles having different properties (translucent metal mesh; glass with integrated brisde-soleil strips, photovoltaics, insulating and experimental dark greens) and visual aspect.

#### Solar product

Manufacturer: Schüco / [www.schueco.com](http://www.schueco.com)

colours : grey - blue

Each solar module is 1.20 m wide.

The roof is composed of 325 photovoltaic custom designed: glass-glass modules for a total system surface of 205 m<sup>2</sup>.

Energy production / nominal power : about 964 KWh/KWp

### Integration achievements

Module used as multifunctional construction element	+
Field position and dimension	+
Visible materials	+
Surface texture / pattern	+
Module colour	+
Module shape & size	+
Joining / Fixing	+

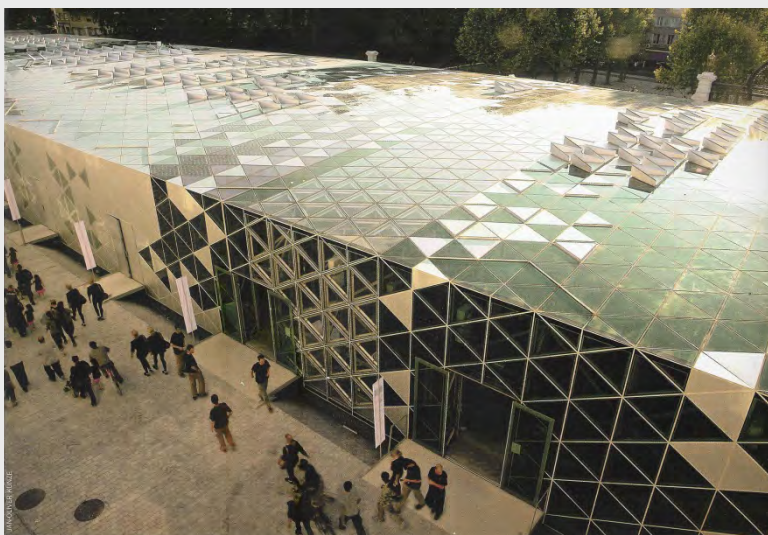



## Single Family House, Gutenberg, Austria, Büro Kaltenegger, 2007

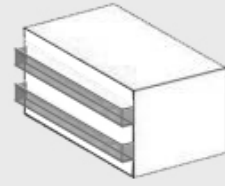

### Multicrystalline cells

#### Building facts

Climate type: continental climate

building size : 142 m<sup>2</sup>

Energetic standard : passive house

Constructive aspects : the solar cells are protected by a coat of safety glass, the modules are attached to the ballustrade by point mounts not visible from outside

#### Solar product

Manufacturer name: Ertex solartechnik GmbH

Peter Mitterhofer Strasse 4

A-3300 Amstetten, ertex-solar.at

Product characteristics: custom made product

Module size: na.

System size and orientation : 60 m<sup>2</sup>, west and south-north

System position in the building : ballustrade

Energy production / nominal power: 14,5 kWh/m<sup>2</sup>a, 4,9 kWp

### Integration achievements

Module used as multifunctional construction element	+
Field position and dimension	+
Visible materials	+
Surface texture / pattern	+
Module colour	+/-
Module shape & size	+
Jointing / Fixing	+



Single Family House,  
© Kaltenegger







## Hotel Leon d'Oro, Bari-Italy, 2010, design Netti Architetti



### Multicrystalline cells

#### Building facts

Climate type: continental

building size: /

Energetic standard: basic

Constructive aspects (envelope composition): this is a retrofit on a hotel built in the 70s. The existing sun-shading polycarbonate panels of the façade have been substituted with PV glass-glass modules (77% opacity), having the same shape and dimensions of the former ones. The tilt is optimized on the latitude of the installation site. The PV system produces about 1/3 of the hotel energy consumption.

#### Solar product

Manufacturer: EPC/Tecnomec Engineering

Colour: blue

The custom designed PV glass-glass module has an area of 2,65 m<sup>2</sup> and a nominal power of 285 W<sub>p</sub> for a total nominal power of the system of 24KW<sub>p</sub>.

Energy production: 34MWh/year (1,66kWh/kW<sub>p</sub>)

#### Integration achievements

Module used as multifunctional construction element	+
Field position and dimension	+
Visible materials	+
Surface texture / pattern	+
Module colour	+
Module shape & size	+
Jointing / Fixing	+

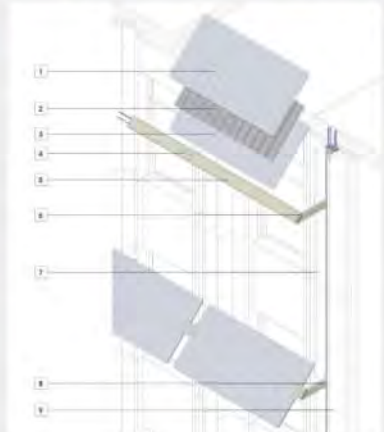



## Polins, Portogruaro (VE), Italy, Marco Acerbis, 2010

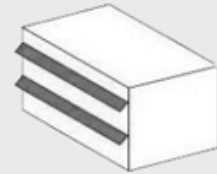

### Multicrystalline cells

#### Building facts

Climate type: Temperate continental climate  
building size: +/- 400 m<sup>2</sup>

Energetic standard : CASACLIMA A+ (10kWh/m<sup>2</sup>/year).

Constructive aspects (envelope composition): Polins is the first office building in Italy labeled Casaclima A+ energy standard; it is equipped with PV and geothermal systems. Its main feature is the curved roof, which shapes the envelope. A PV shading device made of standard modules is integrated into the wooden structure of the roof.

#### Solar product

Manufacturer: Kyocera Fineceramics

The modules are blue. Each solar module is 652 mm\*1425 mm.  
The roof is composed of 3 rows each one composed by 14 modules with a total PV surface of 37.8m<sup>2</sup>

System position in the building: south façade, slope: 35 ° ;

Nominal power: 5,76 kW<sub>p</sub>

### Integration achievements

Module used as multifunctional construction element	+
Field position and dimension	+
Visible materials	+
Surface texture / pattern	+
Module colour	+
Module shape & size	+
Jointing / Fixing	+

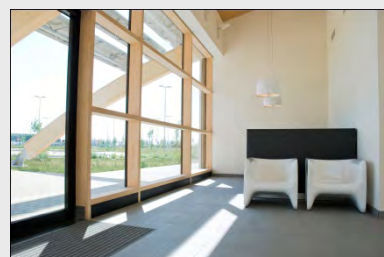



## O.L. Vrouw Hospital - enlargement, Aalst (B), VK Studio, 2009

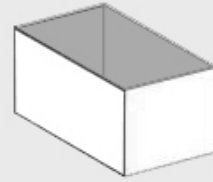

### Multicrystalline cells

#### Building facts

Temperate maritime  
96'000m<sup>2</sup>  
Energetic standard: N/A  
Envelope composition: N/A  
Other relevant facts: N/A

#### Solar product

Optisol Scheuten Solar, van Heemskerckweg 30, 5928 LL Venlo, Netherlands, [www.scheuten.com](http://www.scheuten.com)  
Module size: Custom made (236 modules, most of them 1.2x2.4m)  
System size: 500m<sup>2</sup>, orientation: south  
Facade: inclination 45°  
Energy production / nominal power: 31'122kWh / 46kWp

#### Integration achievements

Module used as multifunctional construction element	+
Field position and dimension	+
Visible materials	+
Surface texture / pattern	+
Module colour	+
Module shape & size	+
Jointing / Fixing	+

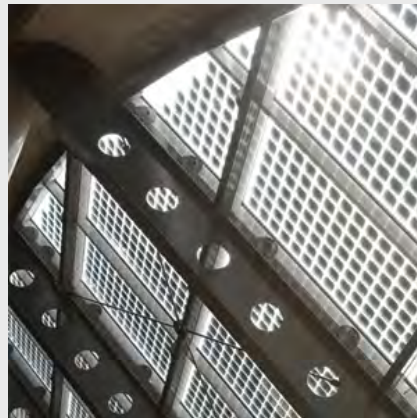

O.L.Vrouw Hospital  
Left top: photo of the building  
Right top: solar system detail  
© SAPA Solar  
Bottom: photo of interior  
© VK Design





## Private residence - new building, Genolier (Vaud), Arch. Philippe Guibout, 2008

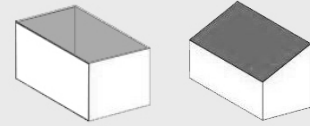

### Thin film and monocrystalline cells

#### Building facts

Climate type Continental  
Building facts: N/A

#### Solar product

Scott AG, Hüttenstrasse 1, 31073, Grünenplan, Germany,  
[www.schott.com/architecture](http://www.schott.com/architecture)

S.E.S. Société d'Énergie Solaire, Route de Saint-Julien 129,  
1228 PLAN-LES-OUATES, Geneva, Switzerland, [www.societe-energie-solaire.com](http://www.societe-energie-solaire.com)

Part of North & South roof	Rest of South roof
ASITHRU-2-IO (1x1.2m), ASITHRU-4x-IO (1.2x2m)	SwissTile (0.4x0.3m)
System size: 557m <sup>2</sup>	System size: 454m <sup>2</sup>
Inclination: 20°	Inclination: 20°
22'000kWh / 22.9kWp	73'500kWh / 68.04kWp

#### Integration achievements

Module used as multifunctional construction element	+
Field position and dimension	+
Visible materials	+
Surface texture / pattern	+
Module colour	+
Module shape & size	+
Jointing / Fixing	+







### 3B.5 PV PRODUCTS AND FORMAL FLEXIBILITY FOR BUILDING INTEGRATION

From the building integration point of view, the market is divided into two main categories: the *standard modules* (Fig. 3.B.32.) and the *building dedicated products*. Both categories give some formal flexibility in their offer, but obviously not to the same extent. As PV has to compete with long existing technologies to generate electricity at a reasonable price, most producers have turned to very large factories to mass-produce PV modules, achieving economies of scale, but limiting their offer to a few standard products.

The standard PV modules have crystalline or amorphous PV cells encapsulated between a front glass and a back sheet of Tedlar (or a back glass) to protect them against mechanical stress, weather conditions and humidity. Most modules have a rectangular shape with specific sizes, often available with or without aluminium frame. Several mounting systems are available for the integration of standard modules. The real flexibility in formal characteristics when using standard modules resides mainly in the wide choice of manufacturers, not in most manufacturers' limited palette. Their fixed sizes and crude frames can make their integration difficult, as they often do not match the raster of the project. However, if the PV option is considered at a very early design stage, an innovative and successful integration can be achieved.



Fig. 3.B.32: standard modules - a sample of the market offer [3-B.14].

Among building dedicated products we can also distinguish between standardized and customizable products. In the first case the producer offers a palette of building dedicated products that are mass-produced, while in the latter the producer offers the possibility of custom-made products individually produced for a certain project. Another categorization of building dedicated products is the following [3-B.9]:

- *Products developed to match and replace existing building products*

These are BIPV products inspired from existing building components that formally match existing building products and are compatible with their mounting systems. This happens most commonly for roof systems (tiles, shingles).

- *Complete PV systems developed for building integration*

These products are complete systems including PV modules with mounting and interface components (often providing dummy elements). Examples of such systems are available for roofs and for façades.

- *Custom-made products developed for special projects*

For maximum flexibility, custom-made products can be ordered with specified formal characteristics (shape, size, colour, texture...etc.). This freedom usually comes with an extra cost due to small quantities produced, and attention should be given to the issue of spare parts, which should be produced with the main order, to ensure replacement in case of incident.

In the first two categories, the challenge for the user is to be aware of the many existing products and to know how to apply them in his work.

A collection of such systems is shown in the sheets of "innovative products"

Crystalline modules

- *Shape and size*

The size of standard photovoltaic modules ranges from 0.2 to 2 m<sup>2</sup>, with a large variety between manufacturers. The small size of the cells used (10/10 cm or 12,5/12,5 cm or even 15,6/15,6 - 20/20 cm) gives the dimensional possible "steps", as the module will have dimensions a multiple of these cells size. Opaque and translucent modules, with or without frame, can then be obtained in a large variety of shapes and sizes, either from a manufacturer's offer or custom made.



Fig. 3.B.33 Standard modules, monocrystalline, © Kyocera

- *Colour, patterns, textures*

The appearance of the modules is mainly defined by the appearance and composition of the cells, and marginally by the colour of the back coating (Tedlar). There is certain flexibility in choosing the colour of cells (Fig 38-39) and of the Tedlar, but black or blue cells and black or white Tedlar are largely dominant. Only a few manufacturers propose coloured cells, so these are quite rare and come with added cost and reduced efficiency (figs. 3.B.34-35) [3-B.10].



Fig. 3.B.34: colour palette for monocrystalline cells, © System Photonics

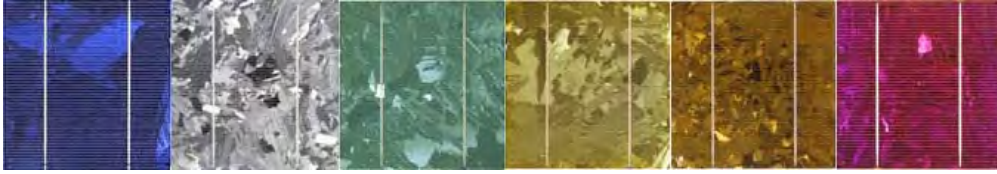

Fig. 3.B.35. multocrystalline silicon wafers; first the blue antireflective standard colour with the best efficiency, the second is the original wafer without reflective layer, then cells with other colours that have different anti-reflective layers, © Sunways

The grey metallic grid collecting the current for all these cells can also have various patterns depending on the manufacturer (fig. 3.B.36).

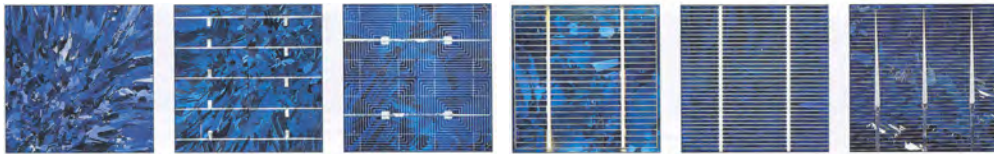

Fig. 3.B.36. different variations of the pattern of metallic grid on multocrystalline cells, © IEA - PVPS Task 7

In semitransparent modules the translucency can be controlled by varying the number of cells (power density) and the distance between the cells. The cells can be grouped in lines to express horizontality or verticality. Furthermore, the pixel-like composition of the cells creates a playground for several artistic expressions (fig. 3.B.37)[3-B.11][3-B.24][3-B.25].



Fig.3.B.37.Left: GreenPix Media Wall, Beijing, Simone Giostra and Partners – pixels arranged in artistic composition, © Simone Giostra and Partners/Arup, Right: Opera House, Oslo, Norway, Snøhetta – horizontally grouped cells, © Farkas

- *Front glass*

The standard choice for front glass is an extra-white, low iron, 3mm glass, used by most producers. There are however options to choose textured or etched extra-white glass, or very thick glass for increased static resistance or for combination with a back glass.

- *Jointing/Framing*

Jointing can be made through the aluminium framing, by integration into curtain-wall systems with mullion/transom, or modules can be integrated frameless in glazing systems, with negative jointing. For roof applications, overlapping is often chosen for the horizontal joint. Custom-made products can be developed with their own specific framing as well, where the frame becomes part of the module design.

### Thin film modules

In thin film technology a homogeneous thin layer of semiconductor material is deposited directly onto a substrate. The form of the cell is almost invisible; the module appears mostly as a homogenous surface with thin parallel lines.

One main difference here comes from the various substrates on which the cells are deposited: rigid glass, bendable stainless steel or plastic materials. Optionally, when deposited on glass, a certain level of transparency can be offered, either by varying deposition thickness or cells spacing.

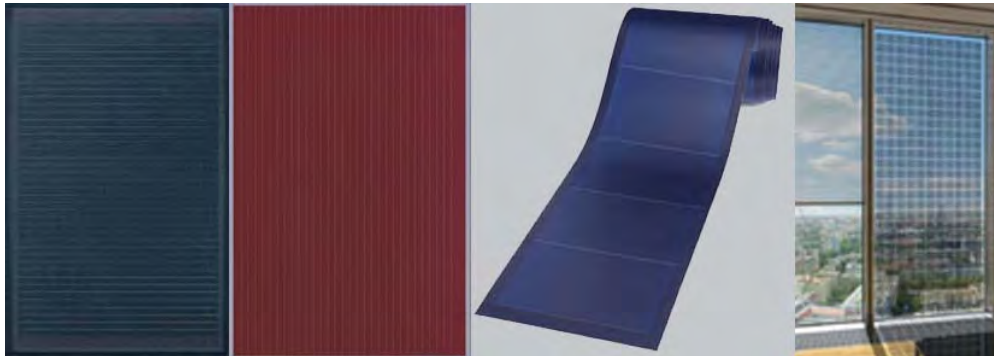

Fig. 3.B.38: black thin film module © Sharp, magenta thin film module © Rixin, solar laminate, © Unisolar, translucent thin film module, © Schüco

- *Shape and size*

Producers generally offer standard glass modules with specific size. A set of standardized building dedicated products is also available on the market.

Thin film cells are deposited on metal however thin film laminates are offered in two versions, one with flexible stainless steel and the other with plastic substrate material [3-B.11]. In both cases the covering material is plastic, therefore the laminate has a plastic appearance. Due to the roll-to-roll manufacturing process, there is only flexibility (a set of dimensions to choose from) in the length of the laminates which come with a fixed width. They are particularly suitable for metal roofs, flat roofs or metal cladding, and several roofing companies are cooperating with the PV producers to offer their products (standing seam/ click-roll-cap metal roofs, corrugated sheets, insulated panels) with integrated PV (fig. 3.B.39.).



Fig. 3.B.39: flexible thin film laminates. Left: thin film laminate with plastic substrate using a galvanized steel plate to mount on a corrugated sheet curved roof, © Flexcell. Right: thin film laminate with stainless steel substrate glued on a standing seam metal roof, © Unisolar.

- *The colour of the modules*

Most manufacturers provide basic thin film products in one single colour, brown, blue or black. New developments offer now also some reddish brown, chocolate-brown, hepatic and sage green colours (fig.40).

Laminates are mainly available in dark blue and pinkish shades.



Fig3.B.40: coloured thin film modules in reddish brown, chocolate-brown, hepatic and sage green, © Rixin

- *Texture and pattern*

Standard opaque modules have a homogeneous surface with fine lines, however the technology allows the possibility to produce semi-transparent modules with a variety of patterns (point, stroke, stripes, fig. 3.B.41), by laser cutting. These modules are encapsulated into glass laminates or double-glazing, suitable for use in extensive glazing or conventional curtain walls.

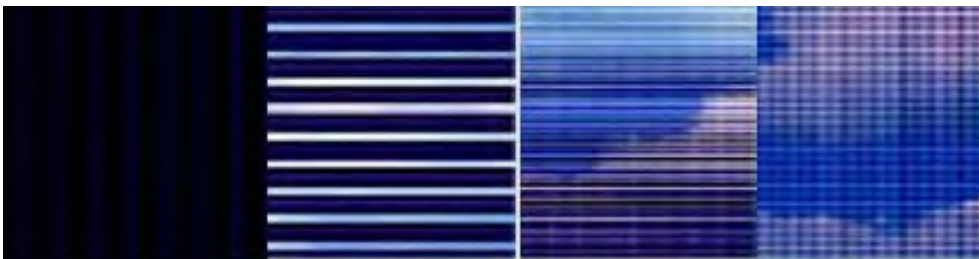

Fig. 3.B.41: thin film modules with different pattern and level of translucency. From left to right: opaque module, translucent glass-glass modules with different pattern, © Schott.

Thin film laminates present the general image of a dark blue or magenta cells ribbon, with two empty lateral areas without cells, 2-5cm wide, where the substrate (black or white) is visible. A specific product is the solar shingle, where the shape, size and pattern of the solar laminate imitate traditional asphalt roof shingles (fig. 3.B.42).

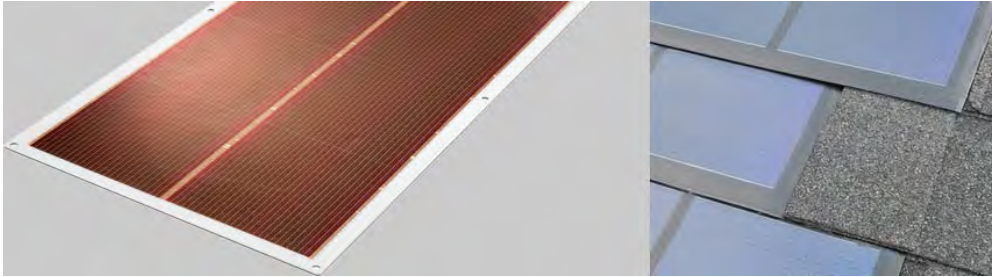

Fig. 3.B.42: texture of flexible thin film laminates. Left: thin film laminate with plastic substrate, © Flexcell; Right: solar shingle with the shape and size of asphalt shingles, © Unisolar.

#### - *Jointing/Framing*

For glass modules, the framing possibilities are the same as for crystalline products.

The jointing and framing of the laminates are defined by their substrate structure. Some laminate producers are partnering with building component manufacturers to integrate their modules into existing building products (fig. 3.B.43).

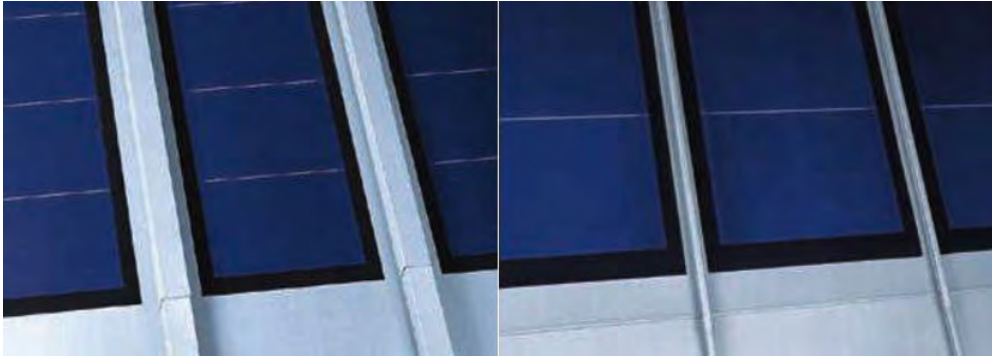

Fig. 3.B.43: solar laminate integrated into metal roof system Left: Click roll cap jointing, Right: Standing seam jointing, © Rheinzink

### 3.B.5 INNOVATIVE PRODUCTS

The following sheets present a collection of innovative market products able to offer to designers enhanced building integration possibilities. The integrability of products is evaluated according to a set of criteria derived from the considerations presented in chapter 2 of this document. The three grades evaluation scale varies from “-” for a negative appreciation, to “+” for a positive appreciation, with +/- considered as neutral.



## Lumeta Power Ply

Irvine HQ, 17182 Armstrong Ave.,  
Irvine, CA 92614  
www.lumetasolar.com

Lumeta PowerPly is a Building Integrated Photovoltaic module for low slope applications. Lumeta™ utilizes monocrystalline cells to maximize energy output per roof area, and a standard EVA based cell encapsulation process. The fiberglass-reinforced plastic (FRP) substrate in the PowerPly™ design provides needed rigidity to the module, replacing the TPT™ (Tedlar®/ Polyester /Tedlar®) flexible substrate used in traditional modules. This technology is enhanced by Lumeta’s adhesive backing material, which eliminates the need for rack mounting systems, yielding seamless integration with the roof. The adherence properties of this adhesive material exceed all wind uplift requirements for roof mounted modules, and its chemical composition is compatible with most roofing surfaces. This direct roof application reduces installation time by about 60% and Balance of System (BOS) costs by up to 50%.

### PV "Integrability" characteristics

Multifunctional element	+
Shape & size flexibility	-
Pattern choice	-
Colour choice	-
Joining / frame	+
Availability of dummies	-
Complete construction system	-

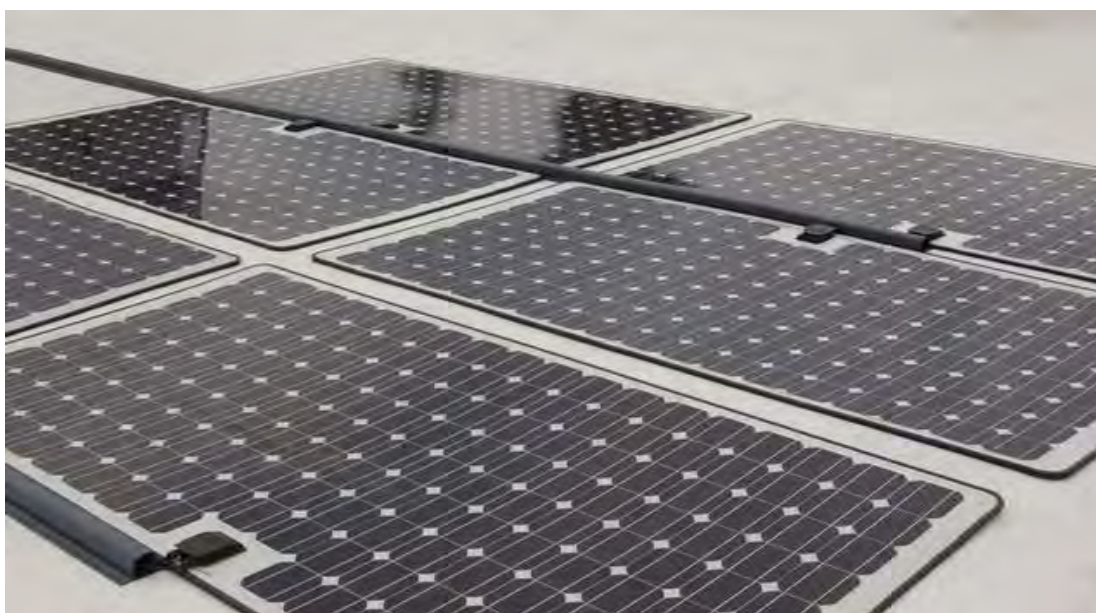

Lumeta PowerPly integrated on flat roof, © Lumeta







3S PHOTOVOLTAICS  
SOLAR BUILDING TECHNOLOGIES

### 3S, Megaslate II

Schachenweg 24, CH-3250 Lyss, Switzerland  
info@3-s.ch  
www.3s-pv.ch

The MegaSlate II® Solar roof system replaces conventional roof tiles either as a complete or partially integrated roofing material.

It involves frameless PV laminates which are used as large solar tiles. Each module is laid on two hooks, which are fixed to a special lathing. Sealing is achieved thanks to a vertical overlapping and vertical profiles that collect rain water. Custom-manufacturing modules allow integration with roofing elements such as skylights or chimneys. The manufacturer suggests to use the MegaSlate II system for roof surfaces with an angle of inclination of at least 20°.

The modules can be installed very easily and quickly on wood structured roofs. Dimensions are limited to 1300 x 875mm but in addition to the PV modules, solar thermal collectors and skylights can be inserted in the construction, always maintaining the aesthetics and homogeneity of the product. Dummy modules are also available.

#### PV "Integrability" characteristics

Multifunctional element	+
Shape & size flexibility	+ / -
Pattern choice	+
Colour choice	-
Jointing / frame	+
Availability of dummies	+
Complete construction system	+

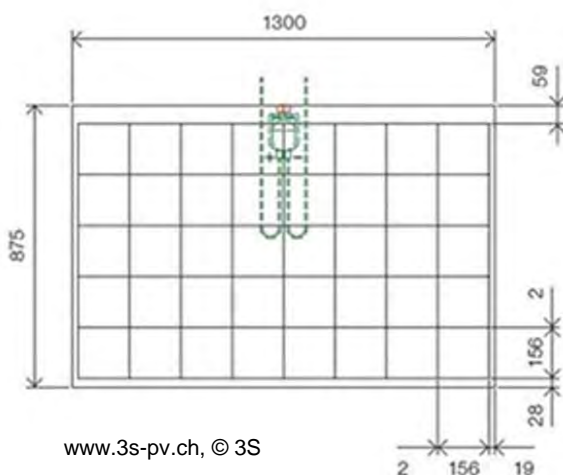

Frameless Megaslate II,  
© 3S



House in Cudrefin (FR-CH),  
© 3S



House Rakusa in Ruvigliana  
(TI-CH), © 3S





## Systaic AG

[www.systaic.com](http://www.systaic.com)

Flat surface completely covered with glass, covered frame glass corners protected by PU.  
 Capacity transmitted in frames, no loose cables.  
 Louvre window able to be integrated in the roof grid, frames covered with glass like the energy units.  
 Folding shutter, expandable up to three rows horizontally; electrically operable; installable for completion of balconies, roof terraces, etc.  
 Dimensions: 1.045 x 1.045 x 40 mm  
 Weigh: 18 kg

### PV "Integrability" characteristics

Multifunctional element	+
Shape & size flexibility	-
Pattern choice	-
Colour choice	-
Jointing / frame	+
Availability of dummies	+
Complete construction system	+







**SOLAIRE FRANCE** Solaire France, Sunstyle

Site Tecnosud, 280 Rue James Watt, 66000 Perpignan, France  
 info@solairefrance.fr  
 www.solairefrance.fr

The Sunstyle system is a multipurpose solar system which allows generating solar current while meeting standards of functionality, performance and durability. This product is an evolution of a standard building PV element for roofs. The tiles are structural components whose manufacturing process was especially developed and certified. The crystalline solar cells are coated with a layer of EVA (Ethyl Vinyl Acetate) and then laid between a soaked frontal glass and a tedlar sheet at the back. The edges are closed, without framework, to avoid penetration of moisture in order to ensure the durability of the elements. The modularity of the system is thought for roofs and it is easy to install together with non active systems (dummies). The Sunstyle system can be also used for retrofitting by substitution of existing roof tiles.

**PV "Integrability" characteristics**

Multifunctional element	+
Shape & size flexibility	+
Pattern choice	-
Colour choice	-
Joining / frame	+
Availability of dummies	+
Complete construction system	+

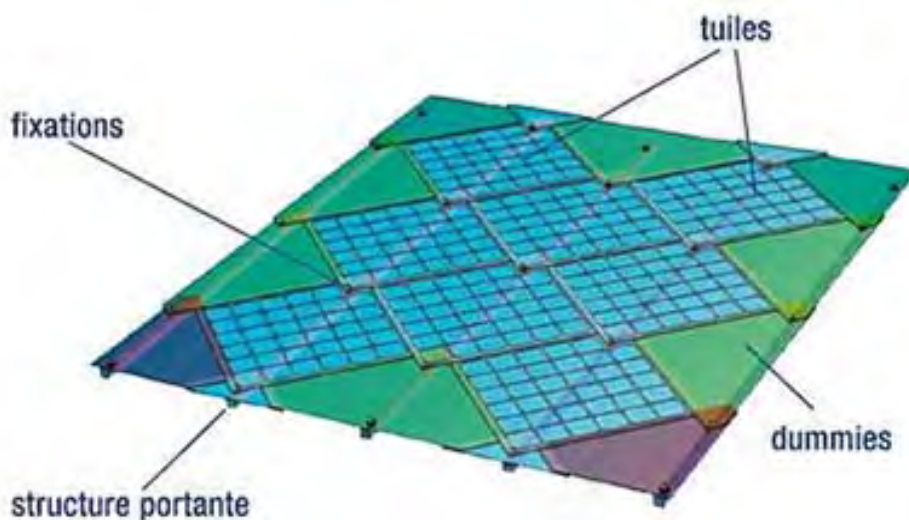

www.solairefrance.fr, © Solaire France



Sunstyle modules ,  
 © Solaire France



Saint-Charles International,  
 © Solaire France



www.solairefrance.fr ,  
 © Solaire France





## COLT Shadovoltaic, PV Louvre

### Colt International

New Lane, Havant, Hampshire, PO9 2LY, UK  
 ideassolar@t-email.hu  
<http://www.coltinfo.co.uk/products-and-systems/architectural-solutions/solar-shading-systems/products/shadovoltaic/>

Colt Shadovoltaic is a fixed or controllable external glazed solar shading system that may be installed either vertically or horizontally in front of the façade. Photovoltaic cells (whether monocrystalline or multicrystalline) are integrated into the glass so as to generate electricity. The systems may be combined with other Colt products such as rooflights and glazed facades. It can be used to reduce solar heat gain, lower air conditioning needs, and lessen glare whilst permitting the use of natural daylight. Two standard systems are available, and bespoke designs can be provided.

Shadovoltaic shading systems are operated by linear actuators that have the capability to operate complete facades. The glass louvres are available in various colours, surface finishes and coatings to meet specific design requirements.

### PV "Integrability" characteristics

Multifunctional element	+
Shape & size flexibility	+
Pattern choice	+
Colour choice	+
Joining / frame	+
Availability of dummies	-
Complete construction system	+



Colt Shadovoltaic, © Colt International Licensing Ltd., 2011



Heraeus, Frankfurt, Germany, © Colt International Licensing Ltd., 2011



Colt Ellisse PV sliding shades at Company HQ, Bitterfeld-Wolfen, Germany, © Colt International Licensing Ltd., 2011







## TMT Solar Tile Systems

### IdeaS Solar Ltd. Hungary

Petőfi S. út 49., Harsány H-3555 Hungary  
 ideassolar@t-email.hu  
<http://www.ideassolar.hu>

Solar cell roof tiles produce electricity by altering solar energy, and as regards their application, their primary benefit is that they can be applied as either solar cell roof tiles that have a form, size, color, and identical fixing points identical with the type and form of any existing roof tile or roof covering, or they can be the actual roof tiles piece by piece on a particular roof. The solar cell roof tiles are equipped with their own special chargeable batteries, thus there is no need for external batteries and/or a separate room for the storage of batteries. The TMT Solar Tile Systems® units are also manufactured without batteries, and in such case they supply electric appliances directly connected to them. No separate electricity collecting rail or cable connections are required for the TMT Solar Tile Systems® units, because they are integrated in the appliance.

### PV "Integrability" characteristics

Multifunctional element	+
Shape & size flexibility	+
Pattern choice	+
Colour choice	+
Joining / frame	+
Availability of dummies	+
Complete construction system	+



Variations of color, © IdeaS Solar

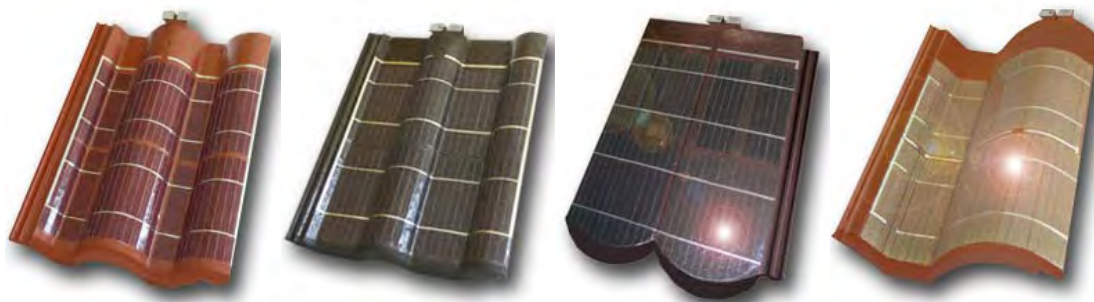

Variations of shape of the tile, © IdeaS Solar





## Quick Step Solar PV

### RheinZink

Ollenhauerstrasse 101, Berlin, D-13403, Germany  
 berlin@rheinZink.de  
<http://www.rheinZink.de>

The design of QUICK STEP-Solar PV is derived directly from the standard QUICK STEP roof covering system produced for years by RheinZink. The perfect compatibility of this product with an existing roof system helps achieve a high level of integration with architecture. QUICK STEP panels fitted with solar modules can be installed on roofs with pitches between 10° and 75° without additional fastening.

### PV "Integrability" characteristics

Multifunctional element	+
Shape & size flexibility	+/-
Pattern choice	+/-
Colour choice	+/-
Jointing / frame	+
Availability of dummies	+
Complete construction system	+



Crystalline silicon cells, matching RHEINZINK® «preweathered<sub>pro</sub>»



Design structure of QUICKSTEP RHEINZINK® Stepped Roof







## COLT Solar Window Shutters

### Colt International

New Lane, Havant, Hampshire, PO9 2LY, UK

ideassolar@t-email.hu

<http://www.coltinfo.co.uk/products-and-systems/architectural-solutions/solar-shading-systems/products/shadovoltaic/>

Colt has developed a Solar Window-Shutter that can be installed on either old buildings during refurbishment, or during the construction process on new buildings. It provides highly efficient external sun shading while generating electricity. It helps optimising the use of daylight and provides thermal protection, burglar protection, and weather protection for windows.

Two parallel lever arms move the Solar Window-Shutter in a half circular movement to the side, so that the solar active side is always pointing towards the sun in either the open or closed position. With wide window formats, the Solar Window-Shutters can be installed as a sliding mechanism. The mechanism is entirely covered by the frame, making the Window-Shutter acceptable for use on historical monuments.

### PV "Integrability" characteristics

Multifunctional element	+
Shape & size flexibility	+
Pattern choice	+/-
Colour choice	+/-
Jointing / frame	+
Availability of dummies	+/-
Complete construction system	+



© Colt



© Colt



© Colt





**SRS Energy Sole Power Tile**

afeinstein@srsenergy.com  
www.srsenergy.com

The SRS Energy Sole Power Tile™ is the first curved solar power product to obtain UL certification and a listing on the California Energy Commission's list of approved solar modules. The Sole Solar Power Tile is specifically designed to replace traditional clay tiles. Due to the thin film laminate the colour is currently limited to dark blue.

**PV "Integrability" characteristics**

Multifunctional element	+
Shape & size flexibility	-
Pattern choice	-
Colour choice	-
Jointing / frame	+
Availability of dummies	+
Complete construction system	+

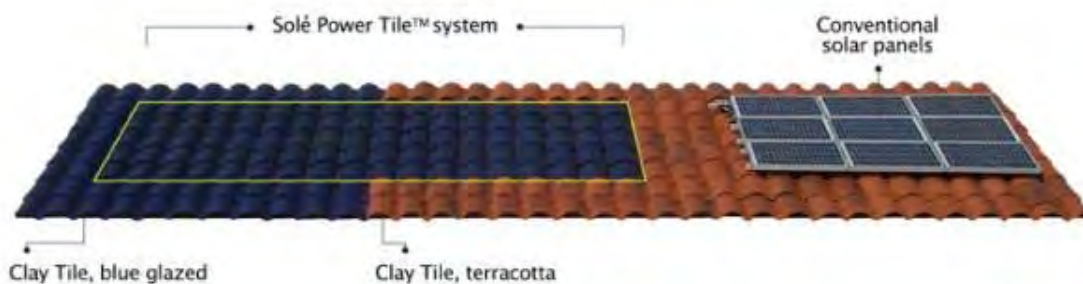

Sole Power Tile system with blue glazed clay tiles, terracotta clay tiles and in comparison with conventional solar panels added on the tiles, © SRS Energy

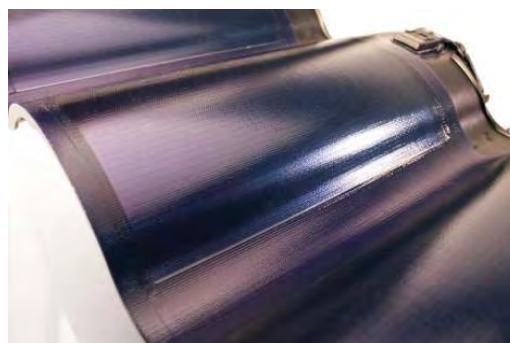

Close-up photos of Sole Power Tile, © SRS Energy







**UNI-SOLAR. Unisolar - Power shingle**

**United Solar Ovonic LLC**  
 3800 Lapeer Road, Auburn Hills, MI 48326, USA  
 info@uni-solar.com  
 www.uni-solar.com

Uni-Solar's Power Shingle is composed of lightweight and flexible laminates integrated and designed to look like traditional asphalt shingles. The shape, size and pattern of the solar laminate imitate standard shingle patterns. The Power Shingle product features laminates that are glass-free and encapsulated in UV-stabilized, weather-resistant polymers.

**PV "Integrability" characteristics**

Multifunctional element	+
Shape & size flexibility	+
Pattern choice	-
Colour choice	-
Jointing / frame	+
Availability of dummies	+
Complete construction system	+



PowerShingle applied on an asphalt shingle roof, UNI-SOLAR, © UNI-SOLAR





## Solar PV Standing Seam and Click Roll Cap System, RheinZink

Ollenhauerstrasse 101, Berlin, D-13403, Germany  
 berlin@rheinZink.de  
 http://www.rheinZink.de

RheinZink-Solar PV for standing seam uses conventional standing seam technology. Uni-Solar modules are fixed full-surface and permanently on RHEINZINK panels. These may be installed without additional fasteners in proven RHEINZINK-seam techniques such as the double lock and/or angled standing seam.

RheinZink-Solar PV for click battens uses conventional roll cap technology: Uni-Solar modules are installed full-surface and permanently on RheinZink-panels. These can be installed on roofs and facades in the RheinZink-Click roll technology without any additional fasteners.

### PV "Integrability" characteristics

Multifunctional element	+
Shape & size flexibility	+
Pattern choice	-
Colour choice	-
Jointing / frame	+
Availability of dummies	-
Complete construction system	+

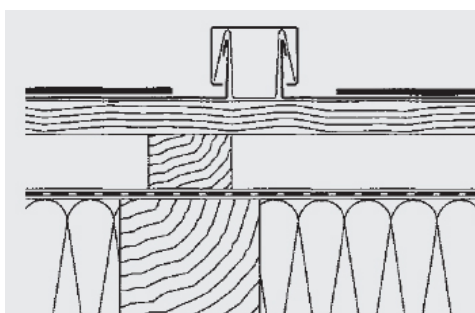

Solar PV Click Roll Cap System, © RheinZink

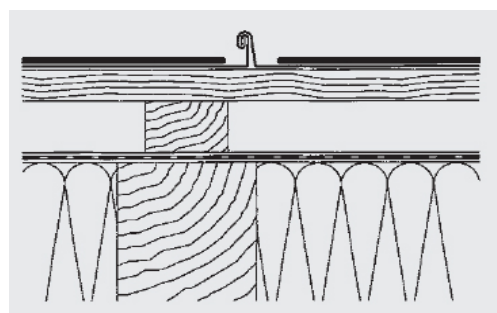

Solar PV Standing Seam System, © RheinZink



Solar PV Click Roll Cap System, © RheinZink



Solar PV Standing Seam System on a curved roof, © RheinZink





**MARCEGAGLIA Marcegaglia, Brollo solar**

Via Bresciani 16, 46040 Gazoldo Ippoliti, Mantova, Italy  
 solar@marcegaglia.com  
 www.marcegaglia.com

The Brollo solar panel is part of a fully integrated roofing system. The thin film photovoltaic module (Uni-Solar) is directly glued on a corrugated metal sandwich, enabling this light weight module to be easily handled and mounted on roofs. Different module dimensions are possible and dummy elements are available. No color choice is offered today by this PV technology. On the other hand, the flexibility of Uni-Solar PV allows installing the modules also on curved metal roofs.

**PV "Integrability" characteristics**

Multifunctional element	+
Shape & size flexibility	+
Pattern choice	-
Colour choice	-
Jointing / frame	+
Availability of dummies	+
Complete construction system	+

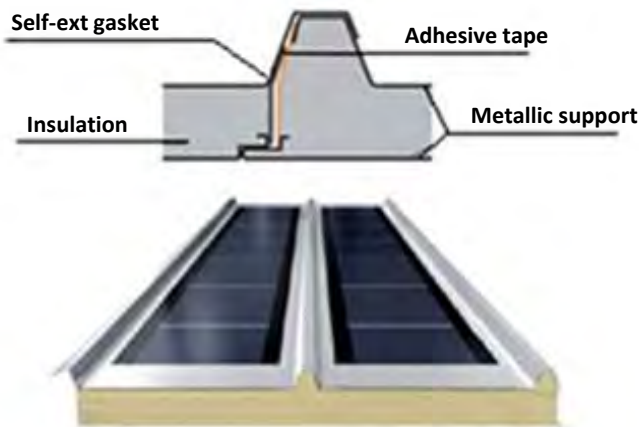

www.marcegaglia.com, © Marcegaglia



Brollo Solar insulated panel,  
 © Marcegaglia



www.marcegaglia.com,  
 © Marcegaglia

www.marcegaglia.com,  
 © Marcegaglia





**flexcell VHF – Technologies, Flexcell**

Rue Edouard-Verdan 2, CH-1400 Yverdon-les-Bains,  
Switzerland  
info@flexcell.com  
www.flexcell.com

The FLX – MO135 module is a lightweight galvanized steel plate with a PV laminate on top. It is specifically adapted for trapezoidal and PVC roofing systems and is suitable for any roof tilt and orientation. The module is provided with a quick-built system which uses the existing roof as backing structure. The FLX – TO135 is an amorphous silicon PV module laminated into a TPO (Thermo-Plastic Polyolefin) roofing membrane designed for flat roof applications. It can be considered a fully integrated solution as it uses the waterproofing layer as substrate. The system is installed as standard waterproofing thermoplastic membranes, either as a single or a double layer system. Due to the adopted PV material (aSi), no colour choice is available (as in the picture). The PV membrane can be easily installed also on curved roofs and on different substrates.

**PV "Integrability" characteristics**

Multifunctional element	+
Shape & size flexibility	+
Pattern choice	-
Colour choice	-
Jointing / frame	n. d.
Availability of dummies	+
Complete construction system	+

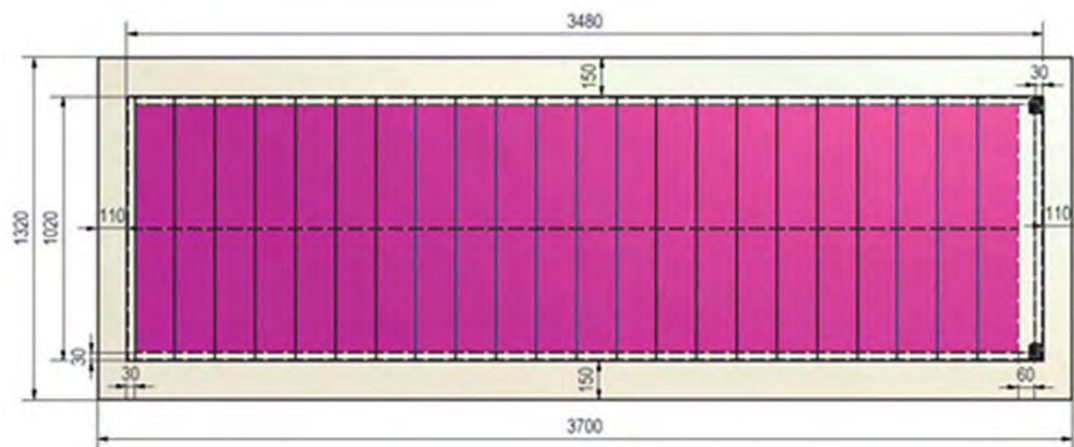

www.flexcell.com, © VHF – Technologies

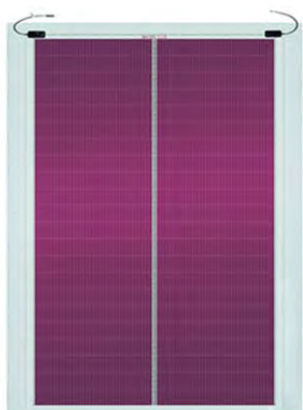

FLX-MO module,  
© VHF – Technologies



FLX-TO Installation - Bellinzona (CH),  
© VHF – Technologies



FLX-MO Installation  
Vigonovo di Fontanafredda (I),  
© VHF – Technologies







**SCHÜCO SCC 60 Ventilated cladding**

**Schüco International KG**  
 Karolinenstraße 1-15, 33609 Bielefeld Germany  
 info@schueco.com  
 http://www.schueco.com

The Schüco ventilated façade SCC 60 (Solar Cladding Construction) integrates Schüco ProSol TF modules. The thin film technology is applicable on opaque façade surfaces in new buildings and renovation projects.

The favourable features of the thin film technology is a higher production in diffuse light and a lower sensitivity to partial shading and high outside temperatures, then crystalline modules. As a result, very high system outputs are achieved per installed kWp.

The Schüco SCC 60 cold façade performs several functions simultaneously, providing high insulation values as well as additional solar energy.

**PV "Integrability" characteristics**

Multifunctional element	+
Shape & size flexibility	+
Pattern choice	+
Colour choice	+
Jointing / frame	+
Availability of dummies	+
Complete construction system	+

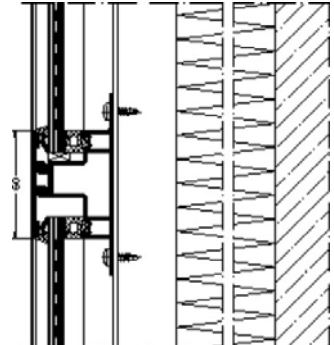
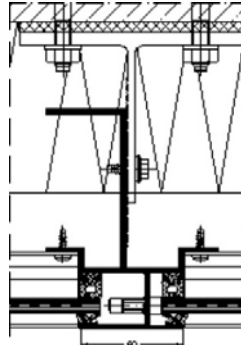

Façade SCC 60 with Schüco façade module ProSol TF



Franhofer Institute, Germany





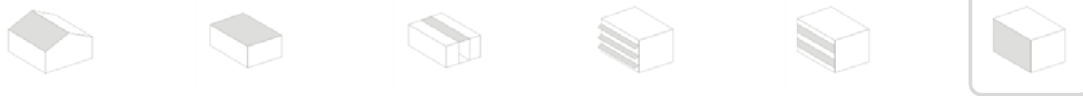

**SOLTECTURE Corium PV façade solution, Soltecture Solartechnik**

Groß-Berliner Damm, 149 – 12487 Berlin (D)  
 info@infosulfurcell.de  
 www.sulfurcell.com

The Soltecture modules are based on the system used for facade cassette cladding. The PV module is applied through an adhesive technology, without any clamping brackets or edge frames. The modules are conceived as multifunctional elements, for electrical energy production and façade cladding. Behind the cassette system, there is a ventilation channel that contributes to cooling down the PV modules and prevents interstitial condensation as well. The PV modules have standard dimensions but other sizes are available on request, as for the dummy cassettes. The modules are proposed for façade integration of residential, industrial and commercial buildings, forming a homogenous glass surface.

**PV "Integrability" characteristics**

Multifunctional element	+
Shape & size flexibility	+
Pattern choice	-
Colour choice	-
Joining / frame	+
Availability of dummies	+
Complete construction system	+

Module standard size: 1250 mm x 650 mm. Weight: 20 kg Thickness: 85 mm

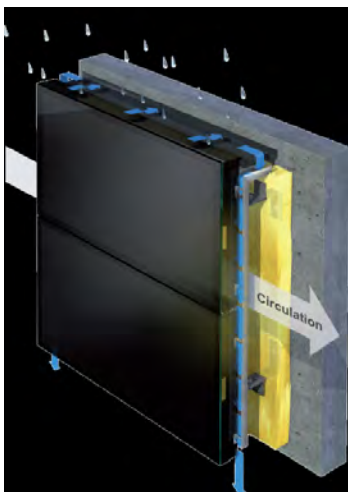
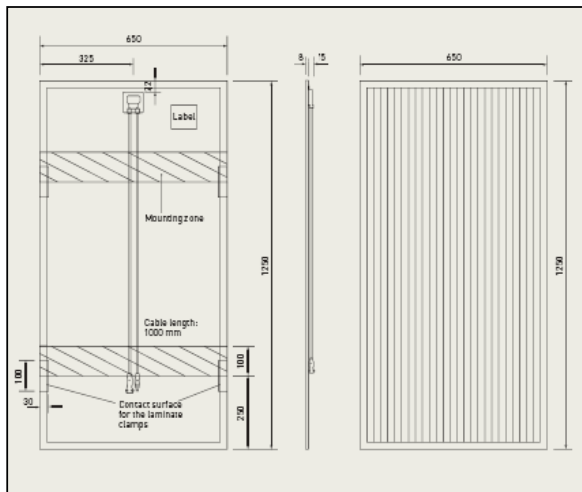

Photo: Soltecture GmbH







**SCHÜCO ProSol TF**

**Schüco International KG**  
 Karolinenstraße 1-15, 33609 Bielefeld Germany  
 info@schueco.com  
 http://www.schueco.com

As thermal insulating glass in windows and curtain wall façades, Schüco ProSol TF takes on the central functions of the building envelope. It brings together solar shading, weather resistance, sound reduction, thermal insulation and energy generation in a single building component. ProSol TF is suitable for use as semi-transparent thermal insulating glass or opaque glazing in the spandrel area. The amorphous thin-film technology makes complex, homogenous surfaces possible. Degrees of transparency up to 30% can be achieved by means of laser cutting, thereby creating a close visual connection with the surroundings. Laser cutting can also be used to generate patterns and textures.

**PV "Integrability" characteristics**

Multifunctional element	+
Shape & size flexibility	+
Pattern choice	+
Colour choice	+
Jointing / frame	+
Availability of dummies	+
Complete construction system	+

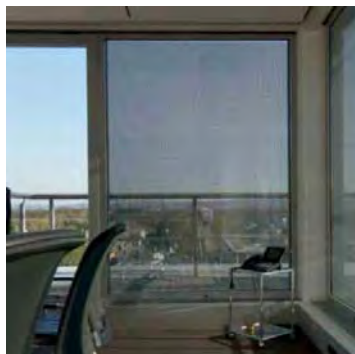
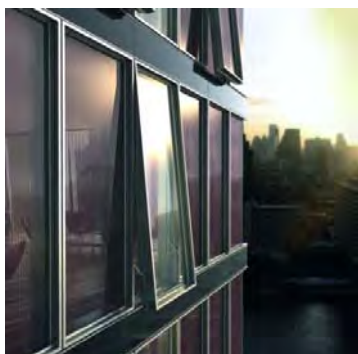
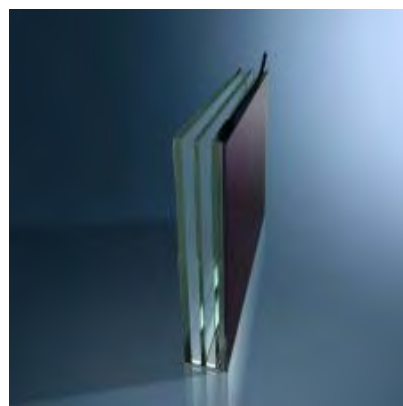





**Schott AG, ASI THRU, ASI OPAK**

Hüttenstrasse 1, 31073, Grünenplan, Germany  
 Info.architecture@schott.com  
 www.schott.com/architecture

ASI® Glass elements can fulfill many requirements of building envelopes and are available in various design options. The system can be used for many applications. They can be semi-transparent (THRU) or non-transparent (OPAK). The elements are available as both laminated glass and as double glazing unit, which can be combined with many types of conventional framing systems.

Static load requirements can be met by changing the type and thickness of the glass panes. The ASI® solar cells are encapsulated with laminated foils. In addition to a large number of standard types and sizes, customised solutions can also be provided.

ASI® Glass elements can contribute to the minimisation of heat gain in summer (reduction of the total heat gain coefficient) and, thermal loss in winter, when included in high performance windows. Different foils as coating can be used in order to change the colour of the front or the back glass. Glare remains an issue.

**PV "Integrability" characteristics**

Multifunctional element	+
Shape & size flexibility	+
Pattern choice	+
Colour choice	+
Jointing / frame	+
Availability of dummies	+
Complete construction system	+

**Module options with ASI® Glass**



www.schott.com, © Schott AG



ASI-THRU® & ASI-OPAK® modules, © Schott AG

Double roof glazing: primary school Munich 2002 © Schott AG

Solar facade SCHOTT Ibérica Barelona 2005 © Schott AG







**Würth Solar**  
 Alfred-Leikam-Straße 25, 74523 Schwäbisch-Hall, Germany  
 wuerth-solar@we-online.de  
 www.wuerth-solar.de

GeneCIS are multilayered CIS (Copper-Indium-Diselenide) modules which are suitable for all fields of application and sizes of solar energy systems. They are characterized by a homogeneous black module surface. Due to their appearance, the modules are suitable for incorporating architectural designs. These modules can be provided in a wide range of sizes, form and power output. They are also delivered in a glass/glass compound with or without a frame. The availability of different patterns and different module transparencies, combined with the possibility to choose different background colours and/or printed shaping, open the way for an unlimited palette of design solutions.

**PV "Integrability" characteristics**

Multifunctional element	+
Shape & size flexibility	+
Pattern choice	+
Colour choice	+
Jointing / frame	+
Availability of dummies	+
Complete construction system	+

Different patterns and different colours are available

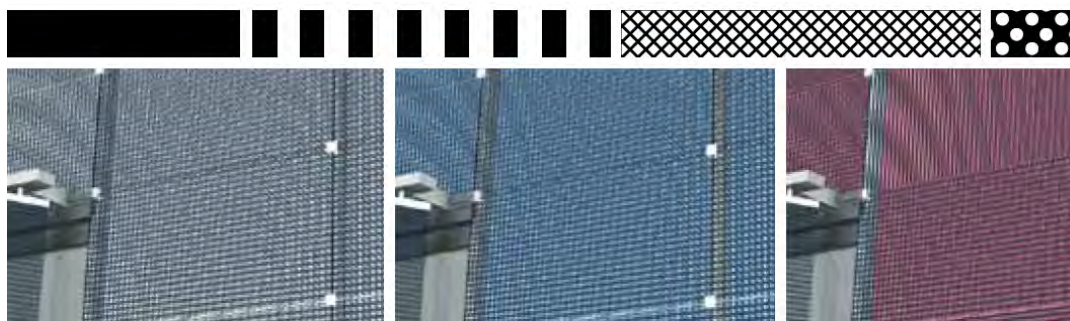





**KYOSEMI Sphelar®**, Kyosemi

949-2 Ebisu-cho, Fushimi-ku, Kyoto-shi, 612-8201 Japan  
 info@kyosemi.co.jp  
 www.kyosemi.co.jp

Sphelar® are spherical solar cells produced by Kyosemi Corporation (each cell measures 1-2 mm) and their main characteristic is that both sides generate electricity wherever the light source is located.

The cells can be integrated in different low power applications, but also in see-through solar modules, which are custom-made. The transparency of the modules can vary from 20 to 80% and varied shapes are available from curved surface to pliable sheet. The product needs further development, in order to have some standardized products for building integration.

**PV "Integrability" characteristics**

Multifunctional element	+
Shape & size flexibility	+
Pattern choice	+
Colour choice	-
Joining / frame	+
Availability of dummies	-
Complete construction system	-

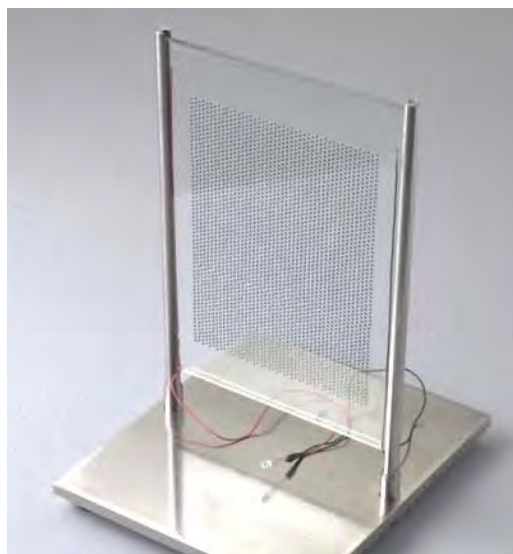
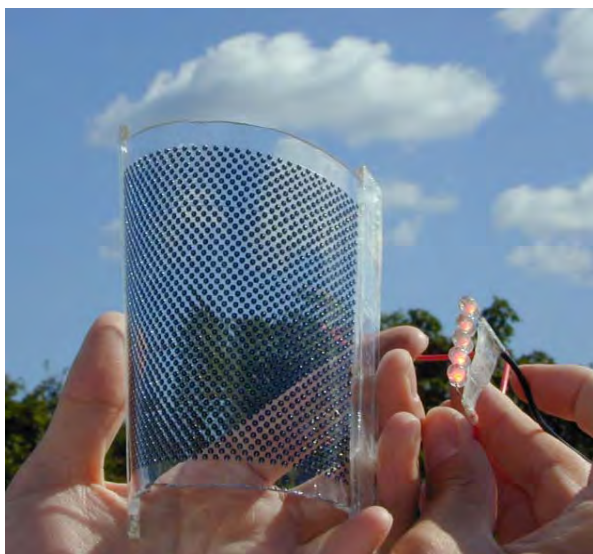

Sphelar spherical solar cells, © Kyosemi





## Solar Tile Curtain

### Astrid Krogh

Sturlasgade 14 D  
 2300 Copenhagen, Denmark  
 info@astridkrogh.com  
 www.astridkrogh.com

The Sun Tiles by industrial designer Astrid Krogh, Risø DTU, Schmidt, Hammer & Lassens Architects and Esbensens Rådgivende Ingeniører is a solar curtain that not only blocks solar heat but also acts as a renewable energy generator. The concept features photovoltaic modules that are woven into textile. The polymer cells are also sensitive to diffuse light and are therefore suitable in the interior.

These curtains collect energy to generate power, block solar heat and also act as a thermal mass, which heats the building interiors when it is cold outside.

Due to its low initial costs but also low durability and low efficiency, these curtains are suitable for office buildings, where there is a need for shading devices in large surfaces.

### PV "Integrability" characteristics

Multifunctional element	+
Shape & size flexibility	+
Pattern choice	-
Colour choice	-
Jointing / frame	+
Availability of dummies	+
Complete construction system	+

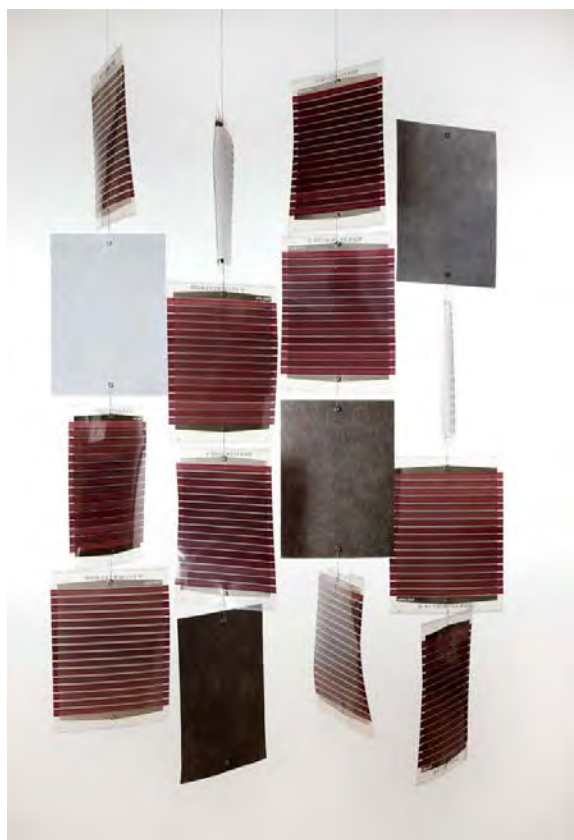

Solar Tile Curtain, © Astrid Krogh





## SMIT Solar Ivy, SMIT

63 Flushing Ave, Unit 195, Building 280, Suite 515, Brooklyn, NY 11205  
 contact@s-m-i-t.com  
 www.s-m-i-t.com

Solar Ivy is a solar energy system conceived by the SMIT team and inspired by the natural growth of ivy on buildings and in nature.

Solar Ivy consists of flexible photovoltaic leaves made of sheets of recyclable polyethylene; it is modular and it is proposed to be used on building facades to capture the sunlight in the similar way plants do.

Different colours are available to meet aesthetic and building integration needs.

Data regarding the energy production are not available yet.

GROW represents the new version of Solar Ivy and was featured in the exhibit at the Museum of Modern Art in NY in 2008.

### PV "Integrability" characteristics

Multifunctional element	+
Shape & size flexibility	+
Pattern choice	+
Colour choice	+
Joining / frame	+/-
Availability of dummies	-
Complete construction system	-



Photo: s-m-i-t.com

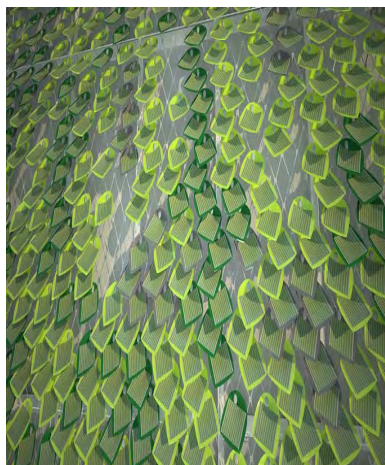





## References and further reading:

- [3-B.1] <http://sunbird.jrc.it/pvgis/apps/pvest.php>
- [3-B.2] L. Fanni et al., Maximum production conditions of a c-Si module in three different Italian locations, in proceedings of the 26th European Photovoltaic Solar Energy Conference, Hamburg 2011.
- [3-B.3] Groppi, F., & Zuccaro, C. (2007). Impianti solari fotovoltaici a norme CEI, guida per progettisti e installatori. Milano: Editoriale Delfino.
- [3-B.4] L. Maturi et al., Analysis and monitoring results of a BIPV system in Northern Italy, in proceedings of the 25th European Photovoltaic Solar Energy Conference, Hamburg 2010.
- [3-B.5] Chatzipanagi A., Frontini F. et al.: Evaluation of 1 year of monitoring results of a testing stand for Building Integrated PV elements. In: Proceedings 26th EUPVSEC. Hamburg 2011.
- [3-B.6] Scognamiglio, A., Bosisio, P., Di Dio, V., Milano, 2009. Fotovoltaico negli edifici, Edizioni Ambiente, ISBN 978-88-96238-14-1
- [3-B.7] Schittich C., Shell, Skin, Materilas. In: Schittich, C., (Ed.), Building Skins – Concepts, Layers, Materials, Birkhauser (2001), Edition Detail, pp.8-27
- [3-B.8] Svensson, O. and Wittchen, K.B., Aesthetics of PV building integration, 2004. Final report, PV Nord, Göteborg, Sweden
- [3-B.9] Farkas, K., Andresen, I., Hestnes, A.G., Architectural Integration of Photovoltaic Cells, Overview of materials and products from an architectural point of view, SASBE 2009, The Hague, The Netherlands, June 2009
- [3-B.10] Weller B. et al, 2010. Photovoltaics, Technology, Architecture, Installation, Birkhäuser, Edition Detail, Munich
- [3-B.11] Simon R. and Guriento N., 2009. Building Integrated Photovoltaics/a handbook, Birkhäuser, Basel-Boston-Berlin
- [3-B.12] The German Solar Energy Society. (2005). Planning and Installing Photovoltaic Systems. London: James and James Publishers.
- [3-B.13] Arvind Shah. Thin-Film silicon Solar Cells, EPFL Press (2010)
- [3-B.14] Swiss BIPV Competence Center, Photovoltaic material, <http://www.bipv.ch>, 2011
- [3-B.15] CLC/TC 82, Solar photovoltaic energy systems, [http://www.cenelec.eu/dyn/www/f?p=104:7:3621654491259393:::FSP\\_ORG\\_ID:989](http://www.cenelec.eu/dyn/www/f?p=104:7:3621654491259393:::FSP_ORG_ID:989)
- [3-B.16] F. Frontini, Daylight and Solar Control in Buildings: General Evaluation and Optimization of a New Angle Selective Glazing, PhD Thesis, Politecnico di Milano, 2009, Fraunhofer Verlag, ISBN 978-3839602386
- [3-B.17] F. Frontini, T.E. Kuhn, A new angle-selective, see-through bipv façade for solar control, Eurosun Conference 2010, Graz, September 2010.
- [3-B.18] C. Roecker, P. Affolter, A. Muller, and F. Schaller Demosite : The Reference for Photovoltaic Building Integrated Technologies In *17th European Photovoltaic Solar Energy Conference - Munich*, 2001.
- [3-B.19] C. Roecker, F. Schaller, F. Leenders, A. J. N. Schoen, R. Noble, and R. D. W. Scott, PV en Face ! The Development of Low-Cost High-Quality Façade Elements  
In 16th European Photovoltaic Solar Energy Conference and Exhibition, Glasgow, UK, 2000.
- [3-B.20] MC. Munari Probst, C. Roecker, Building Integration of Solar Thermal and Photovoltaics: Differences and similarities., CISBAT 2009, Lausanne
- [3-B.21] Luque A., Hegedus S., Handbook of photovoltaic science and engineering, Wiley, ISBN 0-471-49196-9, 2003
- [3-B.22] Scognamiglio A., Privato C., Starting points for a new cultural vision of BIPV, Proceedings of the 23rd European Photovoltaic Solar Energy Conference, Valencia, Spain, 1-5 September 2008, pp.3222-3233, ISBN 3-936338-24-8
- [3-B.23] I. B. Hagemann, Perspectives and challenge of BIPV product design, 26th EUPVSEC Proceedings, ISBN 3-936338-27-2, p. 4018
- [3-B.24] A. Scognamiglio, G. Graditi, F. Pascarella, C. Privato, Boogie-Woogie, a photovoltaic glass-glass module “dancing” with the building, Proceedings of the 21st European Photovoltaic Solar Energy Conference, Dresden, Germany, 4-8 September 2006, pp. 2853-2856, ISBN 3-936338-20-5; R
- [3-B.25] R. Baum, Architectural integration of light transmissive Photovoltaic (LTPV), 26th EUPVSEC Proceedings, ISBN ISBN 3-936338-27-2, pp. 3967-3976.
- [3-B.26] Bernhard Weller. et al. Detail Practice: Photovoltaics, ed. Detail, 2010, ISBN 978-3-0346-0369-0
- [3-B.27] Prasad, D. and Snow, M.,(eds) Designing with Solar Power. A source book for building integrated photovoltaics (BIPV). 2005 ISBN 1-844071-47-2.



## **4. PHOTOVOLTAICS VS SOLAR THERMAL: VERY DIFFERENT BUILDING INTEGRATION POSSIBILITIES AND CONSTRAINTS**

*MC. Munari Probst, C. Roecker - adapted from a paper presented at CISBAT 2009 [4.1]*

### **4.1. INTRODUCTION**

The ever increasing interest for renewable energies results in a constantly growing market demand for active solar systems, both for electricity (photovoltaics) and for heat production (solar thermal).

This trend, added to the new promotion policies recently set up by the EU, let foresee an increased interest for all the sun exposed building surfaces, resulting in a new debate on how to optimize their use for the production of solar electricity and/or solar heat.

Although similarities in the integration on the building envelope of solar thermal and photovoltaic systems do exist, there are also major differences that need to be considered. Both technologies deal with the same building skin frame, and have similar surfaces and orientations needs. On the other hand they have different intrinsic formal characteristics, different energy transportation and storage issues, different insulation needs, shadow influence, etc...

The impact these technology peculiarities have on the building implementation possibilities are described here to support making the best use of the available exposed building surfaces.

### **4.2. COMPLEMENTARITY ELEMENTS**

Solar thermal and photovoltaics are complementary and equally crucial technologies to minimize a building fossil fuel energies consumption and related CO<sub>2</sub> gas emissions: PV is needed to produce the electricity for appliances and artificial lighting, solar thermal is needed to provide heat for DHW and can be used for space heating (in the near future also for cooling) (Tab.1) (see also ch.1-Introduction, page3).

BUILDING ENERGY NEEDS	CORRESPONDING SOLAR TECHNOLOGIES	
	PASSIVE	ACTIVE
SPACE HEATING	PASSIVE SOLAR	SOLAR THERMAL
DOMESTIC HOT WATER	-	SOLAR THERMAL
ELECTRIC APPLIANCES	-	PHOTOVOLTAICS
LIGHT	DAYLIGHTING	PHOTOVOLTAICS
(SPACE COOLING)	(FREE COOLING)	(SOLAR THERMAL / PV)

Fig 4.1: Building energy needs and corresponding solar technologies

As both PV modules and solar thermal collectors produce energy from the sun and need to be placed on the sun exposed areas of the building skin, the issues related to their integration in the building envelope are often treated together, assuming they are part of a unique problematic. This simplification may be acceptable for very small solar systems and where the needed surfaces are much smaller than the exposed areas actually available. But in most cases, to optimize the use of the available - finite- exposed surfaces; the specificities of each technology should be taken into account, especially in buildings with high solar fractions.

Photovoltaics and solar thermal are fundamentally different, as one is designed to transform the solar radiation into electricity, and the other is designed to transform it into heat: two different energies, with very different transportation and storage issues. This brings different formal and operating constraints, leading to different building integration possibilities.

To help architects implement both types of systems while using optimally the sun exposed surfaces of their buildings, we will analyse the ways the characteristics of these two technologies affect building integration (see ch.2 Architectural integration quality, page 6).

### 4.3. SIGNIFICANT COLLECTORS FORMAL CHARACTERISTICS

Both fields of solar thermal and PV count several technologies interesting for building integration: monocrystalline, polycrystalline and thin films in the field of PV; glazed flat plates, unglazed flat plates and vacuum tubes collectors in the field of solar thermal. Unless differently specified, the following considerations refer to the most diffused ones in EU, i.e. crystalline -mono and poly- cells for PV and glazed flat plate collectors for solar thermal.

To keep the message clear and short, distinctions will be made only when considered important. For a detailed description of Solar Thermal and Photovoltaic technologies please refer respectively to ch.3-A and ch. 3 B of the present document.

#### 4.3.1 Shape, size, flexibility

The basic shape, size and dimensional flexibility of the PV modules are fundamentally different from the ones of thermal collectors.

The size and shape of PV modules are very flexible since they result mainly from the juxtaposition of single squared silicon cells (mono or polycrystalline) of approximately 12 to 15cm side. Modules can come in the size of less than 0.1m<sup>2</sup> (few cells) up to 2m<sup>2</sup> (more than 60 cells). Thanks to the flexibility of the internal connexions and the small cells' size, made to measure module can be provided in almost any shape (at a higher price in this case). Moreover the possibility of partial transparency is offered through glass-glass modules. Thin films modules can also offer a new level of freedom when using flexible metal or plastic sheets.

Solar thermal collectors are much bigger (1.5 to 3m<sup>2</sup>) and their shape definitely less flexible. This derives mainly from the need of a non flexible hydraulic circuit fixed to the

solar absorber to collect the heat: the freedom in module shape and size would require reconsidering every time the hydraulic system pattern, which is generally difficult and expensive. The lack of market demand for architectural integration is also a cause of this poor offer up to recently. The case of evacuated tubes is different: the panel size and shape result from the addition of evacuated tubes: length from 1 to 2m, diameter from 6 to 10cm. In most cases though, only standard modules are available.

***Impact on building integration***

*Ideally, the shape and size of the solar module should be compatible with the building composition grid and with the various dimensions of the other envelope elements. The lack of flexibility associated to the large size of solar thermal collectors reduces significantly the possibilities of proper implementation. The higher shape and size flexibility of photovoltaics modules and their small size make it easier to deal with both new and pre-existing buildings. These different flexibilities imply very different constraints when choosing the shape and placement of the collectors' field(s), especially for façade integration.*

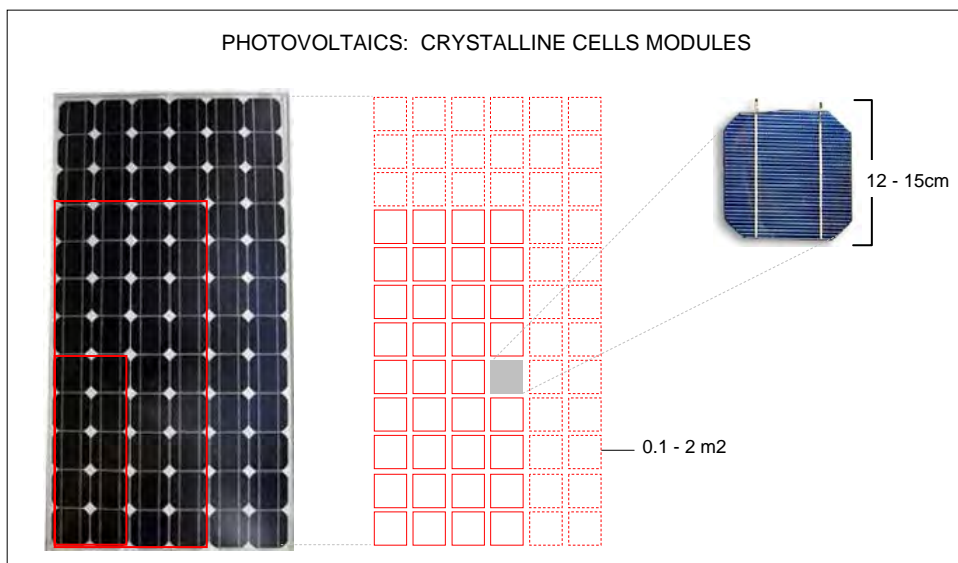

Fig. 4.2: shape and size flexibility of crystalline photovoltaic modules

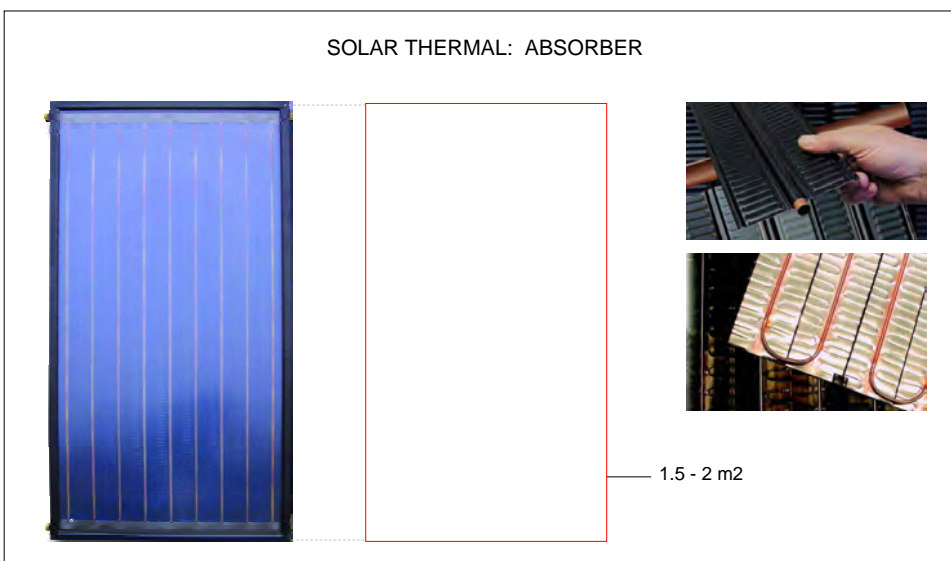

Fig. 4.3: typical low flexibility in size of standard glazed flat plates collectors

### 4.3.2 Module structure, thickness, weight

The thickness and weight of PV and solar thermal modules are also totally different. PV modules are thin (0.4 to 1cm) and relatively light (9-18 kg/m<sup>2</sup>), while solar thermal ones are much thicker (4 to 10 cm) and heavier (around 20 kg/m<sup>2</sup>).

PV mainly consists in thin laminated modules encapsulating the very thin silicon cells layer between an extra white glass sheet (on top) and a composite material (Tedlar / Mylar) or a second sheet of glass.

Solar thermal collectors are composed by multiple layers in a sandwich structure: glass sheet / air cavity / metal absorber / hydraulic system / insulation. Evacuated tubes have a different structure: an absorber core protected and insulated by a glass tube.

#### Impact on building integration

The difference of weight between the two types of modules presents mainly different characteristics in handling (1 person vs. 2 persons for the mounting), but does not have a relevant impact on the under construction structure.

The thickness on the contrary does affect the integration possibilities, especially in facades. While the thinner PV modules can be used as sun shading on facades, and easily implemented as a cladding, the thickness of solar thermal makes the sun shading application problematic and the use as cladding more delicate, especially in retrofits. This is also true, on a lesser degree, for the roof applications.

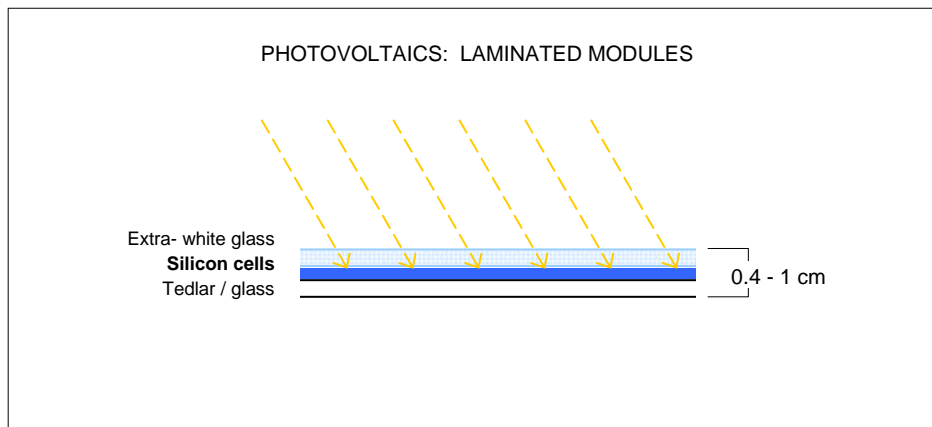

Fig 4.4: Low thickness characterizing of photovoltaic modules

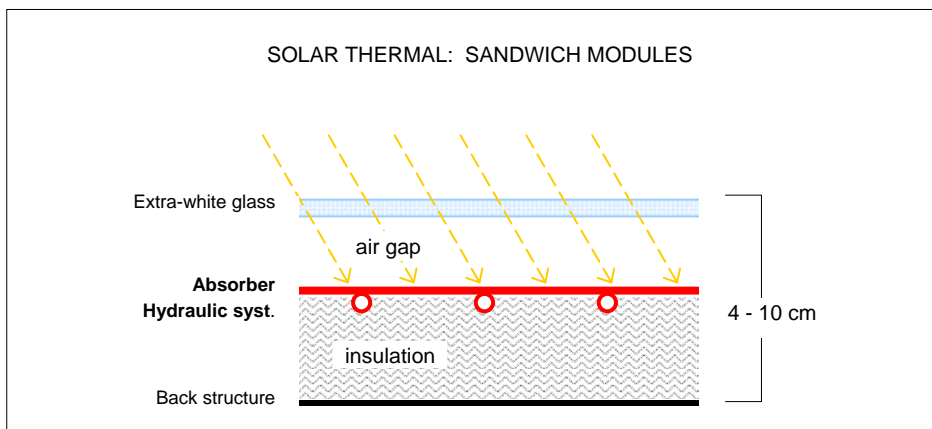

Fig 4.5: Thickness of standard glazed flat plate collectors

### 4.3.3 Visible materials / surface textures / colours

The external layer of both PV and solar thermal modules consists in a sheet of extra white glass. The glass surface can be smooth, textured or acid etched, but always lets see the internal layer: the silicon cells in PV, the metal absorber in solar thermal.

The structure, the geometry and the appearance of these layers are very different: the metal absorber of solar thermal collectors is generally continuous and covers the whole module area, while for PV the cells can be arranged in different patterns, also playing with their spacing.

PV crystalline cells have a flat surface, mainly blue or black, with a squarish shape. The absorbers of thermal collectors are characterized by a more or less corrugated metallic surface, coated in black or dark blue.

Evacuated tubes are different, as described in section 3.2 of the present chapter.

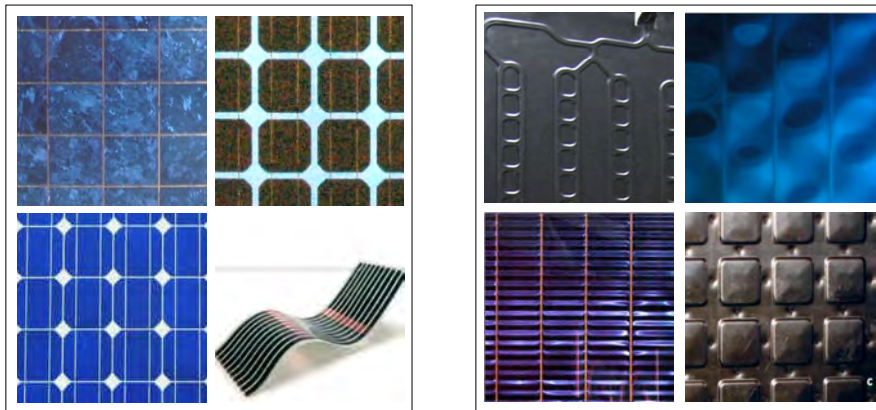

Fig 4.6 and 4.7: Visible surface colours and textures of PV modules (left) and ST collectors (right)

#### Impact on building integration

*Due to the above described characteristics of their absorbers, flat plate thermal collectors can be implemented only on opaque areas of the building envelope (roof or facades), while PV modules can be mounted also on transparent ones. When mounted in a glass/glass module, the cells can be freely spaced with a resulting variable module transparency, well adapted for atrium / veranda/ sheds or glazed facades applications.*

*The structure of evacuated tubes could allow the mounting on the transparent envelope areas, as sun shading for instance. This type of application is very rare though, due to the lack of products developed for this specific use.*

## 4.4. ENERGY TRANSPORT AND STORAGE

As PV modules produce electricity and solar thermal produces heat, they have to deal with different energy transportation, storage and safety issues.

### 4.4.1 Energy medium and transport

Electricity can be transported easily and with very small losses through thin (0.8-1.5cm diameter), flexible electric cabling. It can then be easily transported over long distances, so that the energy production doesn't need to be close to the consumption place.

Heat is transported by water (charged with glycol to avoid winter freezing) through the rigid piping of the hydraulic system. Heat transportation is very sensitive to losses, meaning on one hand that the piping system has to be very well insulated (resulting diameter: 3 to 8cm), on the other hand that the heat should be used near the production place.

### Impact on building integration

Compared to the small size and flexibility of electrical cables, the rigidity, size and need for insulation of solar thermal piping requires much more space (and planning care) to be accommodated in the building envelope.

The different types of energy transport bring also different building safety measures: preventing water leakage damages for solar thermal, preventing fire propagation for PV. Water pressure issues should also be considered when dimensioning the solar thermal system, in particular when defining the vertical field size. But the fundamental difference rising from the different transport issues is that while solar thermal needs to be installed close to the place where the heat is needed, PV can be installed anywhere, even very far from the consumption place. This should be taken into consideration when working on sensible urban areas, like historical city centres or protected buildings.

### **4.4.2 Energy storage**

Because of the different ways these energies can be transported, their storage issues are radically different, affecting strongly the implementation possibilities.

The electricity produced by the PV modules can be injected practically without limits into the grid. As a result the sizing of the system is totally independent from the local consumption and the energy produced can exceed by far the building electricity needs.

On the contrary, the heat produced by thermal collectors has to be stored close to the consumption place, usually in the building storage tank. In practice, the storage capacity of the water tank is limited, usually offering no more than a few days autonomy. Furthermore, solar thermal collectors are sensitive to damages resulting from overheating, so that ideally the heat production should not exceed the storage capacity.

### Impact on building integration

The sizing principles of the two types of systems are completely different: Solar thermal systems should be dimensioned according to the specific building needs and to the storage tank capacity, to avoid overproduction and the accompanying overheating problems.

PV is totally independent from the building energy needs and can be dimensioned just according to the size of available exposed areas, or according to architectural criteria for instance.

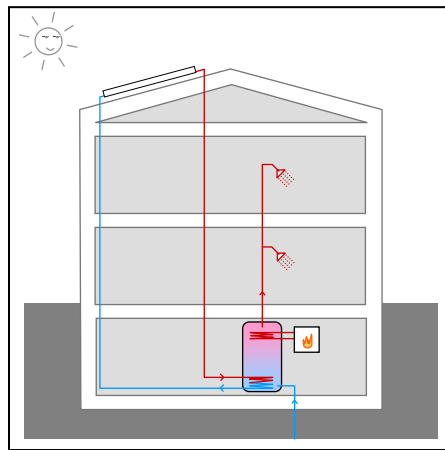

Fig. 4.8 (left): Public grid for electricity transport and storage

Fig. 4.9: Typical hot water storage system in insulated tank placed in the building itself (limited storage volume).



## 4.5. OPERATING CONSTRAINTS

### 4.5.1 Operating temperatures and related insulation needs

Suitable operating temperatures are again different between the two technologies: for PV, especially for crystalline cells, the lower the operating temperature, the better; for solar thermal, the higher the better (still avoiding overheating).

#### *Impact on building integration*

*This difference affects once more the integration possibilities in the building envelope: PV modules should be back ventilated for a higher efficiency; solar thermal absorbers require back insulation to minimize heat losses. Integrating the collectors directly in the building envelope layers, possibly without air gap, is ideal in this sense for solar thermal, while freestanding or ventilated applications would be preferable for PV.*

### 4.5.2 Shadows

#### *Impact on building integration*

*For solar thermal, the heat losses resulting from partial shadowing are just proportional to the shadow size and don't cause any particular production or safety problem. Photovoltaics on the other hand can be very sensitive to partial shadowing: the electricity production may be greatly affected by partial shadows if special care is not given to the modules placement and string cabling. The energy losses are generally higher than the shadow ratio, with possible risks of modules damage if its impact is not well considered during the system design phase.*

## 4.6. CONCLUSIONS

As shown above, there are clear differences in the characteristics of solar thermal and photovoltaics systems, leading to different approaches when integrating them in the building envelope. A synthetic overview is presented in the table below (fig. 4.11).



Fig. 4.9 (left) and 4.10 (right): photovoltaic products (left) and solar thermal products on the market.

Several considerations can be derived from these observations, which cannot all be presented here.

		PHOTOVOLTAICS *	SOLAR THERMAL**
FORMAL CHARACTERISTICS	MODULE SIZE	0.1 to 2m <sup>2</sup>	1.5 to 3m <sup>2</sup>
	SHAPE / SIZE FLEXIBILITY	High flexibility	Low flexibility
	THICKNESS	0.4 cm to 1 cm	4 to 10 cm
	WEIGHT	9-18 kg/m <sup>2</sup>	20kg/m <sup>2</sup>
	MODULE STRUCTURE	laminated modules	sandwich modules
	MATERIALS	Glass / silicon cells / Tedlar -Mylar or glass	Glass / air / metal absorber / hydr.system / insulation
	SURFACE TEXTURES	External glass: smooth / acid etched / structured. Silicon cells: variable patterns, possible transparency	External glass: smooth / acid etched / structured. Absorber: slightly corrugated, opaque metal sheet
	COLOURS	Black / blue mainly.	Black / dark blue mainly
TECH. CHARACTERISTICS	ENERGY MEDIUM	Electricity	Hot water
	ENERGY TRANSPORT	Flexible cabling (0.8-1.5 cm diameter). Low energy losses.	Rigid insulated piping system (3-8 cm diameter). High energy losses.
	ENERGY STORAGE	Presently unlimited, into the grid	Limited to building needs / storage capacity of the building tank.
	WORKING TEMP.	The lower the better (back <u>VENTILATION</u> required)	The higher the better (back <u>INSULATION</u> required)
	SHADOWS IMPACT	Reduction in performances higher than shadow ratio; risks of permanent damage to the panel.	Reduction of performances proportional to shadow size, no damage to the panel.
	ENERGY PRODUCTION	80- 120 kWh/m <sup>2</sup> per year	450-650 kWh/m <sup>2</sup> per year
	COST (CH – 2009)	300.- to 450.- €/m <sup>2</sup>	300.- to 450.- €/m <sup>2</sup>

\* valid for crystalline cells

\*\*valid for glazed flat plate collectors

Fig 4.11: Formal and technical characteristics of Photovoltaics and Solar Thermal. (Please remember that the two technologies are not interchangeable, hence are not competing against each other: both are equally needed as they cover different building needs)

It is important to underline one major outcome that concerns the positioning options induced by the different storage constraints:

As there are presently no limitations in the storage of the energy produced by PV, its annual energy production should be optimized by locating and orienting the PV where its sun exposure is maximized (tilted or flat roofs mounting in most cases) (cfr. 4.4, and ch.3.B p.59-62).

This brings one interesting option for solar thermal integration. In EU mid latitudes, where the solar radiation varies dramatically during the year, the maximum summer production can be twice the winter one. To avoid summer overheating, tilted solar thermal systems are usually undersized (solar fractions around 50%). A good way to increase the whole year solar fraction while limiting overheating risks is to mount the collectors vertically, using the facade areas. The heat production would then be almost constant during the year, making it possible to dimension the system according to the real needs (Fig.1). This allows solar fraction of up to 90%, while opening the way to building facades use (ref. ch.3A.2, page18).

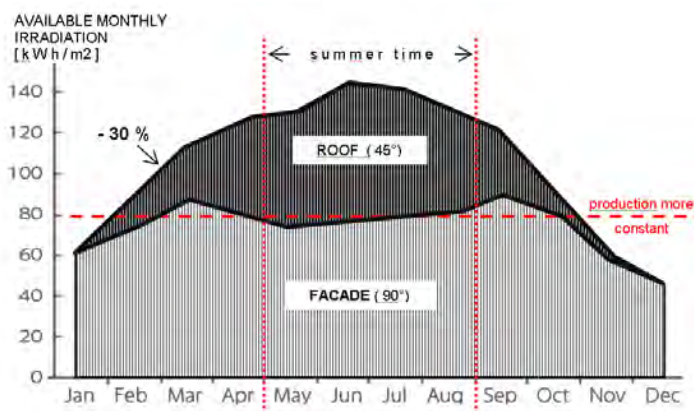

Fig. 4.12: Comparison of the monthly sun radiation available on a 45° south oriented tilted surface vs. a vertical south oriented surface in Graz, Austria (47° latitude). Data from W.Weiss, I.Bergmann, AEE-Intec.

However, if for photovoltaics there is a large offer of products suitable/conceived for building integration, exploiting the flexibility of the technology, the situation is different for solar thermal. The big size of most collectors now available, their lack of dimensional flexibility as well as the dark irregular appearance of their absorber makes it difficult to integrate solar thermal, particularly on facades. This is an issue that should be solved urgently, especially in the light of the previous considerations:

New solar thermal products conceived for building integration should be developed, matching the offer available in the PV field, to help answer to the booming demand for architectural integration of solar in buildings.

This is even more important considering the high efficiency and cost effectiveness of this technology.

#### References

- [4.1] MC Munari Probst MC, C Roecker, Photovoltaic vs. Solar Thermal: very different building integration possibilities and constraints ,in proceedings Cisbat 2009, Lausanne, Switzerland, 2009.
- [4.2] A Renewable Energy Roadmap: paving the way towards a 20% share of renewables in the EU's energy mix by 2020, EU MEMO/07/13, Brussels 10.01.2007

- [4.3] W. Weiss Editor "Solar Heating systems for Houses - A design handbook for solar combisystem"-James and James 2003.
- [4.4] MC.Munari Probst, C.Roecker, Towards an improved architectural quality of building integrated solar thermal systems, in SolarEnergy (2007) doi:10.1016/j.solener.2007.02.009
- [4.5] MC. Munari Probst, Architectural integration and design of solar thermal systems, PhD thesis n. 4258, EPFL, Switzerland, December 2008.
- [4.6] C.Roecker; P. Affolter; A. Muller, F.Schaller, Demosite : The Reference for Photovoltaic Building Integrated Technologies, 17th European PV Solar Energy Conference, Munich 2001
- [4.7] Ingo B. Hagemann "Gebäudeintegrierte Photovoltaik – Architektonische Integration der Photovoltaik in die Gebäudehülle", Ed. Rudolf Müller 2002.
- [4.8] IEA, SHC Task 41- Solar Energy and Architecture, Annex plan, December 2008.
- [4.9] MC Munari Probst, C Roecker, Architectural integration and design of solar thermal systems, PPUR -Routledge, Taylor&Francis, 2011

## 5. CONCLUSIONS

As seen in the previous chapters, good knowledge in three key topics is needed to properly integrate photovoltaics and solar thermal systems into architecture:

- Knowing the different energetic specifications of solar thermal and photovoltaic technologies;
- Understanding the respective system dimensioning principles, with their cross dependences from technology, orientation, building needs and storage possibilities;
- Knowing the formal properties of existing products, with their features and limitations, to best use their characteristics in a project;

Upcoming improvements in both the dimensioning and the products integrability domains should help more and more professionals access this knowledge:

On one hand, new smart software tools for architects simplify the study of solar systems variants in the early design stage of projects, when a smooth integration process is easiest as freedom is maximized (see report T41.B.2 of Task 41 "International survey about digital tools used by architects for solar design").

On the other hand, thanks to the growing interest of architects for solar use, manufacturers are becoming much more aware of the need for new products specially adapted to architectural integration, or at least for an increased flexibility in their existing products, leading to novel development activities also in the less developed field of solar thermal integration (see reports T41.A.3/1 and T41.A.3/2 of Task 41 "Designing solar systems for architectural integration").



# ANNEX



## IEA Solar Heating and Cooling Programme

The *International Energy Agency* (IEA) is an autonomous body within the framework of the Organization for Economic Co-operation and Development (OECD) based in Paris. Established in 1974 after the first “oil shock,” the IEA is committed to carrying out a comprehensive program of energy cooperation among its members and the Commission of the European Communities.

The IEA provides a legal framework, through IEA Implementing Agreements such as the *Solar Heating and Cooling Agreement*, for international collaboration in energy technology research and development (R&D) and deployment. This IEA experience has proved that such collaboration contributes significantly to faster technological progress, while reducing costs; to eliminating technological risks and duplication of efforts; and to creating numerous other benefits, such as swifter expansion of the knowledge base and easier harmonization of standards.

The *Solar Heating and Cooling Programme* was one of the first IEA Implementing Agreements to be established. Since 1977, its members have been collaborating to advance active solar and passive solar and their application in buildings and other areas, such as agriculture and industry. Current members are:

Australia	Germany	Portugal
Austria	Finland	Singapore
Belgium	France	South Africa
Canada	Italy	Spain
China	Mexico	Sweden
Denmark	Netherlands	Switzerland
European Commission	Norway	United States

A total of 49 Tasks have been initiated, 35 of which have been completed. Each Task is managed by an Operating Agent from one of the participating countries. Overall control of the program rests with an Executive Committee comprised of one representative from each contracting party to the Implementing Agreement. In addition to the Task work, a number of special activities—Memorandum of Understanding with solar thermal trade organizations, statistics collection and analysis, conferences and workshops—have been undertaken.

Visit the Solar Heating and Cooling Programme website - [www.iea-shc.org](http://www.iea-shc.org) - to find more publications and to learn about the SHC Programme.



**Current Tasks & Working Group:**

Task 36	<i>Solar Resource Knowledge Management</i>
Task 39	<i>Polymeric Materials for Solar Thermal Applications</i>
Task 40	<i>Towards Net Zero Energy Solar Buildings</i>
Task 41	<i>Solar Energy and Architecture</i>
Task 42	<i>Compact Thermal Energy Storage</i>
Task 43	<i>Solar Rating and Certification Procedures</i>
Task 44	<i>Solar and Heat Pump Systems</i>
Task 45	<i>Large Systems: Solar Heating/Cooling Systems, Seasonal Storages, Heat Pumps</i>
Task 46	<i>Solar Resource Assessment and Forecasting</i>
Task 47	<i>Renovation of Non-Residential Buildings Towards Sustainable Standards</i>
Task 48	<i>Quality Assurance and Support Measures for Solar Cooling</i>
Task 49	<i>Solar Process Heat for Production and Advanced Applications</i>

**Completed Tasks:**

Task 1	<i>Investigation of the Performance of Solar Heating and Cooling Systems</i>
Task 2	<i>Coordination of Solar Heating and Cooling R&amp;D</i>
Task 3	<i>Performance Testing of Solar Collectors</i>
Task 4	<i>Development of an Insolation Handbook and Instrument Package</i>
Task 5	<i>Use of Existing Meteorological Information for Solar Energy Application</i>
Task 6	<i>Performance of Solar Systems Using Evacuated Collectors</i>
Task 7	<i>Central Solar Heating Plants with Seasonal Storage</i>
Task 8	<i>Passive and Hybrid Solar Low Energy Buildings</i>
Task 9	<i>Solar Radiation and Pyranometry Studies</i>
Task 10	<i>Solar Materials R&amp;D</i>
Task 11	<i>Passive and Hybrid Solar Commercial Buildings</i>
Task 12	<i>Building Energy Analysis and Design Tools for Solar Applications</i>
Task 13	<i>Advanced Solar Low Energy Buildings</i>
Task 14	<i>Advanced Active Solar Energy Systems</i>
Task 16	<i>Photovoltaics in Buildings</i>
Task 17	<i>Measuring and Modeling Spectral Radiation</i>
Task 18	<i>Advanced Glazing and Associated Materials for Solar and Building Applications</i>
Task 19	<i>Solar Air Systems</i>
Task 20	<i>Solar Energy in Building Renovation</i>
Task 21	<i>Daylight in Buildings</i>
Task 22	<i>Building Energy Analysis Tools</i>
Task 23	<i>Optimization of Solar Energy Use in Large Buildings</i>
Task 24	<i>Solar Procurement</i>
Task 25	<i>Solar Assisted Air Conditioning of Buildings</i>
Task 26	<i>Solar Combisystems</i>
Task 27	<i>Performance of Solar Facade Components</i>
Task 28	<i>Solar Sustainable Housing</i>
Task 29	<i>Solar Crop Drying</i>
Task 31	<i>Daylighting Buildings in the 21<sup>st</sup> Century</i>
Task 32	<i>Advanced Storage Concepts for Solar and Low Energy Buildings</i>
Task 33	<i>Solar Heat for Industrial Processes</i>
Task 34	<i>Testing and Validation of Building Energy Simulation Tools</i>
Task 35	<i>PV/Thermal Solar Systems</i>
Task 37	<i>Advanced Housing Renovation with Solar &amp; Conservation</i>
Task 38	<i>Solar Thermal Cooling and Air Conditioning</i>

**Completed Working Groups:**

*CSHPSS; ISOLDE; Materials in Solar Thermal Collectors; Evaluation of Task 13 Houses; Daylight Research*





