Solar Renovation Concepts and Systems

**A Report of Task 20 Subtask F
Improvement of Solar Renovation Concepts and Systems
November 1999**

Solar Renovation Concepts and Systems

IEA Solar Heating and Cooling Programme Task 20
"Solar Energy in Building Renovation"
Subtask F: "Improvement of Solar Renovation Concepts and Systems"

Technical Report Task 20 STF N12

Edited by
Andreas Haller
Ernst Schweizer AG, Metallbau

November 1999

Abstract

Under the framework of the IEA Solar Heating and Cooling Programme, a Task regarding building renovation was initiated in 1993: "Task 20: Solar Energy in Building Renovation." Within Task 20, Subtask F, "Improvements of Solar Renovation Concepts and Systems," designed and evaluated different solar renovation concepts and systems.

The objective of Subtask F was to document development activities and design strategies with a focus to improve the cost-performance ratio of solar renovation measures.

This report discusses strategies for cost reduction of solar renovation concepts and systems and documents 13 development projects. It contains designs for specific renovation projects, including general concept studies based on housing projects, product developments and research projects. Most of the projects are related to glazed balconies, solar wall heating with transparent insulation, solar thermal collectors, and preheating ventilation air.

Acknowledgement

The Swiss Federal Office of Energy financed the editing and publication of this report and the Swiss contributions, under the contract no. 50'999.

The following persons contributed to the research and writing of the report: Arne Elmroth (S), Elisabeth Kjellsson (S), Hans-Jorg Althaus (CH), Chiel Boonstra (NL), Jan-Olof Dalenback (S), Geurt Donze (NL), Karel Fort (CH), Andreas Haller (CH, editor), Sheila Hayter (US), Olaf Bruun Jorgensen (DK), Micah Sherman (USA), Henrik Sorensen (DK), Karsten Voss (D), Tom Wood (USA).

This report was printed at and is available from

Ernst Schweizer AG, Metallbau
Bahnhofplatz 11
CH-8908 Hedingen, Switzerland
Phone: +41 (0) 1-763-63-80
Fax: + 41 (0) 1-761- 88-51
E-mail: info@eschweizer.ch

at a price of CHF 50.00 excluding VAT and postage

0 November 1999 IEA (International Energy Agency) - All rights reserved.

Executive Summary

The aim of the Solar Heating and Cooling Programme's Task 20, Subtask F was to report on improved concepts and systems for ongoing renovation projects and development activities during the extension phase of Task 20. These projects should profit from the experiences of previous Task 20 work.

This technical report on Subtask F documents 13 projects in five different fields of solar renovation:

1. Glazed balconies
2. Solar wall heating with transparent insulation
3. Preheating of air for mechanical ventilation systems
4. Solar thermal collectors
5. Improved use of daylight

The selection of the activities to improve solar renovation represents the current activities in the countries involved in Subtask F. Most studies are focused on the renovation of apartment buildings.

Reference to real world applications is maintained because most of the reported studies stem from real renovation projects. Several studies disclose construction details and are therefore easily adapted to similar situations. More general studies may serve as a starting point for future activities.

Cost was identified as a key barrier for the solar renovation concepts. Under the previous Task 20 work, a wide cost-range was reported for most of the solar concepts. Many of these evaluated solar renovation projects were not cost competitive to that of conventional renovation measures. Therefore, the main goal for Subtask F was to investigate improvements to reduce investment cost and/or increase the cost-benefit ratio.

Possible strategies to reduce costs were identified including:

- Combine solar and non-solar systems
- Allow for the large dimension tolerances of existing buildings
- Focus on simple systems/components
- Focus on standardised solutions
- Improve information dissemination and occupant/owner training
- Avoid requirement of specialised experts for installation and mounting
- Conform to working habits of the craftsmen
- Optimise cost/performance ratio at low cost
- Make other systems or components redundant avoiding added cost for replacement

A majority of the reported studies combined solar and non-solar systems as a strategy to improve the cost-benefit ratio. This strategy assumes that at least one of the two systems will be or is available at no additional cost. Significant reductions of the investment cost however require much cheaper systems and components. Such a reduction can only be achieved with new product developments. Novel, improved, or much cheaper materials are required. In short: more research for solar energy systems with a focus on cost reduction is needed.

Table of Content

Part I: Report on Subtask F	1
1 Introduction	1
2 Project Selection	2
3 The Role of Systems and Components in Task 20	3
3.1 <i>Concepts, systems and components</i>	3
3.2 <i>Cost - a key figure for solar renovation</i>	3
1.3 <i>Task 20 cost reduction strategy and focus</i>	5
1.4 <i>Strategies for improvements for Subtask F</i>	6
4 Solar Concept and System Development Activities - Summaries	7
4.1 <i>Glazed balconies</i>	7
4.2 <i>Solar wall heating with transparent insulation (TI)</i>	9
1.3 <i>Solar thermal collectors</i>	11
1.4 <i>Air collector systems</i>	11
1.5 <i>Improved use of daylight</i>	12
1.6 <i>Selected projects outside Task 20</i>	13
5 Analysis	16
5.1 <i>Renovation reasons and energy demand reduction</i>	16
5.2 <i>Development</i>	17
5.3 <i>Market aspects</i>	18
1.4 <i>Improvements and innovations</i>	20
1.5 <i>Evaluation of concepts and comparison of the related projects</i>	21
1.6 <i>Projects outside of Task 20</i>	24
6 Conclusions and recommendations	26
6.1 <i>Conclusions from the analysis of the improved concepts</i>	26
6.2 <i>Recommendations</i>	27
6.3 <i>References</i>	28
Part II: Catalogue of Concepts and Systems	29
7 Introduction	29
8 Overview of Concepts and Systems	30
8.1 <i>Project status and development information</i>	31
8.2 <i>Renovation reasons, energy savings and solar energy gains</i>	32
8.3 <i>Market aspects</i>	34
1.4 <i>Innovation and results</i>	36
9 Catalogue of Concepts and Systems	38
9.1 <i>Advanced glazed balconies (D)</i>	39
1.2 <i>Advanced glazed balcony (DK)</i>	45
1.3 <i>Advanced ventilation strategy for glazed balconies (NL)</i>	55
1.4 <i>Glazed balconies and ventilation systems (CH)</i>	65
1.5 <i>Static shading for TI wall heating systems (D)</i>	73
1.6 <i>Ventilated solar wall heating with TI (CH, D)</i>	79
1.7 <i>Low cost TI wall heating system (CH)</i>	85
1.8 <i>Elimination of thermal bridges with TI (NL)</i>	92
1.9 <i>Facade integrated collector system (D)</i>	99
1.10 <i>Solar air - double envelope (S)</i>	103
1.11 <i>Solar air system with building double envelope (CH)</i>	109
1.12 <i>Roof windows with light ducts (US)</i>	115
1.13 <i>Improved daylight for multi-storey housing (DK)</i>	121
Annex	127

Part I: Report on Subtask F

1 Introduction

Purpose of the report

The Subtask F Technical Report gives an overview of the projects with an emphasis on improved concepts and systems for solar renovation applications undertaken during the final phase of Solar Heating and Cooling (SHC) Programme Task 20.

Background

The process of building renovation presents a good opportunity to increase the future use of solar energy in existing buildings and to reduce energy demand and CO₂ emissions. However, in building renovation the main priorities are usually not solar energy gains and energy conservation. Repair of deteriorated components, preservation of market value of the building, or remodelling to adapt to changed requirements are the usual reasons of renovation projects.

This situation is unfortunate but reasonable because there is a range of aspects that must be improved for solar renovation to become a common practice in the future. The first and primary requirement is the solar concepts must be cost competitive with the conventional renovation measures.

Collaborative work

During 1996 and 1997, as many innovative solar concept studies and system developments focusing on building renovation as possible were collected from six countries. Six experts were permanently, and up to six additional co-workers were temporarily involved in Subtask F.

Audience

This report is written for persons interested in improving solar energy applications, especially for building renovation. This may include persons responsible for planning and managing R&D as well as product managers of solar systems for the building sector. It can also provide designers and planners of innovative solar systems background information to more insight into technical aspects.

Intended benefit of the report

This report highlights the role of the concepts and systems in the solar renovation process. It provides insight into the cost structure of solar renovation systems and explains a range of strategies for improvements based on the experiences of Task 20 experts. For future projects, the report may help researchers and designers to focus on key aspects that lead to successful market implementation.

Content

The Technical Report is divided in two parts. Part I documents the work of Subtask F including a review of related previous Task 20 activities, draws conclusions, and provides recommendations. Part II consists of the "Catalogue of Concepts and Systems" including the detailed description of 13 projects for improved solar renovation concepts and systems.

2 Project Selection

Selection of projects

A number of system development projects lead by industry and research institutes carried out with the involvement of Task 20 experts were selected for documentation under Subtask F. All together, Subtask F documents and summarises 13 different projects in five different fields of solar renovation:

- Glazed balconies
- Solar wall heating with transparent insulation
- Preheating air for mechanical ventilation systems
- Solar thermal collectors
- Improved use of daylight

It is obvious that this project selection is rather pragmatic. The main reasons for this approach are the limited resources of the experts and the limited number of participants. However, in order to provide a more general view, some interesting activities outside of Task 20 are briefly referenced in this report (see section 4.6).

Building application and market focus

The majority of the Subtask F activities focus on the renovation of apartment buildings constructed after the Second World War. In most of the participating countries these buildings represent a considerable potential for energy savings and have similar renovation needs.

Collaborative work within Task 20

From all the different solar renovation concepts evaluated so far within Task 20 the concept of glazed balconies and its use to preheat air proved to be a common denominator and a topic for collaborative work within Subtask F.

The interest for solar wall heating is still confined to Austria, Denmark, Germany, Norway, The Netherlands, United Kingdom and Switzerland. This led to a close collaboration between Germany and Switzerland for developing solar wall heating concepts. Solar thermal collector systems and daylighting are both important topics within the IEA SHC Programme, however, within Subtask F, it was not possible to come up with enough projects to initiate any common activities on this topic.

Collaboration with the industry

Most of the subtask F projects were conducted with considerable involvement of industry and/or architects and building owners. The materials supplier together with construction companies mainly drove component and system developments. For concept designs and concept implementations, Task 20 experts worked with architects and building owners on a consultant basis.

Subtask F work

Subtask F started in the beginning of 1997 and ended in December 1998. As the actual technical work for the projects was outside the scope of Task 20, the main activity of Subtask F was to set up a uniform documentation format for the design and development projects. The project descriptions are concatenated in Part II of this report, the "Catalogue of Concepts and Systems" section. The documentation of the concepts and systems was the responsibility of the involved experts, and other Task experts did a peer review on the concept descriptions.

3 The Role of Systems and Components in Task 20

3.1 Concepts, systems and components

The three terms "concept," "system," and "component" are used frequently in the following section. These terms are explained to avoid confusion and to highlight the important messages and lessons learned in Subtask F work:

- Concept refers to the idea of an operation or a service, for example, "solar preheating of air for a mechanical (exhaust) ventilation system." Improvements of solar concepts mainly refer to new combinations and new synergism between different systems and components of a building.
- A system is the entity of physical items that are required for a basic operation or service, such as a solar domestic hot water (DHW) system.
- A component is referred to as a part of a system, such as the flat plate collector for a solar DHW system.

Besides the basic components, a system usually requires additional parts for integration into an existing building. Such parts and components are usually non-standardised and are designed individually for each project. Because of the limited flexibility of existing buildings - compared to new building designs - these requirements are more important and more prominent for renovation situations than for new buildings.

3.2 Cost - a key figure for solar renovation

Besides the energy gains of solar systems and their potential to reduce fossil fuel consumption, the important key figure is the total cost of the system. For solar energy in building renovation this is usually the marginal cost of the solar measure and the operational cost over its lifetime.

The case studies evaluated under Subtask A, "Evaluation of Existing Building Applications," in the beginning of Task 20 [1] came up with the cost of several different solar systems implemented in renovation projects before 1993. The evaluation showed a wide variety in investment costs, energy performances, annual operational costs and simple payback times for the 13 solar renovation applications (see Figure 3-1). The reasons for this spread were:

- Differences in building standards
- Different type and size of solar measures
- Different quality levels
- Systems with high and low solar coverage

Thus, the number of examples was too small allowing concluding hard evidence concerning the typical cost of specific solar renovation concepts.

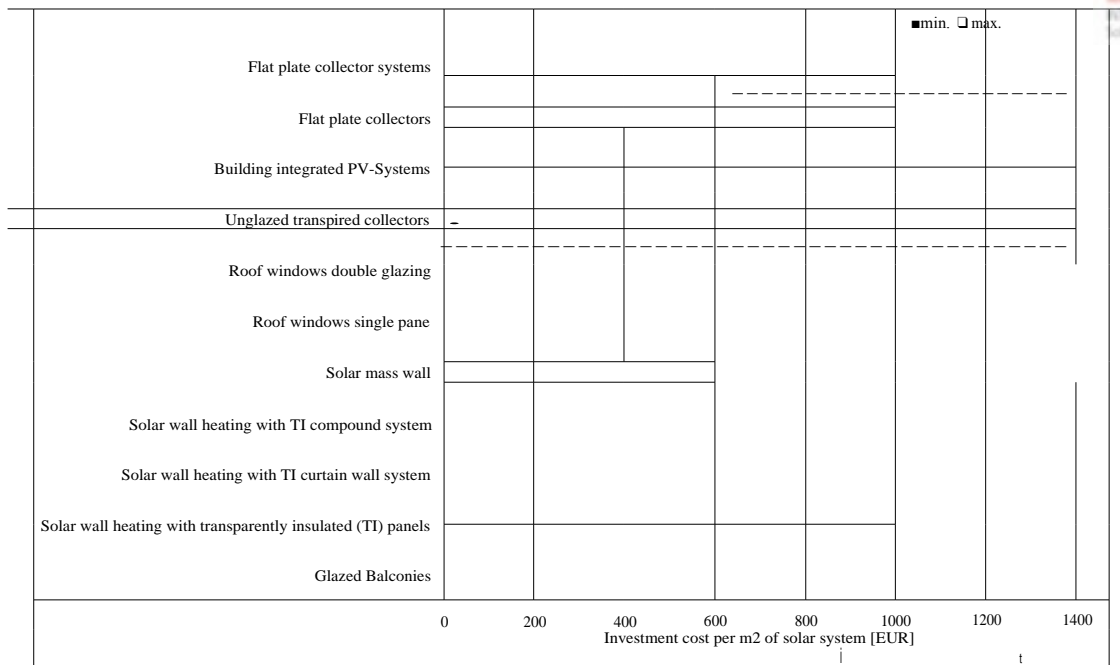

Figure 3-1: Investment cost of solar renovation concepts found under Subtask A (in C/m2 solar system)

Under Subtask B, "Improved Solar Renovation Concepts," general information about the cost of different solar concepts and systems were collected. Table 3-1 gives a summary of the findings at that stage of Task 20.

System cost	Average cost (€)	per
Component cost with added features		
Glazed balconies	250	m ³ volume
high quality folding doors	550	m ² glazing
conventional folding doors	300	m ² glazing
simple sliding doors	240	m ² glazing
Solar wall heating with transparent insulation		
• Stick system	700	m ² TI
• Sealed glazing element for stick system	200	m ² TI
• Curtain wall facade elements	420	m ² TI
and movable solar gain control	170	m ² TI
and fixed solar gain control	80	m ² TI
• Low performance system	250	m ² TI
Roof windows	90 - 350	m ² glazing
Unglazed transpired collector	40 - 160	m ² collector
Integrated PV systems	1300	peak
PV facade module	1000	m ² module
Roof system with standard modules	7 000 — 10 000	peak
Solar Collector Systems		
• Small DHW systems	1450	m ² collector
• Large DHW systems (low solar coverage)	750	m ² collector
• Small combi-systems	1800	m ² collector
Glazed flat plate collector	100 — 450	m ² collector

Table 3-1: Market price of selected solar systems and components for renovation (price level of 1996, various sources).

Table 3-1 again reflects the variations in component and system cost. Except for solar collector systems, these figures are all lower than the specific cost found in Figure 3-1. This leads to the following assumptions - some of which are common sense, but still interesting:

- Large systems are more cost effective than small ones in terms of cost per m² solar system.
- Low solar coverage leads to more cost-effective systems
- System cost reflects the fabrication cost – planing and implementation cost are not included.
- Most of the projects evaluated under Subtask A include some opportunity costs (more expensive planing, adapted components for architecturally appealing solutions) but also received open and hidden subsidies by suppliers, etc.
- The integration cost of solar DHW system is already included in today's market prices. It reflects the extended experience with this technology.

Conclusion

Even if the system and component cost are known, solar renovation cost for most solar systems may vary widely depending on various parameters and circumstances.

3.3 Task 20 cost reduction strategy and focus

The main focus of Task 20 Subtask C, "Design of Solar Renovation Projects," was on the building renovation process as a whole. The intention was to use the potential of active, passive, and hybrid solar energy systems to solve the problems of a building that lead to the need of a renovation. The experts based the rationale for this focus on several assumptions:

- In renovation projects, the equivalent energy cost of the solar system is usually calculated from the marginal cost. Conventional renovation measures for building preservation unrelated to energy demand reduction may be deducted from the total solar renovation cost.
- Using standardised solar systems and well known concepts at marginal cost will potentially lead to lower costs for solar in renovations than in new buildings.
- The complexity of adaptation and the restrictions of the existing building situation may be reduced to a minimum by evaluating and integrating solar concepts at an early stage of the renovation design.
- Additional benefits of solar systems to the energy demand reduction (e.g. comfort) can be quantified further reducing the cost for solar systems in renovation.

Lessons learned from Task 20 Subtask C and E

Again, the number of case studies within Subtask C and E of Task 20 was too limited to come up with concise conclusions regarding solar renovation systems and components. The studied and applied systems are also in very different development stages. However, we can identify some general trends from the design of the renovation projects commonly discussed in Subtask C and Subtask E work:

- Solar systems show potentially an improved cost-performance ratio when applied as integrated parts of renovations. However, compromises and limitations in renovation situations may reduce the performance and the possible use of energy gains of solar systems compared to the optimal integration in new buildings.
- Most of today's available solar systems and components were designed without detailed attention to construction and installation constraints for later building integration (exception: roof module collector, see [2]).
- Standardised systems and components are cheaper but require costly adaptations in renovation situations.
- Systems are often too complex for typical renovation situations. This leads to additional costs for planning, installation and on-site adaptation.
- High investment costs of solar systems become more prominent in the budget of a building renovation compared to the situation of new building design. Tight budgets for

renovation projects may not allow the implementation of the solar systems even if the cost/performance ratios of the solar measures are acceptable compared to the conventional measures.

Detailed information about the renovation projects can be found in [3] and [4].

Conclusions

Compared to the initial aim of Subtask C we have to admit that early consideration of solar concepts in the renovation design may be necessary, but is not sufficient or does not guarantee low (equivalent energy) cost solutions.

3.4 Strategies for improvements for Subtask F

Future advancements of solar systems and components must consider strategies for improvement. Optimisation efforts may use the (non-exhaustive) guidelines of Table 3-2.

Aim	Measure	Additional Effect
Improve cost/performance ratio	Combine solar and non-solar systems	Increases customer acceptance
Optimise for renovation situation	Various, e.g. allow adapting for the typical tolerances in dimensions	Reduces planning and installation costs
Reduce planning costs	Focus on simple systems/components	Increases acceptance of planners and designer
	Focus on typical solutions, adopt established systems to renovation situations	Improves quality, improves market acceptance
	Improve information and training	Increases acceptance and quality
Optimise for site work	Avoid requirement for specialised professionals on site	Reduces labour cost
	Conform to working habits of the site work	Reduces labour cost, improve quality, reduce failure cost
Reduce investment costs to become attractive for low budget projects	Optimise cost/performance ratio at low cost level	Increases acceptance, increases market potential
"Tunnelling the cost barrier"	Make other systems or parts of it redundant thus avoiding cost for replacement	Reduced maintenance cost for redundant parts

Table 3-2: Component and system design strategies for improved solar renovation.

4 Solar Concept and System Development Activities - Summaries

All of the projects reported under Subtask F have adapted one or more of the strategies listed in Table 3-2. The following sections give an overview of the projects that are documented in more detail in Part II "Catalogue of Concepts and Systems".

4.1 Glazed balconies

4.1.1 Advanced glazed balconies (D)

Concept: Based on a renovation project for a 14-storey apartment building in Freiburg, Fraunhofer ISE investigated the glazed balconies and the combination of glazed balconies with an exhaust air ventilation system. One focus of this investigation was to find the optimal glazing system for the balcony concerning energy savings, daylight, user comfort, and noise. The second focus was to potentially reduce the energy demand by combining the glazed balcony with the central exhaust air system. For the glazed balcony, a relatively low air change rate of 0.6 to 1.0 per hour during the heating season was assumed. Simulations showed that the heat loss from the room adjacent to the balcony could be reduced with the optimal balcony glazing by 30% compared to a conventional renovation (wall insulation). Simulations of coupling the balcony to the exhaust air system showed somewhat mixed results. The heat energy demand of the apartment can be reduced significantly, but this reduces also the mean air temperature in the glazed space. For technical evaluation and user acceptance tests, several different glazing systems have been set up at the site.



Apartment building in Freiburg, D, before renovation

Results: The project will be realised at cost comparable to conventional renovation projects in the vicinity. The cost for the balconies is compensated by keeping the facade part between the glazed balcony and apartment as they are. For tenants, a glazed balcony is more valuable as a buffer space than as an improved insulation standard.

Project status: The renovation of this building is planned to conclude in the first quarter of 1999. Several similar buildings in the vicinity may be renovated in the same way in the near future due to a municipal area development plan.

Reference: Part II "Catalogue of Systems and Concepts" - Concept no. 1

4.1.2 Advanced glazed balconies (DK)

Concept: In the case of total refurbishment of apartment buildings, it is worth the effort to renovate and glaze existing aligned balconies for use as additional heated living space. This requires super insulating windows and insulated parapets. The situation is different for external balconies: It is usually not possible to turn this type of balcony in a heated space without increased energy losses.

The renovated building with glazed balconies (left)



balconies are converted to an unheated glazed space with simple glazing constructions to reduce transmission losses. In cases of existing mechanical ventilation systems additional ventilated solar walls in the parapet can be established at almost no extra cost. In cold periods with small or no solar gains the fresh air will be preheated in the radiator integrated into the fresh air inlets. In addition, a demand controlled moisture regulated ventilation system exhausts air from the kitchen and the bathroom.

Results: The project shows the different concepts of glazed balconies. Additional simple air collectors in the parapets were evaluated on a concept level, but not modelled in details.

Project status: The renovation project is concluded. Detailed monitoring and evaluation is ongoing until spring 2000. Furthermore, the project has received an award in an architecture competition with focus on building integrated solar design.

Reference: Part II "Catalogue of Concepts and Systems" - Concept no. 2

4.1.3 Advanced ventilation strategy for glazed balconies (NL)

Concept: Dutch building codes require minimum ventilation rates per apartment. For small apartments, this leads to relatively high air change rates. In order to reduce the transmission losses, the concept of glazed balcony profits from its integration in the ventilation concept for preheating the fresh air. The exhaust ventilation in bathroom, toilet, and kitchen create an under-pressure in the apartment and the glazed balcony. Wind-pressure-independent vents then control the air inflow. By using this principle it is possible that 50 - 75% of the fresh air enters through the balcony.

Results: A glazed balcony can reduced transmission losses of the apartment by up to 20 kWh per m² heated floor area and heating season. Preheating of ventilation air in glazed balconies increases savings by an additional 10 kWh per m² of an average apartment of 70 m² heated floor area.

Project status: Conceptual design for the ventilation strategy is concluded, prototypes of the involved air vents were evaluated.

Reference: Part II "Catalogue of Concepts and Systems" - Concept no. 3

4.1.4 Glazed balconies and mechanical ventilation systems (CH)

Concept: A glazed balcony may be combined in various ways with different ventilation strategies of a building or an apartment. Several combinations with different HV systems were investigated in a study based on two real renovation projects. These combinations included a simple exhaust system, ventilation system with heat recovery, and domestic hot water production using the exhaust air as a source for a heat pump. Based on the real apartment building's possible installation, solutions to place vent and air ducts were also investigated and the cost for the different systems evaluated. Besides the criteria energy gain and cost, the influence of the different concepts on the comfort situation were of main interest.

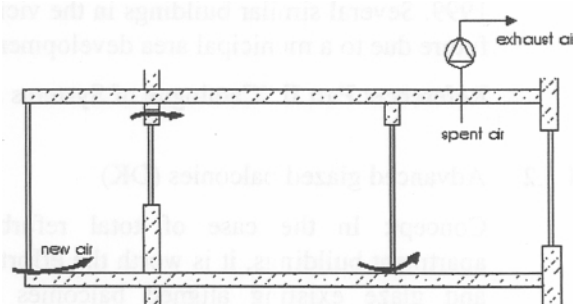

The graph shows one of the investigated concepts to combine glazed balconies and ventilation systems.

Results: From the energy conservation point of view there is an improvement with increased system complexity. However, the investment cost also increase in large steps. From an economical point of view the best choice depends on the already existing and still functional infrastructure of the building. For the more complex combinations with heat recovery in the air system, solar gains in the balcony and heat recovery efficiency start to fight each other above a certain temperature level.

In all variations preheated air from the balcony serves about 50% of the fresh air resulting in a balcony air change rate between 0.6 to 1.2 per hour during the heating season.

Project status: Concept study is concluded. One of the evaluated versions is installed in a renovation project. Evaluation of the comfort situation in the balcony is in planning but results were not available by the end of Task 20.

Reference: Part II "Catalogue of Concepts and Systems" - Concept no. 4

4.2 Solar wall heating with transparent insulation (TI)

4.2.1 Static shading system for TI wall heating (D)

Since 1996, a composite transparent insulation system for solar wall heating has been on the market. Up to now, this system lacks an integrated solar gain control. Limiting the application to less than 30% of the facade area prevents overheating in summer. This also limits the potential solar gains and contributions to the space heating in wintertime.

The study aims to identify the potential to extend this limit by using existing overhangs with other primary usage (like balconies). This will allow expanding the potential of solar wall heating systems without additional cost for solar gain control. The outcomes of this work are guidelines for using existing overhangs for gain control of solar wall heating systems in general. It may further lead to the design of cost effective and attractive overhangs.

Results: For the same gain load in summer, the active area of the solar wall heating with fixed overhang may be expanded to over 40% of the south oriented facade area.

Project status: Project concluded with a set of design guidelines.

Reference: Part II "Catalogue of Systems and Concepts" - Concept no. 5

4.2.2 Ventilated solar wall heating with TI (CH, D)

Gain control of high performance solar wall heating systems by variable shading devices contribute up to a third of the total investment cost of this solar system. It is also responsible for a major share of the operational cost. In this project the concept of solar gain control by ventilation is combined with transparently insulated facade elements that are industrially fabricated and available on the market. The focus of this research and development activity is on the optimal use of the physical properties of different absorber materials, the technical solutions for the air openings, and the cost-effective integration of the concept into the

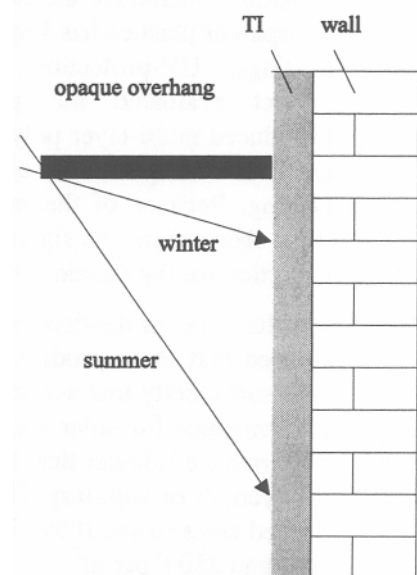

Concept of static shading by existing overhangs, e.g. balconies, for seasonal gain control of solar wall heating systems.

existing product. Within the time frame of Task 20 only the modelling and measurement of the physical properties was possible.

Results: Natural ventilation is an effective way to control gains of solar wall heating system. Some key design rules must be followed. The crucial parts are good insulated and airtight covers for the ventilation openings at sufficiently low cost.

Project status: The research project is planned to conclude with the design of a preliminary product for a demonstration project in the third quarter of 1999.

Reference: Part II "Catalogue of Systems and Concepts" - Concept no. 6

4.2.3 Low cost TI wall heating system (CH, D)

Concept: Early experiments with transparent foils and sheets as transparent insulation for solar wall heating system showed a too low energy transmittance at feasible insulation levels for central and northern European climates. In the meantime materials technology in the area of transparent plastics has improved with anti-reflex coatings, UV-protection coatings, etc. This project evaluated the potential of recently introduced multi-layer polycarbonate sheets to be used as transparent insulation for solar wall heating. Because of the mechanical structure of these sheets there is a significant potential for cost reduction for the facade system.

Results: The evaluation of the building physics showed that these products might be used as TI with sufficiently low u-value and sufficiently high transmittance for solar wall heating. The overall performance is lower than for glazed systems with honeycomb or capillary TI materials. Applied in limited areas to avoid overheating in summer, the specific cost including installation may be less than 250 €/per m².

Project status: Industry project, further activities may not be disclosed.

Reference: Part II "Catalogue of Concepts and Systems" - Concept no.7

4.2.4 Elimination of thermal bridges with TI (NL)

Concept: The end planes of concrete floors of typical housing construction in the Netherlands are not insulated. Compared to the usual cavity walls, these end planes act as severe thermal bridges. Even with an additional external layer of insulation, this construction detail remains a weak spot. The study investigates the prospects of using a transparent instead of an opaque insulation for these horizontal parts of the facade. A suitable facade insulation system is already on the market.

Results: Evaluation of the thermal impact of a transparent insulated floor slab in combination

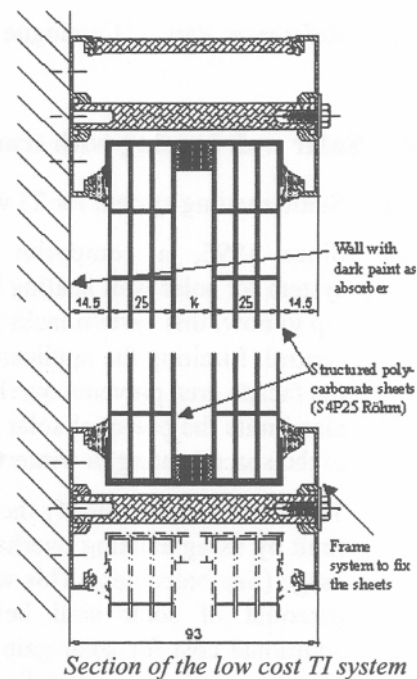

Cross section detail south facade

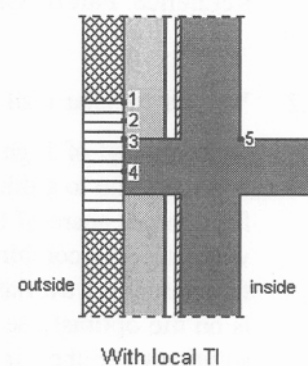

with conventional wall insulation system shows a favourable reduction of the thermal losses. The temperature distribution in the floor slab and the cavity wall is expected to be more uniform than with conventional opaque insulation for most of the time.

Project status: The theoretical investigations are concluded. A demonstration project is still missing.

Reference: Part II "Catalogue of Concepts and Systems" - Concept no. 8

4.3 Solar thermal collectors

4.3.1 Facade integrated collector system (D)

Concept: The concept is based on the combination of conventional wall insulation with a low temperature thermal solar collector for DHW. The technical solution proposes to integrate a plastic piping system in the outer plaster layer of the insulation and finishing system. The dark coloured plaster acts as an unglazed thermal collector and the piping system is separated from the wall by the insulation layer.

Results: This system is best suited for residential buildings on south west to west oriented walls and connected to a central DHW system for preheating. A solar fraction of 25% for the annual DHW demand is realistic. The economic evaluation shows that the upper cost limit for the facade integrated solar collector may be around €50 per m².

Project status: The performance of a prototype system was measured during 1999.

Reference: Part II "Catalogue of Systems and Concepts" - Concept no. 9

4.4 Air collector systems

4.4.1 Solar air systems with building double envelope (CH)

Concept: Collector-warmed air is circulated through the cavity of a second opaque building envelope. By this measure, heat losses may be reduced to very low levels. The system works with very high efficiency due to the low return air temperature. In summer, the hot air may be used for preheating domestic hot water in an air-to-water heat exchanger.

Results: The ideal second skin construction is constructed of a 50 to 60 mm cavity covered with 100 mm thick insulation. The optimal ratio is 5 to 1. For this case, solar gains of about 100 kWh per m² air collector per heating season in the Swiss midland are possible.

Project status: The project resulted in a set of guidelines. The renovation project was not realised because of cost reasons.

Reference: Part II "Catalogue of Concepts and Systems" - Concept no.10

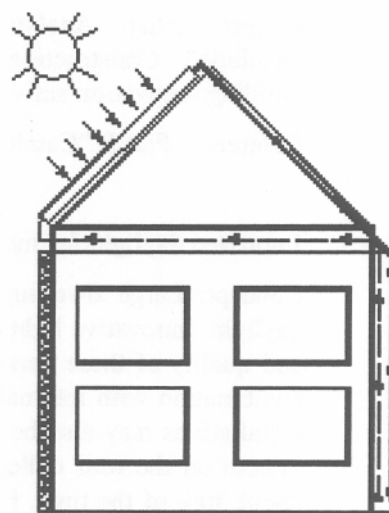

Sketch of the building with direction of the airflow

4.4.2 Solar air systems and double envelope (S)

Concept: The basic concept is identical to the previous concept. In order to reduce complexity and cost, the air-water heat exchanger for preheating domestic hot water is not

included. This study focuses on the optimal airflow and the air distribution in the additional cavity wall. For the designs, a set of rule of thumbs that resulted from IEA SHC Programme Task 19, "Solar air systems," were used.

Results: The detailed construction plans for the renovation of an apartment block were created and accepted by conventional contractors to offer tenders on a regular basis within reasonable cost limits. This is a very promising step to bring the concept to the market.

Project status: The contractors issued tenders in spring 1999. Renovation work: summer/fall 1999. Evaluation: heating season 1999/2000.

Reference: Part II "Catalogue of Concepts and Systems" – Concept no. 11

4.5 Improved use of daylight

4.5.1 Roof windows with light duct (US)

Concept: The concept is based on the combination of advanced roof windows and automated lighting systems control. This combination of systems and components provides the opportunity to decrease energy consumption of building lighting systems and increase occupant comfort. The specific components are solar tracked roof windows with appropriate glazing materials and daylight distributing systems to help collect, transport, and distribute the light.

Results: In the case of the US NREL Visitor's Centre, lighting electrical loads are expected to be reduced by more than 20% to 30%, depending on the location of the light ducts. This can only be achieved with extended control systems.

Project status: Analytical evaluation has been concluded. Construction was delayed until other building renovation activities are initiated.

Reference: Part II "Catalogue of Concepts and Systems" - Concept no.12

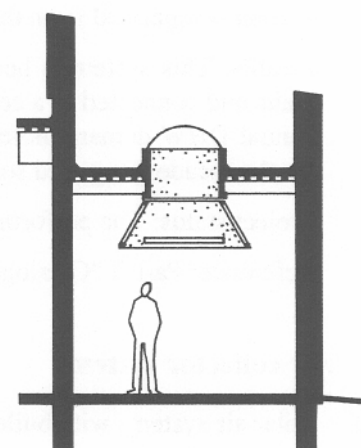

Gallery Skylight

4.5.2 Improved daylight for multi-storey housing (DK)

Concept: Large dwellings in inner cities very often have core areas without access to daylight. Innovative light collecting and light guiding equipment can improve the appearance and quality of these parts of the building. The installation of these systems is proposed in combination with internal refurbishment. New or additional channels for sanitary or power installations may also be used as light paths from the roof to the building core. A Heliostat system on the roof collects the direct sunlight. Direct (beam) sunlight is available during about 50% of the time. For the rest of the time, these systems can not provide a reasonable amount of light and need artificial backups.

Results: A model of a renovation project in Copenhagen was set up and evaluated. The measurements of light densities and distribution qualities show that minimum required levels can be achieved.

Project status: The evaluation of the concept is concluded. The refurbishment of the housing block including the installation of the light collecting and guiding systems was finalised in summer 1999.

Reference: Part II "Catalogue of Concepts and Systems" – Concept no. 13

4.6 Selected projects outside Task 20

4.6.1 Thermotropic shading for gain control of solar wall heating with TI

Above a certain temperature, thermotropic layers switch from a transparent state to a milky, light scattering state. This transformation is reversible. There is a potential to use such materials as solar gain control for solar wall heating systems with TI. Integrated in front of the transparent insulation, the thermotropic layer may switch as a function of the ambient temperature thus reducing the solar gain in summer to avoid overheating. One of the most important aspects of this self-controlled system is a sufficiently long lifetime of the thermotropic characteristic.

Results: Thermotropic materials with a switching temperature of 27°C are currently evaluated. The switching capability ranges from 85% transmission in the clear state to 35% in the diffuse, light scattering state. No results about the ageing tests have been disclosed.

Ref.: Dr. Werner Platzer, Fraunhofer Institute for Solar Energy Systems, D-79100 Freiburg, e-mail: platzer@fhg.ise.de.

4.6.2 Transpired air collector for preheating ventilation air

Building regulations in Canada require a certain amount of overpressure in the stairways of high rise apartment buildings. This is provided by central ventilation systems on the top of the buildings. It usually requires a large amount of preheated air to maintain the overpressure by the ventilation system and therefore a lot of heat energy.

When the brick facade of these buildings need be to renovated, transpired air collectors instead of the usual metal cladding might cover closed areas to the full height. The transpired air collector is directly connected to the ventilation system on the top of the building thus providing preheated fresh air at no extra energy expenses.

An example is the Windsor Housing Authority (Windsor, Ontario, CAN), the world's tallest solar collector according to the contractor company.

Ref.: Conserval Engineering Inc., Downsideview, Ontario, Canada.
Internet: <http://www.solarwall.com>.

4.6.3 Low-cost air collector system for space heating and DHW

In this concept the conventional building envelope covered by tempered single glazing forms the solar air collectors. South oriented roof and wall areas can be used. No special materials, such as selective absorbers, are used to enhance the solar absorbance thus reducing cost and enhancing the architectural appearance. Driven by a central ventilator the air circulates in the cavities between walls and roof and the glazing. A conventional air to water exchanger preheats domestic hot water. Selected hollow structures for floors and walls form heat storage and heat radiators for space heating. In summertime these radiators are bypassed.

The concept has been implemented during a renovation of a small single-family house near Lucerne, Switzerland. The building is of wood construction and was erected in 1945/46. A total renovation including new bathrooms and a new heating system was needed. Air collectors that are 45 m² are formed by the south oriented roof and a part of the south facade and produce 7 000 kWh of useful heat energy. The old and insufficient wood floors were replaced by a hollow structure covered with a layer of concrete to form the storage and low-temperature radiator. The renovated building has a low total energy demand of less than 45 kWh per m² per year. A single wood stove provides auxiliary space heating. An electric heater backs up the solar domestic hot water system. The solar systems were implemented at

marginal cost of less than 5% of the total renovation cost. The renovation project received the Swiss Solar Award 1998.

Ref.: Andreas Gütermann, AMENA AG, Steinberggasse 2, CH-8402 Winterthur; fax. +41 (0)52 214 14 44, e-mail: amena.ag@energienetz.ch.

4.6.4 Solar recladding of housing blocks – the Glasgow example

Since 1992 researchers at the Mackintosh School of Architecture, Glasgow and the Napier University, Edinburgh, both Scotland, have evaluated a range of different solar systems suited for housing renovation:

- Slated roofs as solar air collector
- Transpired plate solar collectors for preheating ventilation air
- Sunspaces for preheating ventilation air
- Timber window with integrated air collector

Together with other measures to improve energy efficiency and to solve comfort problems these systems were proposed in a multi-stage renovation package for multi-storey apartment buildings.

The combined solar-insulative cladding is estimated to reduce the annual space heating load and water heating significantly to less than 50% of the original demand. To overcome some of the constraints of investment costs the authors propose a phasing, hence spreading costs over a fairly long period.

Ref.: C.D.A. Porteous, Mackintosh University of Architecture, Glasgow School of Art, Glasgow, Scotland, e-mail: c.porteous@gsa.ac.uk.

4.6.5 Hybrid PV / Thermal concepts

Decentralised ventilation systems using new and reliable DC-motors make it possible to be driven directly by photovoltaic modules.

About 3 m² of amorphous PV modules per dwelling cover 33% - 50% of the electrical energy for such a ventilation system by solar energy. In a retrofit activity these modules can be integrated into the facade. The PV-modules may also be utilised at the same time for preheating ventilation air. Examples showing that extra cost for PV modules at current price levels reach 250 €/per m² facade. As the cost for PV-modules is expected drop by 50% within the next 5 years, simple payback times of 6 -7 years may be achieved.

Ref.: Lisbet Michaelsen, "PV-VENT: Low-cost energy efficient PV-ventilation in retrofit housing", Proceedings of the 2nd World Conference on PV-SEC, 1998.

The renewal of a (south oriented) roof creates an ideal opportunity for solar renovation for solar electric and thermal cogeneration. With the appropriate mounting systems solar electric modules can replace the traditional roofing materials. In the air channel between the new roof membrane and the substructure warm air is created and can be collected by natural or forced convection at the ridge. Several demonstration projects exist and are evaluated.

Typically the thermal power of such a roof is about two to three times higher than the electrical power. This thermal energy can be used to preheat DHW in an air-to-water heat exchanger, to preheat ventilation air, or directly for air heating systems.

Ref.: Mario Posnansky, "The importance of hybrid PV-building integration" for PV-HYBRID-PAS seminar 1997, Brussels. Contact: Atlantis Energy Ltd., CH-3012 Bern, phone: +41 31 300 32 20, fax.:+41 31 300 32 30.

An additional example is the Task 20 solar renovation demonstration project "The Yellow House". See [3] and [4].

4.6.6 Flexible facade system (DK)

Solar systems usually cover only a part of a building facade. Especially in inner city areas solar applications may only be applicable in the upper levels. To keep the additional costs for such solar facade parts in a whole facade renewal as low as possible a flexible facade system has been developed. The system allows construction of extensions and buffer spaces and to add solar components for low or moderate additional cost. The facade system is intended to dramatically reduce design and construction time. The construction of joints, air inlets, feed through for pipes and cables are solved in a standardised way. The flexible facade system is designed to comply with the architectural requirements for inner city renewal. A demonstration project is carried out in 2000.

References:

- "Urban Ecology Working Conference – Catalogue on ecological systems". SBS Urban Renewal, Copenhagen, Denmark, 1997
- Flexible Facades, Urban renewal project, Copenhagen, DK
- Osterbo, Vejle, DK (EU DGXVII THERMIE project FLEXREN).

Contact: Olaf Bruun Jorgensen, Esbensen Consulting Engineers, Tel: +45 33 26 73 00, fax: +45 33 26 73 01, e-mail: o.b.joergensen@esbensen.dk

5 Analysis

5.1 Renovation reasons and energy demand reduction

Renovation reasons

The renovation reason is the starting point for all projects in Task 20. It is also the starting point for the review of the Subtask F projects.

The analysis of the project reports (see Part II) shows that facade renewal is the common denominator for most of the improved solar renovation concepts documented. This includes the cure of structural problems, thermal improvements and upgrading of the appearance.

Besides facade renewal, thermal comfort issues per se are a very prominent reason for renovation (mould, moisture, draught). They are to a large extent related to excessive energy losses. They can be solved by improving the thermal characteristics of the building envelope and by improving control of the air change rate.

Focus of the solar concepts

The focus of most of the improved solar renovation concepts is on the thermal aspect. The other needs for facade renovation, like the cure of structural problems, comfort, etc. come as a secondary benefits.

In summary, Subtask F concepts cover the following renovation needs:

- Renewal of the facade (structural maintenance, thermal improvement, upgrade appearance)
- Extension of the living space (seasonal or all year)
- Shield from (traffic) noise
- Added value for the occupants
- Improvement of air quality
- Renewal of the domestic hot water (DHW) system
- Improve visual and thermal comfort
- Re-roofing
- Reduction of heat energy demand

Energy savings and solar energy gains

Several projects reported under Subtask F confirmed the results of Subtask B regarding energy savings and solar energy gains. However, compared to Subtask B most projects documented in this report are much more detailed, based on real renovation situations and evaluated for different climatic situations. Table 5-1 summarises energy savings and solar energy gains. Energy savings are defined as reduction in transmission losses due to the lower U-value of the renovated building or building part because of the application of the solar system. The solar energy gains are evaluated as the energy demand reduction by the effects of the solar radiation.

These energy figures were not available for all concepts and projects at the time of reporting. Some projects did not evaluate the solar gains specifically.

Glazed balconies and mechanical ventilation systems: The useful solar gains of the glazed balcony can be improved when designed in combination with mechanical ventilation systems. Within a certain range the improved solar gains are almost independent of the air change rate in the balcony.

Solar renovation concepts	Energy savings	Solar energy gains
Glazed balcony and mechanical ventilation	10 — 20 kWh/m ² *	5 — 10 kWh/m ² *
Solar wall heating with Transparent Insulation	25 — 60 kWh/m ² **	20 — 100 kWh/m ² **
Solar thermal collector (facade)	Not applicable	Figures not available
Double envelope with air collector	10 — 20 kWh/m ² *	
Daylight	Not applicable	Not evaluated

* Per m² of heated floor area

** Per m² of collector area

*** In combination with advanced light control

Table 5-1: Typical energy savings and solar energy gains of the solar renovation concepts evaluated under Subtask F. For the concept of the double envelope with air collector, energy savings and solar energy gains can not be differentiated.

- Solar wall heating with TI: All improved solar wall heating systems with TI report to be able to compensate the transmission losses. The amount of energy savings depends on the level of transmission losses before the renovation. The solar gains depend strongly on the performance of the TI system.
- Solar thermal collector: Basic component evaluation showed that the efficiency of the unglazed facade collector is about 25% lower than for a state-of-the-art flat plate collector. Further, the lower insulation level leads to an increased heat loss factor and problems with uniform flow distribution need to be solved as well. These factors make this collector design more vulnerable to radiation levels and operating temperatures. Solar energy yields may be best on south-west facades and for preheating applications. The approved characteristics of the collector were not available at the time of reporting.
- Double envelope with air collector: The solar collectors gain up to 100 kWh per m² collector are and heating season. The double envelope can reduce the transmission losses by 10 to 20 kWh per m² of heated floor area and heating season.
- Daylighting: Very impressive is the relative energy demand reduction for lighting in the renovation project of the NREL Visitor's Centre. Constructed in 1993, the building was not equipped with the latest energy savings technology from the beginning. The measures - except for the light ducts - may also be rather unspectacular and implemented with off-the-shelf technology. However, this project shows the huge unexploited potential for improvements in this field in the USA.

5.2 Development

Development status

The development status of the various projects includes the whole range from qualified renovation design to demonstration project, and from evaluated prototype to new product development. It reflects on one hand that we have two different types of projects (renovation projects and R&D projects) and on the other hand that schedules of the different projects are unrelated.

Industrial involvement

It was an important aim of Subtask F to reach a high level of involvement of the related construction industry. In Table 5-2 the consultants (architects, energy and HVAC consultants) are not specifically listed. These experts were involved in most projects. The involvement of the industry ranges from the usual product information and design support to joint product development. In 6 projects, manufacturers were designing prototypes for evaluation and demonstration. Four projects lead or are planned to lead to new products from the building industry.

Concept group and project number	Type of industry involvement				
	Product information and support	Regular contracting / supplier	Prototype design	Demonstration project	Product or system development
Glazed balcony and mechanical ventilation	1				
	2				
	3				
	4				
Solar wall heating with Transparent Insulation	5				
	6				
	7				
	8				
Solar thermal collector (facade)	9				
Solar air collector systems	10				
	11				
Daylight	12				
	13				

Table 5-2: Industry involvement in the projects reported under Subtask F (horizontal hatching: involve-ment up to reporting date; vertical hatching: planned follow up activity)

Design tools

In most of the projects sophisticated design tools have been used:

- Multi-zone building simulation tools
 - Ashling 5.1
 - CAPSOL
 - DOE2.1E
 - TRNSYS 14.2
 - Tsbj 3
- Solar air systems / ventilation systems
 - MVRM 5.0 (multi- zone ventilation)
 - TransAir (simulation of air collector systems based on TRNSYS)
- Two-dimensional heat transfer
 - THERM
 - SECTRA
- Daylight
 - Adeline / Radiance
 - DAYLIGHT
 - Lumen Micro 7.5

Especially the evaluation of the combination of glazed balconies and mechanical ventilation systems showed the lack of suitable and easy to use (integrated) design tools. An evaluation of glazed spaces requires multi-zone models with correct distribution of solar gains and heat transfer by air. Furthermore, the impact on the daylight properties needs also to be considered and requires today a different set of tools.

5.3 Market aspects

A more intense collaboration with industry requires researchers to have an idea about the practical relevance of the R&D and demonstration projects. For some of the projects, the information is based on the results evaluated during Subtask B (for example glazed balconies, double envelope with air collector). For some concepts, new market evaluations have been made (for example "low-cost" solar wall heating). However, it must be mentioned

that the information about market aspects is generally of lower quality than the technical information in this Technical Report.

Building types

Solar energy renovation applications to support space heating and domestic hot water heating is primarily suited for residential buildings. Table 5-3 shows that the projects focus on apartment buildings. The reports show that some of the heating applications may also be well suited for other residential buildings such as detached or row single family houses, industrial halls, and public service buildings.

The potential for improved use of daylight is mainly in the area of commercial and industrial buildings. The concept of light guiding to illuminate building cores may improve all type of buildings with large depth and is not restricted to a certain utilisation of the building.

Solar renovation concepts	Apartment building	Commercial & office building	Single family home	Industrial building	Public Service buildings
Glazed balcony and mechanical ventilation					
Solar wall heating with Transparent Insulation					
Solar thermal collector (facade)					
Solar air collector systems					
Daylight					

Table 5-3: Application focus on building type (horizontal hatching: main focus; vertical hatching: possible applications)

Additional benefits

In the project reports found in Part II additional benefits of the improved concepts are listed with respect to the main goal(s). It must be noted that the additional benefits of one project may be the primary goal of the other, and vice versa (see section 5.1).

Application potential

Experts working on the projects were asked to come up with ideas about the application potential for their concepts. The results of this investigation are rough estimates and usually reflect the technical potential. The figures are also related to the respective national markets where the project was conducted. The real markets in the different countries are strongly dependent on the cost of the solar systems and are even more difficult to evaluate.

Cost target

Compared to the studies in Subtask B, "Improved Solar Concepts," cost is a much more important topic for the projects documented under Subtask F. Most of the projects have a very clear cost target as a goal of the improved concept. Table 5-4 gives an overview of these aims. It is important to highlight that for some of the projects it is not appropriate to give absolute costs but rather refer to marginal costs compared to conventional renovation measures. Some figures refer to a specific renovation project and may not be valid for another renovation situation.

Solar renovation concepts	Cost targets (may be different within the same concept depending on the system's performance)	Estimated for country
Glazed balcony and mechanical ventilation	€ 6000 – 7000 per glazed balcony, plus € 700 – 1000 for coupling glazed space to the mechanical ventilation system Additional € 300 - € 600 per m ² of glazed area	D/CH/DK CH NL
Solar wall heating with transparent insulation	No additional cost for use of static shading Cheaper than conventional movable blinds < € 280 per m ² of "low cost" solar wall heating system < € 140 per m ² for elimination of thermal bridge	All CH CH/D NL
Solar thermal collector (facade)	< € 50 per m ² of "low cost" facade collector (marginal cost)	D
Solar air collector systems	< € 20 per m ² double envelope facade < € 100 per m ² air collector	S
Daylight	No representative figures available	US/DK

Table 5-4: Cost target of the improved solar renovation concepts of Subtask F

5.4 Improvements and innovations

Innovative character of the projects

The aim of Task 20 was to investigate the use of solar energy for building renovation with the solar systems and components available on the market. Research on materials and the development of novel concepts and systems was not meant to be within the scope of this Task. Thus, most of the projects documented under Subtask F have used strategies for improvements within the set scope.

However, the analysis of the projects designed under Subtask C and reported under Subtask E shows that within this scope, only limited improvements of the cost-benefit ratio of the solar energy gains and energy savings for renovation applications are possible. Because of these experiences, there are also a few studies included in Subtask F dealing with research and product development (concepts 6, 7 and 9). This approach has the potential to explore novel solutions using less and/or cheaper materials or addressing completely different needs.

Applied strategies

The experiences from the previous activities of Task 20 led to the proposal of strategies for improvements for solar renovation concepts and systems (see section 3.4). Table 5-5 shows the improvement strategies applied for the projects reported under Subtask F.

- Most of the reported projects focus on cost-benefit optimisation by combining solar and conventional systems. This is a successful strategy if at least one of the systems is required and funded for other reasons than solar energy gains.
- Two projects focus explicitly on renovation by either taking advantage of the existing building structure or propose new solutions to solve problems of wide spread construction detail of existing buildings (no. 5 and no. 8).
- Two projects try to overcome the high investment costs of solar systems to increase the market for the solar concept. However, this strategy does not automatically improve the cost-benefit ratio (no. 7 and no. 9).
- One project succeeded in meeting the cost targets by compensating some of the investment cost and making the conventional renovation obsolete (no. 1).

Concept group and project number	Improvement strategy					
	Improve cost/performance ratio (system combination)	Optimise for renovation	Reduce planning cost	Optimise for construction site	Reduce investment cost for low budget situations	Tunnelling the cost barrier
Glazed balcony and mechanical ventilation	1					
	2					
	3					
	4					
Solar wall heating with transparent insulation	5					
	6					
	7					
	8					
Solar thermal collector (facade)	9					
Solar air collector systems	10					
	11					
Daylight	12					
	13					

Table 5-5: Strategies applied in the documented projects of Subtask F (horizontal hatching: main strategy; vertical hatching: secondary strategy)

5.5 Evaluation of concepts and comparison of the related projects

5.5.1 Glazed balconies and mechanical ventilation systems

Four projects are documented using this concept. However, they represent three distinct ideas, though they use basically the same concept.

Two projects (concept no. 1 and no. 4) start with the glazing as a measure to solve thermal bridges of the existing balcony structure in the realm of a facade renovation. Both projects use airtight structures with — at least — double-glazing. Relatively low basic air change rates are planned (0.6 per hour). The combination of the glazed balcony with a mechanical ventilation system to preheat the fresh air helps to make better use of the solar gains in the balcony.

The cost for the glazed balcony is not different as in previous projects reported under Task 20 (€6000 to 7000 per apartment). The additional useful energy gains will slightly improve the equivalent energy cost for the glazed balcony. The marginal cost for this measure must be covered by the added value for the apartment (increase of rent) and the building as a whole (improved occupation rate).

Both projects show that the cost for a mechanical exhaust ventilation system in addition to a glazed balcony may be covered by the additional solar energy gains. More sophisticated ventilation systems may result in equivalent energy cost comparable to that of conventional renovation measures. Concept no. 4 shows that the cost may be only twice as much as the cost for heat energy generated by fossil fuel. This does not take into account the increased comfort and air quality.

In renovation situations where a mechanical exhaust systems is already installed and a glazed balcony will be constructed for non-solar reasons, the required additional efforts to guide a significant part of the fresh air through a glazed balcony is very limited. The additional cost for the required measures will be covered by the solar gains in most of the cases.

Depending on the airflow schemes, a reduction in the mean air temperature and hence in the comfortable use of the balcony space must be taken into account.

It is worth mentioning that the concept to combine glazed balconies and mechanical ventilation systems favours – as all such concepts – the cold and sunny climate (for example, the alpine climate).

The Danish project (concept no. 2) strategy is to choose between different designs depending on the layout of the existing balcony:

- For a aligned balcony the focus is on the expansion of the living space of apartments by including existing balcony into the renovated building envelop. With low-e glazing and well-insulated parapets the overall transmission losses can be reduced and heat energy demand decreased even with the expanded heated floor area. Preheating of the apartment ventilation air is included in a simple air collector structure in the parapet. To avoid draught and cold air, the air inlet is integrated into the convector of the radiator.
- For a projecting balcony a simple glazing system is promoted for cost reasons. This space can only be used for a limited period of time and is used to preheat ventilation air during the heating season.

For both situations, a humidity controlled mechanical ventilation system (exhaust from kitchen and bath) is installed in the apartments to maintain a good indoor climate.

Dutch building code regulations require a minimum ventilation rate per apartment. In the example project this results in an air change rate of 1.5 per hour. Therefore the project focus on the preheating of the ventilation air to reduce the air change losses as much as possible (concept no. 3). The type of glazing influences the energy demand reduction. The difference between simple single glazed systems and high quality low-e glazing systems are about 10 kWh per m² heated floor area and heating period. The decision between the solutions will, in practice, probably depend on the cost and therefore on the layout of the balcony.

Concept	Type of balcony design and use	Ventilation system	Air inlet	Air change rate of the apartment	Air intake through balcony
German concept	Well insulated solar heated glazed space	Fixed rate central exhaust ventilation	By air valves to balcony	nominal 0.6 h ⁻¹	50% of total air change volume (~ 60 m ³)
Danish concept	Well insulated heated living room	Moisture controlled ventilation	Behind radiators or integrated in convectors	0.2 – 1.2 h ⁻¹ average 0.4 h ⁻¹	75% of total air change volume
Dutch concept	Different qualities of solar heated glazed spaces	Fixed rate individual exhaust ventilation	Wind-pressure-independent vents in balcony and exterior walls	0.8 – 1.3 h ⁻¹	30% to 50% of total air change volume
Swiss concept	Well insulated solar heated glazed space	Various systems	Fix openings to balcony and air valves between balcony and apartment	nominal 0.6 h ⁻¹	50% of total air change volume (~ 60 m ³)

Table 5-6: Comparison of the different concept variants for the glazed balcony and mechanical ventilation system

5.5.2 Solar wall heating

Again there are four projects dealing with the same solar concept with very different objectives.

The goal of the German concept no. 5 is to use the existing building structure as solar gain control of the solar wall heating for no additional cost. First, this does not lower the solar

system cost. It may even rise the total solar system cost as it leads to more solar wall heating area. However, the additional solar wall heating gains may eventually allow, in specific cases, a reduction in the cost of the installation for the existing conventional heating system and compensate for (some of) the cost for the solar.

Concept no. 6 is a research and development project with the aim to use integrated natural ventilation as solar gain control. It is an attempt to create a more versatile solution to the problem of overheating in summer. The direct outcome of this project will not have much impact on the investment cost. The goal is not to increase the cost compared to a system with venetian blinds as solar gain control. The maintenance cost may be lower with this solution. The main direct impact would be a more pleasant and architectural acceptable solution. In addition, this concept has the potential to lead to more cost efficient solution when the principle of overheat control can be applied to cheaper solar wall heating systems.

Concept no. 7 is a German/Swiss feasibility project of industrial partners. This study project takes advantage of developments of materials technology. It opens the opportunity to build solar wall heating at much lower investment costs. Though solar gains are reduced, the cost performance ratio is still improved compared to the high performance glazed systems. In addition, a transparent insulation system based on multi-layer sheets is also better suited for handling in parts at the construction site. Thus, complete prefabrication is not required. For a good market acceptance, it must be well suited for combination with the conventional opaque insulation systems and suitable for mounting by the facade insulation contractors.

Concept no. 8 focuses on solving construction problems. The specific and widely used construction technique of a certain period remains a weak spot for thermal losses with conventional renovation measures. The concept to compensate thermal bridges by transparent instead of opaque insulation is a truly innovative solar renovation concept. Unfortunately, the currently available products are still too expensive by a factor of 2 for a broad market acceptance. The question remains, if the cost problem may be solved with a dedicated version of the product just for this application. There may be a certain potential just by means of the economy of volume.

5.5.3 Air collector systems and facade insulation

Both reported projects (Concepts no. 9 and 10) are based on the current state-of-the-art knowledge established under IEA SHC Programme Task 19 "Solar air heating systems". These projects are also contributions to Task 19.

However, the contents of these two studies are complementary. The Swiss project concentrated on the optimisation of the air hydraulic system. The solar renovation of the building used for the study will unfortunately not be realised. The Swedish study focused on the constructive details. The hydraulic aspects are designed by expert's knowledge without further investigations. This solar air system will be built as part of a large renewal project.

Unfortunately, none of the project cost figures were available by the time of reporting. There is no indication yet on the cost effectiveness of this concept compared to conventional facade insulation. For the Swedish project it was only known at the time of reporting, that several contractors were able to submit tenders that are within the budget limits of the renovation project.

5.5.4 Solar thermal collectors (facade)

Concept no. 9 proposes an unglazed collector integrated into the finishing layer of the facade insulation. Unglazed collectors with non-selective absorbers have some tradition, especially for swimming pool applications. Recently, unglazed collectors with highly selective surface

were successfully evaluated in roofs and facades for preheating domestic hot water. The main advantage is the lower cost of the collector field.

The evaluation results on solar energy gains by the proposed unglazed collector with non-selective surface are unfortunately not available at the reporting date. However, from the prototype evaluation, high sensitivity to wind and ambient temperatures can be expected. Therefore, the solar gains of this renovation concept will also be very dependent on the system design (mean operating temperature of the collector).

For solar renovation this is a very promising system if the target for the marginal cost of less than €50 per m² can be reached.

5.5.5 Daylight optimisation in renovation

The two documented concepts on improving daylight utilisation follow very different approaches.

Concept no 12 documents a complete renewal of the lighting concept using different measures. The goals are the reduction of the electrical energy consumption by improved control and additional use of daylight with the help of special skylights. The results in terms of reducing the consumption of electrical energy are impressive.

However, the report highlights the complexity of the task of a light remodelling of an existing building. Especially the required structural changes (roof windows) may be costly. Its impact to the thermal characteristics of a building must be carefully considered. The example shows, however, that there is a positive balance between gains and losses.

There are no economical aspects reported, but it is not expected that the reduced electricity bill will cover the required investments. On the other side, the gains in visual comfort may have much a more economical overall impact.

It shows also that with an intelligent design there are many opportunities for daylight instead of artificial light. It seems that the proposed solar concepts are best suited for large low-rise buildings as most of the measures use some type of skylights. Thus, there is a large market especially in the USA, Canada and Australia.

Concept no. 13 proposes a much more limited concept to improve the use of daylight in a renovation context. The idea of bringing light, amenity and visual comfort, into the dark central parts of a larger building is intriguing. It is also an adaptation of the Heliostat application known from public spaces (shopping malls etc.) to dwellings. The differences may come with the distribution in the dwelling. The report falls somewhat short on the analysis where and how to use this – sometimes highly – fluctuating light in a housing situation.

The proposal is also based on a highly technical installation with computer controlled sun tracking systems etc. This may be acceptable for a commercial building with professional maintenance personnel. Whether or not such aspects may reduce the market changes is unclear.

5.6 Projects outside of Task 20

Section 4.6 discusses several ideas and concepts developed outside of IEA SHC Programme Task 20 that are related to solar renovation. The concepts and projects in section 4.6 may not be exhaustive and other developments not earmarked specifically for renovation may also be applicable to existing buildings. However, it is interesting to note that – with two exceptions – all these concepts deal with solar preheating of ventilation air. Some systems use dedicated



absorbers and others use the combination of passive or active solar systems to co-generate warm air for preheating or directly for air heating.

6 Conclusions and recommendations

6.1 Conclusions from the analysis of the improved concepts

Concepts and projects

During the two years of Task 20 extension, detailed information on 14 projects for improved solar renovation concepts were collected under Subtask F. None of these projects were under direct control of the IEA SHC Programme. Task 20 was not in the position to co-ordinate the schedules of these projects. Some of the projects are still ongoing at the time of reporting. The results presented in this technical report therefore have a snap shot character.

Renovation reasons and additional benefits

Most of the investigated projects focused on the renovation of apartment buildings. And for most of the projects facade renovation is the rationale to implement the solar concept. With the combination of solar and non-solar renovation measure more of the potential additional benefits can be harvested in the same renovation project.

Energy impact

The Subtask F studies confirmed the results concerning energy demand reduction and solar energy gains from the simulation studies under Subtask B "Improved Solar Concepts".

Industrial involvement

The industrial involvement during this phase of Task 20 was significant. Four projects lead or are planned to lead to product development by the industry.

Application potential

For some of the concepts the application potential investigated under Subtask B are still valid. All proposed concepts have in common that the technical potential is very big. But the real markets of today are very small or not even developed.

Cost target

For most of the projects the experts have a clear idea of the cost target to be reached for the project. However, it is not always clear what the market impacts will be if these goals are achieved.

Design tools

For the same type of design evaluation a whole range of different tools were used during Subtask F work. Most of the projects were also required to use several tools for the same renovation concept. Subtask F showed again that building renovation with solar concepts and systems might add to the complexity of renovation projects.

Improvements and innovation

All projects reported under Subtask F made use of one or more of the improvement strategies identified in section 3.4. In general, under Subtask F various new concepts and systems are reported that may lead to promising solutions in the future. However, the potentials of these strategies have not been fully exploited in the 13 projects.

Concepts and solutions

The various projects exploring the concept of combining glazed balconies and mechanical ventilation systems show that basic concepts can lead to very different solutions and technical systems depending on the border conditions related to national codes and building practices. However, there are many common problems that need to be solved for most of the reported concepts and systems independent of national peculiarities.

The review of a set of solar renovation projects outside of IEA Task 20 shows that we did not cover the full range of concepts. Notably other types of solar air heating systems and co-generation of electricity and heat (PV / thermal) may be important additional concepts with a high application potential for solar renovation.

6.2 Recommendations

Gain more detailed market knowledge

Applied research and development activities to improve solar renovation concepts will profit very much from a better and more detailed understanding of the market needs and market barriers.

Design guidelines are required

Unlike as for most conventional building renovation practices, there are no rules available to help planners and architects to solve their problems quickly and efficiently. Especially for the combined solar and non-solar renovation concepts, good design guidelines are necessary in order to be accepted for wide application. The complex set of design tools used in the projects will not be acceptable by regular planners and architects.

More focused R&D activities

Most of the reported projects start from a specific renovation project. This guarantees a high level of practical value of the study. On the other side, this may blur the more general context of the problem and the solutions seem somewhat arbitrary.

A more detailed analysis for the various technical concepts in its renovation context may lead to new and standardised solutions. Future developments should focus on the following aspects:

- Application specific solutions: Optimisation of solar systems for specific existing construction details and renovation problems.
- Building type specific solutions: Optimisation of solar concepts for specific building types.
- Identification of best case situations for cost effective solar renovation concepts and systems. This may lead to cost effective basic solutions (technology platforms) with adaptations for the real life variants.
- Identification of cross-technology application problems or cost factors in order to concentrate on basic solutions to be used by various concepts and systems.
- There is a large potential for other solar renovation systems that have not been addressed by Task 20 and may be important in the future, such as other concepts for solar preheating of air and co-generation of electricity and thermal energy in the facade and the roof.

More demonstration projects and co-operation with the building industry

Further demonstration projects including detailed monitoring and evaluation are still required. And last but not least, there is still need for closer co-operation with the building industry.

6.3 References

- [1] Jan-Olof Dalenback, "Solar Energy in Building Renovation", article published in *Energy in Buildings*, 24, (1996), p.39 – 50, Elsevier Science.
- [2] IEA Solar Heating and Cooling Programme, Task 20 "Solar Energy in Building Renovation", *Solar Collectors, Glazed Balconies, Transparent Insulation*, James & James (Science Publishers) Inc., London, 1997.
- [3] Olaf Bruun Jorgensen, "Solar Renovation Demonstration Projects – A Technical Report of IEA Solar Heating and Cooling Programme, Task 20 Subtask C", Esbensen Consulting Engineers, Copenhagen, 1998.
- [4] Karsten Voss, "Solar Renovation Demonstration Projects: Results and Experiences", James & James (Science Publishers) Inc., London, 1999.

Part II: Catalogue of Concepts and Systems

7 Introduction

Subtask F "Improvement of Solar Renovation Concepts and Systems" of IEA SHC Programme Task 20 "Solar Energy in Building Renovation" is an extension activity to the originally planned work of the Task. The aim of this Subtask is the evaluation and documentation of ongoing national activities on solar renovation with focus to improved concepts.

These activities are usually part of national solar renovation demonstration projects, international demonstration projects or research and development projects with contributions from industry. The Catalogue of Concepts and Systems documents only projects from the participating countries. Neither the type of concepts nor the variation of systems documented is therefore exhaustive.

Some of these concepts are still under evaluation, others will be, or are already implemented. Depending on the level of industrial involvement some ideas may lead to improved products.

Content

The overview section to the catalogue provides a comparative overview of the concepts, systems and components discussed and will lead to the specific concept of interest.

The system and concept section contains 13 reports of development projects in a uniform reporting format: The reporting format is structured in three sections and contains the respective information depending of the status of the project:

- General project information including specification, development status and market potential
- Concept evaluation including modelling information, evaluation results and conclusions
- Prototype construction or full scale installation including evaluation and/or monitoring results and conclusions

Audience

The intended audiences of this catalogue are:

- Fellow researchers in and outside of the IEA Solar Heating and Cooling Programme. The concepts may indicate further potential for improvements and promising working areas.
- Government decision-makers. To be used as a guideline for further demonstration projects.
- Companies of building components. To be used as a guideline for improved or new products.
- Planners and engineers in the building construction sector. To be used as reference for novel concepts to be adapted and further improved.
- Municipalities and private building owners. To be used as an inspiration for renovation projects.

The Catalogue of Concepts is part of the technical report on IEA Task 20, Subtask F.

8 Overview of Concepts and Systems

The concepts discussed in Subtask F originate either from real renovation project or industrial development activities. They are therefore based on realistic situations or on a market oriented aims.

Table 8 - is a list of the projects and Table 8-2 gives a first overview of about the status of he projects.

Table 8-3 gives an overview of the renovation reasons and summing the potential energy savings and solar energy gains.

Table 8-4 sums up the market aspects of the components and systems: Building type, additional benefits besides solving the basic renovation problem(s) and energy demand impact.

Table 8-5 shows the innovative goals and the results of the projects.

Project No.	Name and contributor (countries in brackets)	Short description
1	Advanced glazed balconies (D)	Combination of glazed balconies and mechanical exhaust system in a 14-storey apartment building.
2	Advanced glazed balcony (DK)	Glazed balcony optimised for energy demand reduction and solar gains in a multi-storey apartment renovation project.
3	Advanced ventilation strategy for glazed balconies (NL)	Optimised combination of glazed balconies and exhaust ventilation for Dutch apartment buildings.
4	Glazed balconies and ventilation systems (CH)	Evaluation of glazed balconies and various ventilation schemes for apartment buildings based on real examples.
5	Static shading for TI wall heating systems (D)	Optimal use of existing local shading elements for the solar gain control of solar wall heating systems with TI.
6	Ventilated solar wall heating with TI (CH,D)	Evaluation of the potential of natural ventilation for solar gain control instead of blinds etc for solar wall heating systems with TI.
7	Low cost TI wall heating system (CH,D)	Evaluation of transparent multi layer sheets to be used as TI for solar wall heating systems.
8	Elimination of thermal bridges with TI (NL)	Critical thermal bridges in the facade can be eliminated effectively with transparent insulation using moderate insulation layer dimensions.
9	Facade integrated collector system (D)	Evaluation of flexible piping integrated in the plaster of a wall insulation system provides low cost collector system for water preheating.
10	Solar air – double envelope (S)	In a renovation project solar heated air is directed into the cavity between the existing facade and a new layer reducing the transmission losses of the building by solar means.
11	Solar air system with building double envelope (CH)	Evaluation of the optimal hydraulic concept for solar air heated double envelope facades.
12	Roof windows with light ducts (US)	Optimisation of the use of artificial and natural light in a large office/public building.
13	Improved daylight for multi-storey housing (DK)	Evaluation of the application of light guiding concepts known for commercial buildings to housing situations.

Table 8-1: List of Subtask F projects

8.1 Project status and development information

Concept group, project number and country of origin	Development Status	Industry involved and type of involvement	Design tools used in the project
Glazed balcony and mechanical ventilation	1 D	Demonstration construction completed Building under evaluation	Manufacturer of glazed balcony systems and ventilation systems: regular contractors TRNSYS 14.2, Radiance, THERM (2-dim. heat flow)
	2 DK	Demonstration construction completed Building under evaluation	Facade manufacturer and manufacturer of glazed balcony systems (design, development) Regular contract basis Tsbi 3C, Adeline / Radiance, DAYLIGHT
	3 NL	Conceptual design Prototype components evaluated	Manufacturers for ventilation systems: product development MVRM 5.0 (multi- zone ventilation) Tsbi 3/TRNSYS
	4 CH	Qualified concepts for all variants Demonstration project for one variant under evaluation	Manufacturers for glazed balconies and ventilation systems: regular contractors Proprietary tool based on spreadsheet technique, TRNSYS 14.2
Solar wall heating with Transparent Insulation	5 D	Qualified concept	TI system manufacturer TRNSYS 14.2
	6 CH	Qualified concept	Metal facade manufacturer: prototype and system development TRNSYS or TrnsAir type may result from the project
	7 CH D	Qualified concept Prototype evaluated	Manufacturers of facade insulation system, metal facade and structured sheet: Product development Proprietary energy balance evaluation tool from Fraunhofer-ISE
	8 NL	Qualified application concept	Manufacturer of TI system: product information CAPSOL (multi-zone heat transfer) SECTRA (2-dim. heat transfer)
Solar water collector systems	9 D	Evaluated prototype Demonstration project under evaluation	Manufacturers of facade insulation system, and of plastic capillary piping: product development TRNSYS 14.2
Solar air collector systems	10 S	Qualified concept and system model	Facade construction company: ventilated – facade development TrnsAir (TRNSYS extension)
	11 CH	Preliminary design for a renovation project constructed in August 1999	Building contractor TrnsAir (TRNSYS extension)
Daylight	12 US	System performance characterisation R&D under way to look at integrated solutions Skylights and control commercially available	Manufacturer of skylight, and lighting control: product information and supplier Lumen Micro 7.5 (light analysis) DOE-2 & Visual DOE 2.6 (energy analysis) Physical model
	13 DK	Qualified renovation design Technical components are available on the market	Manufacturer of the Heliostat system: product information and supplier Radiance Physical model

Table 8-2: Overview of the project status at the time of reporting, the industry involvement and design tools used

8.2 Renovation reasons, energy savings and solar energy gains

Concept group, project number and country of origin	Renovation reasons	Energy savings (reduced transmission losses by the renovation measure)	Solar energy gains (utilised energy produced by the solar system)
Glazed balcony and mechanical ventilation	1 D	Cold bridge problems Hygienic aspects (mould) Facade degradation High energy demands Unattractive apartments Unattractive architecture	Heat energy demand reduction from 100 kWh to 50 kWh per m ² and heating season (calculated values, total renovation). Energy savings and solar energy gains from the balcony were not specifically evaluated.
	2 DK	As above plus poor ventilation (Traffic) noise problems	900 to 1400 kWh per apartment and heating season (calculated values). 1100 to 1600 kWh per apartment and heating season (calculated values).
	3 NL	Poor ventilation (air quality problem) Upgrading of existing settlement Energy conservation	Heat energy demand reduction of 30 kWh per m ² heated floor area and heating season (calculated values for an apartment size of 70 m ²). Solar energy gains were not specifically evaluated.
	4 CH	Facade renovation Extension of apartment area / living space Reduction of energy demand	Heat energy demand reduction of 15 to 20 kWh per m ² heated floor area and heating season for typical apartments. 5 to 15 kWh per m ² heated floor area and heating season for typical apartments.
Solar wall heating with Transparent Insulation	5 D	Facade degradation High energy demand Low thermal comfort Unpleasant appearance	Reduction of transmission losses of 30 to 50 kWh per m ² of TI covered facade, depending on the state of the existing wall. Solar gains were not specifically evaluated.
	6 CH D	Facade renovation Facade insulation Renewal of DHW system (for design option)	Reduction of transmission losses of 30 to 50 kWh per m ² of TI covered facade, depending on the state of the existing wall. Solar gains of 20 to 50 kWh per m ² of covered TI facade area per heating season. For thermal collector design option: 100 to 150 kWh per m ² of facade area per year.
	7 CH D	Facade renovation Facade insulation	Reduction of transmission losses of 40 to 70 kWh per m ² of TI covered facade, depending on the state of the existing wall. Solar gains were not specifically evaluated.
	8 NL	Poor local insulation with possible moisture problem Energy conservation Upgrading exterior	Reduction of transmission losses of up to 35 kWh per m of TI covered floor edge per heating season. Solar gains of up to 10 kWh per m of TI covered floor edge per heating season.

Table 8-3: Renovation reasons, energy savings and solar energy gain

Concept group, project number and country of origin	Renovation reasons	Energy savings (reduced transmission losses by the renovation measure)	Solar energy gains (utilised energy produced by the solar system)
Solar water collector systems 9 D	Facade degradation High heating energy demand Low thermal comfort High energy demand for DHW	Transmission losses are determined by the insulation layer and not significantly influenced by the solar absorber layer	Solar energy gain results from testing available but not yet in a published form (diploma work).
Solar air collector systems	10 S	Bad condition of external building skin High energy demand for space heating Moisture and/or mould problems	No additional solar gains as no heat exchanger loop for DHW is planned.
	11 CH	Deteriorated facades Poor thermal insulation New facade cover with thermal insulation	Solar energy gains are mainly harvested during summer time for preheating DHW. The amount has not been evaluated in this project.
Daylight	12 US	Decrease energy use for lighting Increase occupants visual comfort Conventional re-roofing Energy-efficient lighting upgrade	Daylight compensates up to 30% of the electrical energy in building areas improved with skylights and light ducts.
	13 DK	Supplement to any major renovation of the building interior	Not evaluated in general – depends on too many individual parameters.

Table 8-3 (cont.): Renovation reasons, energy savings and solar energy gains

8.3 Market aspects

Concept group, project number and country of origin	Building type	Additional benefits	Application potential	Cost target in Euro (€)	
Glazed balcony and mechanical ventilation	1 D	Residential housing blocks	User acceptance due to added space External noise reduction More attractive apartments for letting	For special balcony situations were costs are compensated by avoided conventional renovation measures. No quantity estimations.	Cost must be within the budget for the avoided conventional renovation measures. (cost of demonstration project < € 7000 per apartment)
	2 DK	Multi-storey houses Detached houses Row houses	Increased living area More attractive apartments/building for letting	10% to 15% of multi-storey housing stock in Denmark. Technical potential: 20% of all renovated housing stock in Denmark.	Less than € 6700 per balcony (experience based on a demonstration project).
	3 NL	Pre-war apartment block requiring new balconies Post-war apartment blocks that need upgrading	Solved maintenance problems Improved architectural image Enhanced use of space Improve property status	Not evaluated for NL.	Marginal cost of € 300 to € 600 per m ² of balcony envelope area seems acceptable.
	4 CH	Apartment buildings with balconies and mechanical ventilation systems	Improved comfort by controlled air flow in the apartment	Subset of the potential for glazed balconies, only, Quantity not further estimated.	Marginal cost of € 700 – 1000 per apartment are acceptable for measures to use solar gains of the glazed balcony to preheat fresh air.
Solar wall heating with Transparent Insulation	5 D	Residential buildings with south oriented, high density (> 1200 kg/m ³) walls without existing insulation	Increased comfort	Technical potential (suitable buildings with existing overhangs): Approximately 80 000 m ² TI facade per year (A, CH, D).	No additional cost for situations with existing overhangs.
	6 CH D	Apartment buildings Office buildings (with multi-functional facade systems)	Improved comfort	Technical potential as for other solar wall heating systems with TI. (Current market volume is 1000 – 3000 m ² in A, CH, DE per year.)	Cost for ventilation control must be less than for the conventional solar gain control systems such as blinds (< € 100 / m ²).
	7 CH D	Single family home Apartment building Industrial hall, storehouse Public service building	Improved comfort, especially when applied to the external walls of bathrooms etc.	The technical potential are the south oriented, unshaded and sufficient high density mass walls of most massive buildings (more than 500 000 m ² per year in A, CH, D)	Cost target of the system is € 280 per m ² of facade area for standardised elements of around 5.5 m ² (2 m width and one storey height).

Table 8-4: Summary of the market aspects

Concept group, project number and country of origin	Building type	Additional benefits	Application potential	Cost target	
Solar wall heating with Transparent Insulation 8 NL	Buildings with non insulated cavity walls with exposed floor slabs	Thermal comfort Improved architectural image	Large theoretical potential also for east and west oriented facades. About 10 % of the total conventional compound insulation market in NL.	The Dutch market would accept cost of € 140 per m ² where the actual cost is about € 230 per m ² .	
Solar water collector systems 9 D	Residential buildings with west or south-west oriented external walls Buildings with central DHW system	Not yet determined	Not yet determined; depends on the cost/performance ratio compared to state-of-the art solar collector systems.	Additional cost of € 50 per m ² compared to a conventional insulation and facade finishing system.	
Solar air collector systems	10 S	Small to medium size multifamily houses Small office buildings	Increased thermal comfort	Technical potential in Sweden for double envelope: 1 000 000 m ² (total existing building stock).	Marginal cost (compared to conventional facade renovation) should amount to € ~ 100 per m ² or € 20 per m ² facade in order to be interesting.
	11 CH	Apartment buildings with poorly insulated mass walls	Thermal comfort Preheating of DHW	Technical potential for double envelope in Switzerland is several 100 000 m ² per year.	Market potential and acceptable cost not evaluated.
Daylight	12 US	All buildings Specially suitable for daytime occupied commercial or industrial buildings	Improved occupant's visual comfort resulting in increased productivity.	High: Most of the commercial buildings in the US have interior spaces that do not profit from daylight.	Not applicable in a generalised manner.
	13 DK	All buildings with large distances from the facade to the core	Improve visual comfort Daylight spaces provide a more friendly impression to the occupants.	Not evaluated	Depends on the building situation. Investment costs must be covered by the increased building value (rent) over a systems lifetime of 20 – 25 years.

Table 8-4 (cont.): Summary of the market aspects

8.4 Innovation and results

Concept group, project number and country of origin	Main innovation goals	Reported results	Comments	
Glazed balcony and mechanical ventilation	1 D	Economic system optimisation	The total investment of € 7650 per apartment (balcony and ventilation system) is comparable to conventional renovation measures. Calculated energy savings are approximately 4 000 kWh/a per apartment. With 5% interest rate and 20 years lifetime (annuity of 0,08) this result in € 0,15 per kWh.	It is a good result to reach the cost level of conventional renovation per saved energy unit.
	2 DK	Energy savings Improved comfort Low sensitivity of energy demand concerning user behaviour	Preliminary monitoring show significant energy savings Improved visual and thermal comfort Improved daylight conditions Cost target has been reached	Successful implementation of the glazed balcony renovation concept with systems optimised for the specific situations. The combination with mechanical ventilation system is not implemented.
	3 NL	Ventilation concept with low dependency on user behaviour	Conceptual design based on evaluated ventilation components	The evaluation has shown that there is a potential for more robust renovation designs with new but already available components.
	4 CH	Improved solar gains by combination of existing systems	Improved gains of 20 to 35 kWh per m ² heated floor area per heating season (calculated values, depending on HV system). Cost calculation shows equivalent energy cost between € 0,11 and € 0,14 per kWh at different investment levels.	The calculated improvement in solar energy gains is significant but needs to be verified in reality.
Solar wall heating with Transparent Insulation	5 D	Improved summer comfort (with solar wall heating)	For the same area of solar wall heating, the summer gains are reduced by 40%. For the same amount of solar energy gains during December the summer gains may be reduced by approximately 30%.	Example of a "simple" concept taking advantage of the existing situation that improves the use of solar energy without additional cost.
	6 CH D	No external movable parts for gain control (of solar wall heating system)	Natural ventilation of absorber during off heating season resulting in total energy gains of less than 12%. This is sufficiently low for most sensible large area solar wall heating applications.	Although the evaluated technique may improve the acceptance of solar wall heating the potential to lower the cost by this means are not clear, yet.
	7 CH D	Reduction of investment cost and equivalent energy cost for solar wall heating gains	Investment cost below € 200 per m ² solar wall heating (compared to € 400 per m ² for reference system). Heat energy gains of 70 kWh/a per m ² solar wall heating result in equivalent energy cost of € 0,25 per kWh (compared to € 0,30 per kWh for reference system)	This project shows that developments in materials technology can be an important driver for cost reduction on the component level and for system cost optimisation

Table 8-5: Main innovation goals and achieved results of the projects

Concept group, project number and country of origin	Main innovation goals	Reported results	Comments
Solar wall heating with Transparent Insulation 8 NL	Adaptation of a solar concept (solar wall heating) to solve thermal bridge problem	The evaluation shows that the cold bridge can be fully eliminated.	Because of the potential of this concept further cost and system optimisation would be worthwhile.
Solar water collector systems 9 D	Low cost system	Target of additional cost of € 50 per m ² facade for the solar collector. The project was not in the stage to prove the reach of this aim.	Unglazed and non-selective solar absorbers for water heating must have real cheap investment cost to be viable in central European climate.
Solar air collector systems	10 S	Optimisation of system parameters (design guidelines)	The concept of using solar heated air to reduce the transmission losses of a building is very intriguing, especially for renovation applications. It will be very interesting to learn about the operation experiences of these projects.
	11 CH	Improved design of technical components for the system	
Daylight	12 US	Implementation of advanced window components for improved lighting concept	It is important to note that improved use of daylight require advanced control systems.
	13 DK	Utilisation of heliostats for apartment buildings	Light guiding system work only when direct sunlight is available. Advanced control of the artificial light is required to take advantage of the natural light.

Table 8-5 (cont.): Main innovation goals and achieved results of the projects

9 Catalogue of Concepts and Systems

In the following section thirteen projects on the improvement of solar renovation concepts and systems followed under Subtask F are documented. Despite the large variety of the projects, it was the aim to report about the projects in uniform way.

The reporting scheme is divided into four blocks:

- **Specification:** Rationale for the intended concept and/or system, description of the concept and general information about the project
- **Development:** Status of the project and the involved partners
- **Market:** Market aspects of the involved services and products
- **Evaluation:** Report on the scientific and/or technical work of the project, including evaluation model and used evaluation tools, prototype or product description, results from calculations and/or measurement and final conclusion.

9.1 Advanced glazed balconies (D)

Specification

Concept description

Glazed balconies are an attractive concept in the renovation of apartment buildings. Basic investigations concerning the energy efficiency effects and major benefits of glazed balconies were performed with IEA SHC Programme Task 20 Subtask A demonstration projects and simulation work within Subtask B. A next step for integrating glazed balconies into a whole renovation design with the apartment mechanical systems is the combination of a glazed balcony with a mechanical exhaust air system for the apartment. Ambient air is supplied to the apartment via the balcony and thereby preheated by solar gains or recovery of transmission losses from the apartment. This system approach increases the energy savings. On the other hand the air temperature in the balcony is decreased thereby reducing the value as additional space for the occupants. However, in this concept, airflow rates are adjusted to a low level for energy savings and thermal comfort reasons.

The concept will be analysed for a 14-story apartment building in Freiburg, Germany built in 1970 and renovated in 1998. Design and simulation work on energy savings, temperatures, cold bridges and daylighting aspects are ongoing at the Fraunhofer ISE, Solar Building Design Group in Freiburg, Germany.



Figure 1: View of the apartment building Krozinger-Str. 4 before renovation.

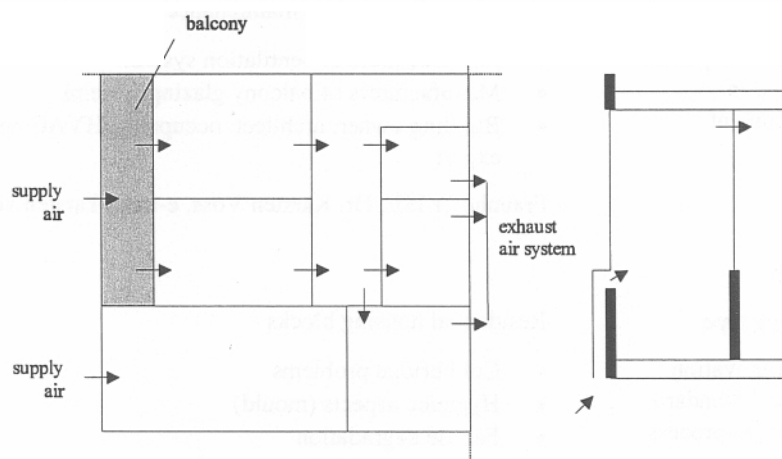

Figure 2: Typical apartment floor plan and airflow; section of balcony.

Specific energy savings/energy gain	<ul style="list-style-type: none">• Space heating demand before renovation averaged over 4 years in all 84 apartments: 100 kWh/(m².a)• Expectation for standard renovation combined with solar renovation is a heating demand reduction of 50%: approximately 50 kWh/(m².a)
Innovative aspects for renovation	<ul style="list-style-type: none">• Combination of glazed balcony and exhaust air ventilation• Economic system optimisation• Evaluation of comfort and user acceptance aspects in ventilated balconies• Cold bridge reduction compared to conventional renovation• Introduction of air preheating by a specially designed parapet of the balcony
Critical aspects	<ul style="list-style-type: none">• User behaviour effects on energy savings• Condensation of moisture from the apartment on the glazed balcony windows• Maintenance of glazed balconies in "high rise" buildings• Effects of wind pressure on the performance of the balcony / ventilation system• Static strength of balcony structure
References	<ul style="list-style-type: none">• IEA SHCP Task 20 brochure: Glazed Balconies in Building Renovation• IEA SHCP Task 20 report on STB• IEA SHCP Task 20 report on STC• BEW (CH) report: Sanierungsmassnahme Verglaste Balkone• Systemuntersuchung Balkonverglasung zur Sanierung des Hochhauses Freiburg-Krozing Str. 4, Fraunhofer ISE, TOS-1-1998-VK05, 1998

Development

Development status	<ul style="list-style-type: none">• Partly qualified concept• Design phase, to constructed in 1998/99, completion in spring 1999• Monitoring and questionnaires results will be analysed to gain initial experiences from the combined approach of controlled ventilation with glazing a balcony
Involved Systems / Components	<ul style="list-style-type: none">• Supply and exhaust air valves• Central exhaust fan for 14 apartments• Single or double glazed balcony glazing with non insulated frame• Low cost "air collector" in the parapet of the balcony (proposal)
Required technical improvements / development focus	<ul style="list-style-type: none">• Design of a new standard renovation for this building class for the building owner• Whole building renovation approach• High degree of integration of the occupants in the design process, the work on site and the system maintenance
Type of companies involved in development	<ul style="list-style-type: none">• Manufacturers of ventilation systems• Manufacturers of balcony glazing systems• Building owner, architect, occupants, HVAC engineer, IEA SHCP Task 20 expert
Contact	Fraunhofer ISE, Dr. Karsten Voss, e-mail: karsten.voss@ise.thg.de

Market

Building type	Residential housing blocks
Main renovation reasons / Standard renovation process	<ul style="list-style-type: none">• Cold bridge problems• Hygienic aspects (mould)• Facade degradation• High energy demand• Unattractive apartments• Unattractive architecture

Application potential	Renovation cases where the existing windows behind the balcony can be kept in place due to sufficient quality and conditions.
Cost target	Renovation with glazed balconies and controlled ventilation should not exceed the costs of replacing the existing windows including renovation of the balconies and controlled ventilation.
Additional benefits	<ul style="list-style-type: none"> • High user acceptance due to the value of the added space • External noise reduction, e.g. noise by wind • The increased standard of the apartments helps to keep occupants in urban quarters with high population density
Contractor/builder / additionally required experts	<ul style="list-style-type: none"> • Metal facade company • HVAC engineer
Application examples	<ul style="list-style-type: none"> • Multi-family building in Freiburg, Germany, Weingarten district • Conventional renovated buildings and buildings still to be renovated are in the same urban quarter (renovation district)

Concept Evaluation

Model description	<ul style="list-style-type: none"> • Thermal modelling was done with a detailed 6 zone model of a selected apartment of about 80 m² heated floor area (refer to the floor plan shown at the beginning of this description) including simplified air flow modelling according to a constant flow through the apartment induced by the ventilation system. Solar radiation normally absorbed on the balcony surfaces by wing walls and overhangs and lost to the ambient can be used to preheat ventilation air. • Air change rates in the apartment are set to levels between 0.3 and 0.5 air changes per hour (equivalent to 30 – 50 m³ per person per hour) • 2-dimensional heat flow in the balcony was modelled without taking into account the induced airflow by the ventilation system (programme simplification) • Daylight calculations take into account the effect of the optical properties of the glazing selected as well as shading by overhangs (balcony ceiling) and wing walls (balcony side walls)
Parameters	<ul style="list-style-type: none"> • Balcony glazing and frame type • Ventilation and infiltration rates • Opaque insulation thickness
Evaluation Criteria	<ul style="list-style-type: none"> • Thermal bridge effects • Energy savings • Thermal comfort • Daylight level • Condensation • Noise
Evaluation Tool(s)	<ul style="list-style-type: none"> • TRNSYS 14.2(thermal building simulation) • THERM (2-dimensional heat flow) • Radiance (daylight)

Evaluation Results

Results Criteria 1

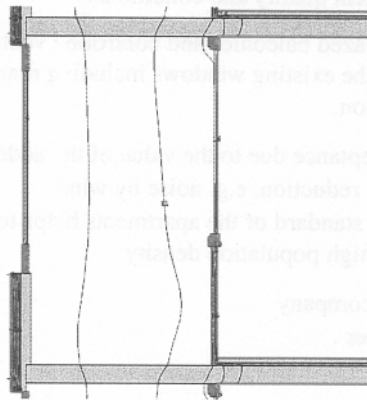

Figure 3: Isothermal lines.

Thermal bridges

The 2-D heat flow calculations show that the chosen balcony glazing (double glazing) can reduce the heat loss from the room to the ambient more (70% savings) than in the case of only replacing the windows with low-e coated double glazing (50% savings).

Note: The heat loss will increase when the air is supplied via the balcony.

Results Criteria 2

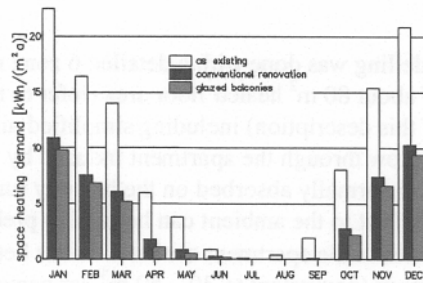

Figure 4: Monthly space heating demand.

Energy Savings

TRNSYS calculations (6-zone model including airflow) for a selected, south oriented apartment have shown an energy saving potential of 62% compared to the existing situation. The graph shows the calculated savings for the selected balcony glazing systems (double-glazing) including airflow compared to the situation before renovation.

Results Criteria 3

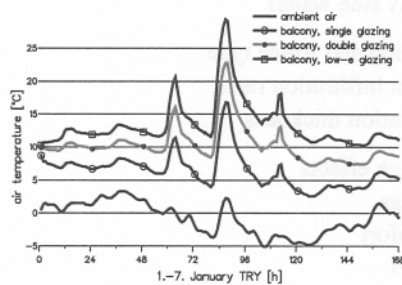

Figure 5: Hourly air temperatures in the balcony with controlled ventilation.

Comfort

Temperatures below freezing may occur in the balcony when single glass is used as the balcony glazing system. Double-glazing can "guarantee" temperatures above freezing (including airflow). Introducing the airflow via the balcony decreases the temperature level, thereby decreasing the comfort level.

Results Criteria 4

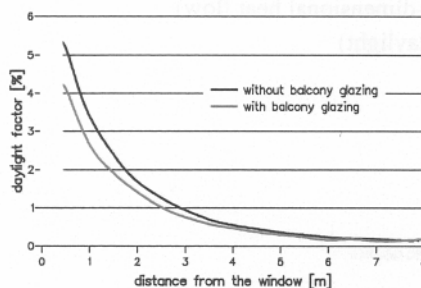

Figure 6: Daylight factor at desk level.

Daylighting (simulation results from Radiance)

The level of daylight is insufficient in the apartments with deep rooms and balconies attached (8 m). This situation worsens in the glazed balcony case (refer to the graph). Due to the wish of the occupants, balcony glazing will still be applied in these apartments.

Results Criteria 5

Condensation

Experiences from an initial full-scale system test in a selected apartment show that condensation may occur when using single glass or coated single glass (hard coating). This happens in the case of open windows from the apartment to the balcony, especially from the kitchen. The mechanical ventilation system with air supply via the balcony can not override this effect at low airflow rates.

We suggested not glazing the balcony of apartments where the kitchen is attached to the balcony. Due to the occupant wishes, balcony glazing will still be applied.

Results Criteria 6

Noise

The unintended use of the new space may create noise problems because balconies do not have a noise protection layer on the floor or on walls between balconies. Therefore problems with neighbours may occur as the balcony is more often used as integral part of an apartment. Noise problems resulting from unintended use is likely to increase as the thermal performance of the balcony increases (low-e glass, thermally broken frames, etc.).

Conclusions

The chosen building in Freiburg, Germany is renovated in 1998/99 according to the findings during the concept phase. The specific renovation investment costs are assumed to be lower compared to similar projects in the same urban quarter with a conventional renovation approach. The most important aspect is the high user acceptance for the renovation with glazed balconies. Experiences will show if the high expectations of the occupants will be fulfilled.

Glazing the balconies instead of removing the existing windows allows renovation without work inside the apartments. This is a practical advantage so that the renovation schedule will not need to be co-ordinated with occupant schedules.

Component Evaluation

Balcony glazing

The selected balcony glazing for the project is a double glazing (not low-e) with a metal frame without thermal separation.

Steel reinforcement

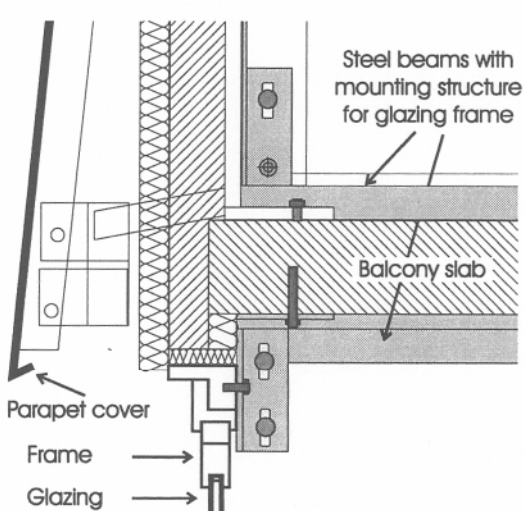

The existing balcony structure was insufficient to bear the additional wind load of the new glazing. Thus, a steel reinforcement was necessary to anchor the glazing frame on facade.

Reinforcement was achieved using horizontal steel beams in the floor and on the ceiling corners of every balcony.

Figure 7: Horizontal section of the balcony parapet with load bearing structure.

User aspects

- Operation
- Use of the balcony
- Maintenance, cleaning
- Instruction of the tenants

Cost evaluation

- The total investment for the renovation will be E 350 per m² of floor area and roughly equal to the conventionally renovated buildings in the same quarter
- About E 80 per m² floor area are invested in the renovation of the balcony including the folding glazing, the insulation of the parapet and the supporting metal construction (23% of the budget). This is equal to an investment of typically E 7000 per apartment.
- The controlled ventilation will cost approximately 650 Euro per apartment.

Conclusions

- The integrated design evaluation showed that the combination of an apartment ventilation system with preheating a large part of the supply air in a glazed balcony solves or reduces many of typical renovation problems. On the other hand, simulation work underlined the complexity of the studies needed to gain an overview of the performance and to compare several options (e.g. heat bridge calculations and daylight studies).
- Because of this complexity, it is recommended that easy-to-use guidelines for constructing vented glazed balcony systems should focus on specific building types.
- The increase in solar gains by the combination of the glazed balcony and the ventilation system compared to the situation with a glazed balcony without ventilation air preheat only was not evaluated explicitly. (Because the exhaust ventilation system was required anyway, such an option was not the customer's foremost interest.)
- The air flow through the balcony reduces the comfort level in the balcony area by decreasing the air temperature. This fact was not considered in the beginning of the studies and was found as a disadvantage compared to the unvented balcony.
- An unresolved issue is the problem of the function of the balcony as a smoking area. (With changing habits and increased health concerns, the balcony becomes the last resort for smokers in the apartments.) Occupants must prevent smoke from entering the apartment by opening the balcony glazing if and when the balcony area is used as a smoking zone.

9.2 Advanced glazed balcony (DK)

Specification

Concept description

In this study, the advanced glazed balconies are designed in a way that make them sturdy against unintended use such as heating the balconies individually with small air heaters. This is achieved by using gas filled low-e double glazings and by insulating the parapets.

Studies from the pre-design phase show that designs with large glazing areas in the South facade are attractive. The analyses indicate that because of the very low U-value of the glazings ($U = 1.15 \text{ W}/(\text{m}^2 \cdot \text{K})$) substantial energy savings will still be possible. This holds even if using very large glazed areas (up to 85% of the facade area of the balcony). For less insulating glazings, such large glazing areas will mean that the possible energy savings are reduced significantly when the glazing area increases above 50% of the facade area of the balcony.

In connection to the advanced glazed balconies, ventilated solar walls are integrated in the parapet. These are used for preheating the ventilation air before it enters the living area. The design of these solar walls is very simple as the fresh air just flows through an air gap between a dark cladding of the parapet and a covering layer of glass. Thus, the ventilated solar walls are established almost without any extra construction costs compared to the insulation and covering of the parapet which will be made anyway. Also the control of the airflow is very simple as this is regulated by the centrally controlled exhaust air system. In cold periods with only very small solar gains the fresh air will be preheated in the radiator integrated fresh air in-lets.

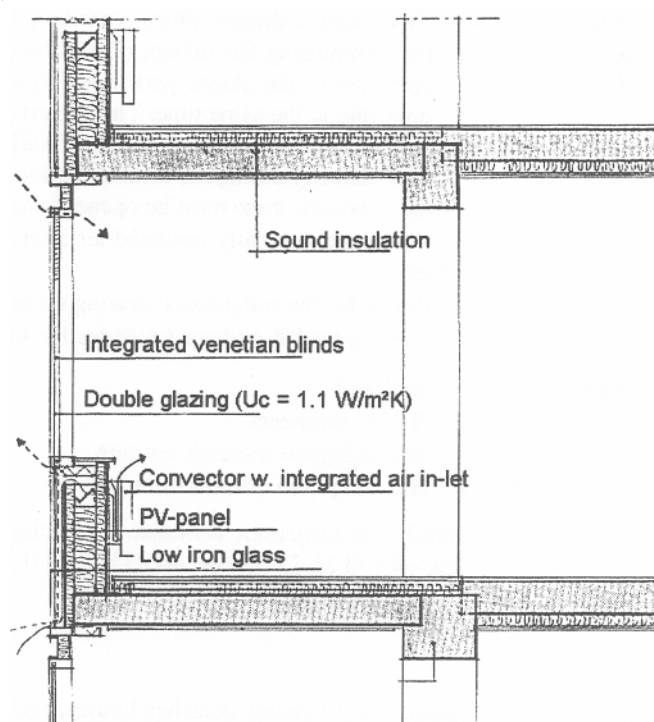

Figure 1: Vertical cross section of advanced glazed balcony.

Specific energy savings/energy gain

From the pre-design studies, annual energy savings of between 2 000 — 3 000 kWh per apartment can be expected for the actual design (— 55% from real solar gains and — 45% from reduced transmission losses, South facing facade). Depending on the glazing percentage, the distribution of savings from real solar gains and from transmission losses will vary (the higher the glazing percentage the higher the savings from real solar gain vice versa). However, the total savings will be almost unchanged.

Innovative aspects for renovation	<ul style="list-style-type: none">• Optimised glazing types and glazing areas• Combinations with exhaust air system.• Combinations with ventilated solar walls• Optimised design of advanced glazed balconies that are sturdy against unintended use.
Critical aspects	<ul style="list-style-type: none">• <i>Parapet</i>: Elimination of cold bridges, leaving the opportunity open for air inlets, piping for water based system and cabling for PV-systems.• <i>Glazing part</i>: – 75% of the window area must be operable.
References	<ul style="list-style-type: none">• IEA SHCP Task 20 reports and brochures• "Helhedsorienteret bygningsrenovering med solenergi – Pilotprojekt Engelsby, Flensburg" (working title) by Staermose & Isager Architects, Esbensen Engineers, Birch & Kroghoe Engineers. Published in Summer 1999, in Danish.

Development

Development status	<ul style="list-style-type: none">• Construction completed• The project was awarded with a first price in a competition (Solar '99) for exemplary solar energy projects in Germany.
Involved Systems/Components	<ul style="list-style-type: none">• Highly insulated glazings• Simple ventilated solar wall• Radiator integrated fresh air in-lets• Demand controlled ventilation
Required technical improvements / development focus	<ul style="list-style-type: none">• To develop a design, which provides a very slim framing system for the glazing part minimising the amount of cold bridges and still providing a high degree of openness of the glazed part. Approximately 75% of the window area must be openable at the same time. This is partly due to fire regulations (escape routes) and the wishes from the tenants of still being able to enjoy the qualities of an open balcony during the summer period. To make it easy for the tenants to clean the windows, these must be opened inwards.• To ensure thermally insulated air inlets for the radiator integrated fresh air in-lets.• Piping for the water based heating system (integrated in the parapet).• Cabling for PV-systems (integrated in the parapet).
Type of companies involved in development	<ul style="list-style-type: none">• Architect• HVAC engineers• Technological research institute• Facade system manufacturer
Contact	Olaf Bruun Jorgensen, Esbensen Consulting Engineers, Tel: +45 33 26 73 00, fax: +45 33 26 73 01, E-mail: o.b.joergensen@esbensen.dk

Market

Building type	Multi storey housing, detached houses, row houses etc. (renovation and new build)
Main renovation reasons / standard renovation process	<ul style="list-style-type: none">• High energy demand• Dissatisfying air quality• Cold bridges• Moisture damages• Facade degradation• Noise problems
Application potential	About 10 to 15% of the existing housing stock (multi storey housing) may benefit from this technology. The major part of the building stock being renovated is old multi storey housing. It is estimated that up to about 15% of the housings being

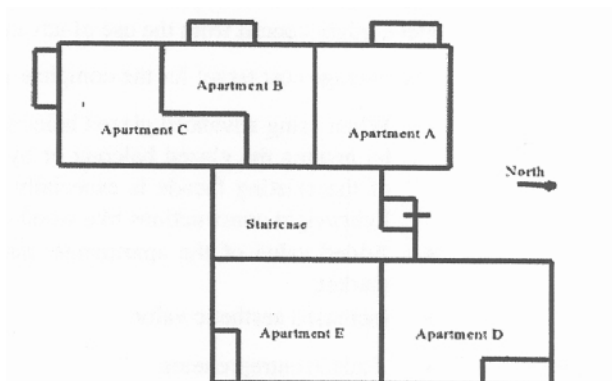

Figure 2: Floor plan for the different apartments.

Parameters

During the simulations the following parameters were varied:

Glazing types (U-value, light transmittance, g-value)

Four different glazing types were evaluated:

Single glazing, no framing, no sealing ($6.0 \text{ W}/(\text{m}^2 \cdot \text{K})$, 91%, 87%)

Single glazing, standard framing ($6.0 \text{ W}/(\text{m}^2 \cdot \text{K})$, 91%, 87%)

Double glazing, standard framing ($2.9 \text{ W}/(\text{m}^2 \cdot \text{K})$, 82%, 76%)

"Energy" glazing ($1.1 \text{ W}/(\text{m}^2 \cdot \text{K})$, 79% 59%)

Insulation level

Three different insulation levels were evaluated:

No insulation

Insulation of parapet between living room and balcony

120 mm insulation of parapet of balcony

Air changes

Two air changes were evaluated:

Standard building code ($35 \text{ l/s} - 0.72 \text{ h}$)

Humidity controlled ventilation (three levels 20 l/s , 60 l/s , 10 l/s , average -0.41 h^{-1})

Orientation

Three orientations and balcony types were modelled:

East ("inside" the facade)

South ("inside" and "outside" the facade)

West ("outside" the facade)

"Use of balcony"

11 scenarios of the use of the balconies were modelled:

No heating of the balconies

Heating in week-ends (9:00 – 18:00 or 14:00 – 22:00 or 18:00 – 22:00)

Heating on week days (9:00 – 18:00 or 14:00 – 22:00 or 18:00 – 22:00)

Heating all week (9:00 – 18:00 or 14:00 – 22:00 or 18:00 – 22:00)

Heating of the balconies 24 hours per day during the heating season

Evaluation Criteria's

- Energy savings
- Moisture content in facade and in indoor air
- Thermal comfort
- Daylight level
- Noise level (only from adjacent tenant as traffic noise is very limited)

Evaluation Tool(s)

- Tsb3C
- Adeline/Radiance
- DAYLIGHT

Concept Evaluation

Results Criteria 1 –
 Energy demand and savings

Heating demand and savings per apartment for different glazing types:

Heating demand	Not heated balcony			Heated balcony (heated for 24h per day)		
	kWh/a	kWh/(m ² .a)	savings	kWh/a	kWh/(m ² .a)	savings
1 layer of "open" glass, insulated back wall	2 497	49	27 %	10 922	192	- 220 %
1 layer of glass with non-insulated parapet	2 622	52	23 %	6 264	110	- 83 %
Gas filled low-e double glazing with insulated parapet	2 078	41	39 %	2 446	3	28 %
Double glazing with insulated parapet	2 360	46	31 %	3 724	65	- 9 %
Double glazing with non-insulated parapet	2 683	53	22 %	7 735	136	- 126 %

The largest energy savings are achieved when using the design with "energy" glazings and insulation of the parapets. This is the case for the unheated as well as for the heated balconies. However, this design is also by far the most expensive design. For the unheated balconies, even the design with a very "open" glazing offers significant savings. This is due to the solar gains but also due to the insulation of the parapet between the balcony and the living room next to it.

The possible energy savings do more or less not vary with the glazing percentage. Savings for 15% glazing are almost identical to the possible savings for 75% glazing. Therefore, the glazing areas in the balconies are quite high (– 65%).

From the different scenarios for heating the balcony it is seen that even for partly heating of the balconies, there is a risk of increasing the energy demand for space heating and ventilation by up to 100% instead of providing energy savings. The only design that always provides energy savings is the design using windows with gas filled low-e double-glazing and insulated parapets. Even when heating such balconies, the energy demand for space heating is lower than 72% of the heating demand before glazing the balcony.

Results Criteria 2 –
 Moisture content and relative air humidity

The reduction of the relative humidity from adding the advanced glazed balcony is illustrated below.

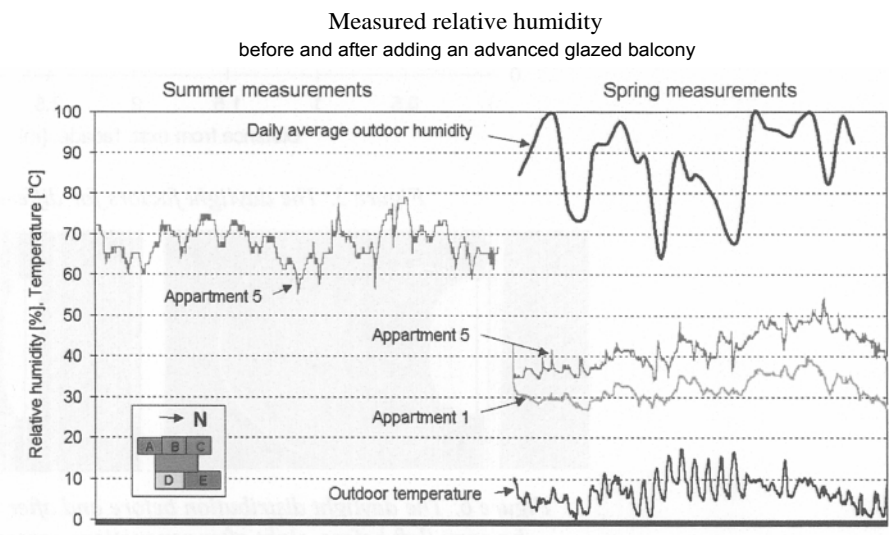

Figure 3: Measured humidity levels in apartments before and after renovation in apartment A and D (see corresponding floor plan of figure 2).

Summer measurements are made before adding the advanced glazed balcony. Spring measurements are made after adding the glazed balcony.

Results Criteria 3 —
Thermal comfort

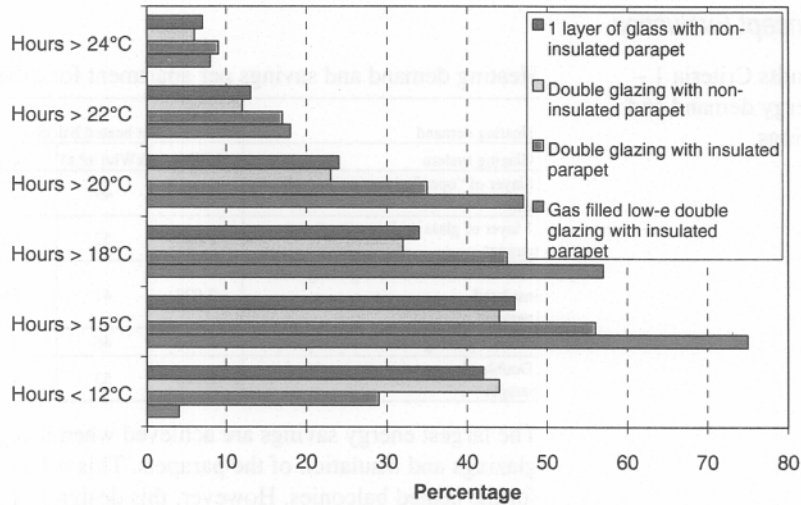

Figure 4: Distribution of the room temperature during the heating season depending on the glazing type and insulation level of the parapet (simulations).

Results Criteria 4 —
Daylight

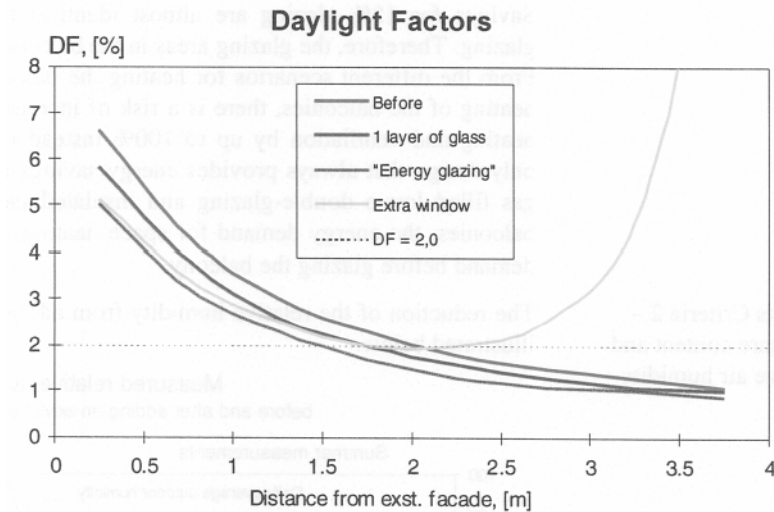

Figure 5: The daylight factors for different glazings.

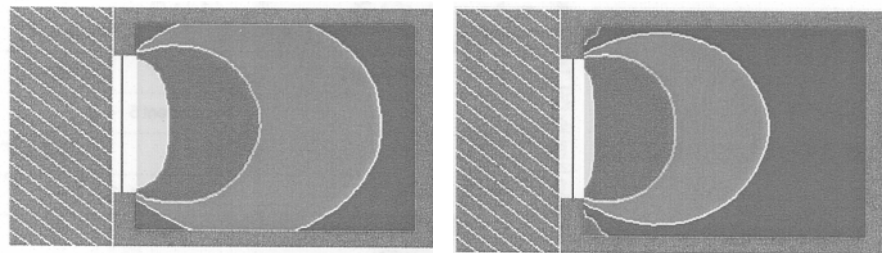

Figure 6: The daylight distribution before and after the adding of the glazed balcony (left before, right after renovation; contour levels see figure 7).

It is seen that the daylight level is reduced significantly, but also that the daylight level was quite low even before adding the glazing on the balcony. Furthermore, it is seen that the daylight is distributed more evenly after adding the glazed balcony. As a consequence, a new window was added to some of those rooms that had only one window before the renovation.

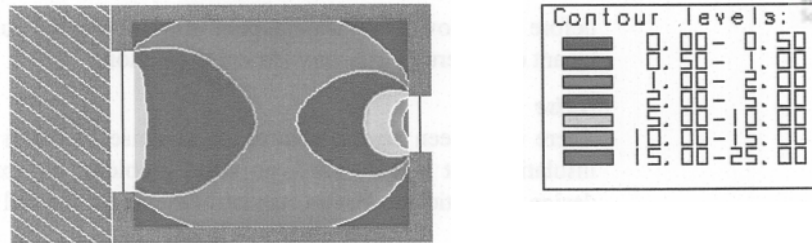

Figure 7: Daylight distribution after adding a glazed balcony and an extra window.

As expected, it is seen that the daylight level is increased significantly compared to the situation before adding the glazed balcony.

Result Criteria 5 –
Noise level

No detailed studies of the noise level have been made yet. The results will mainly be reactions from the tenants.

Cost evaluation

The average cost target for the complete glazed balcony was £ 6 700 per balcony. This target was reached when implementing the glazed balcony in the renovation of the demonstration tower block during 1998. The client considers the cost satisfying.

Conclusions

From the analyses it is seen that the risk of increasing the energy demand is high when using poorly insulated glazed balconies. This is due to the risk of unintended use such as heating the balcony. This risk is partially avoided when using gas filled low-e double glazings and insulating the parapet of the balcony.

Energy

From the analyses, two designs are recommended:

- For the balconies that are placed "inside" the facade, the design with "energy" glazing and insulation of the external parapet is recommended. As this design will be very sturdy against unintended use such as heating because of the high insulation level and because heating the balcony will still offer significant energy savings for space heating and ventilation.
- For the balconies that are placed "outside" the facade, the design with the very "open" glazing is recommended. This design will also be very sturdy against unintended use because heating of the balcony will be difficult due to the very open design. Technically, these balconies would also benefit from the highly insulated solution but because of the large glazing areas such a design might be too expensive.

Moisture and relative humidity

From preliminary monitoring it is seen that the relative humidity on the balconies and in the apartments will be decreased significantly. It should be noted that these apartments are also provided with a demand controlled moisture regulated exhaust air ventilation system, which is the main reason for the decreased moisture content of the indoor air. However, the glazed balcony will also lead to an effective drying out of the moisture-damaged facades and concrete slabs at the balconies.

Thermal comfort

Simulations show that the thermal conditions in the balcony and in the apartments will be very attractive for the design used (insulated parapets and insulating glazings): The temperatures in the balcony during the heating season will be very pleasant and overheating during summer is avoided by opening the balcony. From previous pilot project it is known that the tenants are very pleased by the new advanced glazed balconies.

Daylight

As a result of the reduced amount of daylight in the rooms next to the balconies - especially in the East facing glazed balconies - it is recommended to take measures to increase the daylight level. In this case the best solution was to add a new window in the West facing exterior wall of this room. As the daylight level even

before the renovation was quite poor in this room, the building owner as well as the tenant considered this a very attractive solution.

Noise

There have been no experiences about noise problems yet. Because of the noise insulation that was installed, no noise problems are expected, as this part of the design is identical to known standard designs for footfall sound insulation..

Component Evaluation

Description component

For the balconies that are placed "inside" the facade the design with the gas filled low-e double glazings and insulation of the external parapet is used. The insulation is covered by sand blown glass. The windows are sliding and have an airtight sealing (right hand side of the building view of figure 9).

For the balconies "outside" the facade the design with 1 layer of glass is used. The parapet between the balcony and the living room is insulated. The parapets of the balcony glazing are made of sand blown glass. The windows are sliding and there are an open air gap between each glass pane.

In this specific project, neither ventilated solar walls nor PV-panels in the parapets are used.



Figure 9: Picture of installed advanced glazed balconies, Engelsby – Flensburg.

Evaluation Results

In general the targets that were set up regarding price, energy savings, comfort improvements and building integration have been achieved

Cost evaluation

The average cost target for the complete glazed balcony was €6 700 per balcony. This target was reached when implementing the glazed balcony in the renovation of the demonstration tower block during 1998. The client considers the cost satisfying. Even though comprehensive renovations have been carried out, it was not required to increase the rent for the tenants.

Conclusion

The concept development and the implementation, demonstration and evaluation of

the concept documents that it is possible to design cost-effective and architecturally attractive advanced glazed balconies for building renovation. It shows also that this measure provides significant energy savings, increased thermal and visual comfort, improved air quality and an effective protection against degradation of the building envelope.

9.3 Advanced ventilation strategy for glazed balconies (NL)

Specification

Concept description

Glazed balconies reduce transmission losses from an apartment because of the additional glass layer(s) used to enclose the balconies. Solar radiation is captured inside the glazed balcony or passes through to the adjacent space. Additional energy savings can be achieved if ventilation air is preheated using the solar radiation in the glazed balcony area and transmission losses within the glazed balcony are recovered.

This paper focuses on the ventilation strategies. Preheating ventilation air in glazed balconies requires a ventilation concept of the whole apartment: most ventilation air should enter through the glazed balcony by optimising the position of the vents in the facade. The concept is based on depressurising the apartment using mechanical exhaust ventilation in the bathroom, toilet and kitchen.

Vents that operate independently of wind pressure limit the airflow above 5 Pa pressure difference. If there is a pressure difference greater than 5 Pa, the vents limit the fresh air supply.

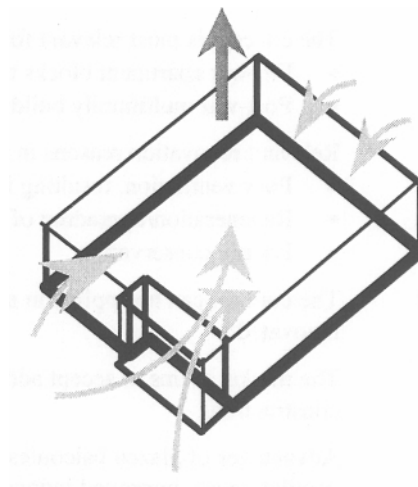

Figure 1: Schematic of the airflow through the apartment: intake by vents in the walls and the balcony and the extraction by a central exhaust system.

Specific energy savings/energy gain

The total saving of an optimised glazed balcony using preheated ventilation air in glazed balconies and application of low-e glazing is up to 30 kWh/(m².a) in an average apartment of 70 m².

Innovative aspects for renovation

The innovative aspects are

- Vents that operate independently from wind pressure will limit the fresh air supply.
- The concept is less dependent on user behaviour because bedrooms can be ventilated without disturbing the ventilation concept.

Critical aspects

Critical aspects are

- Achieved air tightness of renovated buildings
- Distribution of vents over facades and glazed balcony
- Type of glazing in glazed balcony and existing facade.

References

- Project Catharinaland in Den Haag, The Netherlands (glazed balconies).
- Project Reitse Hoeve in Tilburg, The Netherlands (glazed balconies).
- Manufacturer information wind-pressure independent vents.
- Subtask B contribution: development of advanced glazed balconies.

Development

Development status	Conceptual design: Evaluated prototype using existing products (glazed balconies, vents, mechanical ventilation) for the ventilation strategy.
Involved Systems/Components	<ul style="list-style-type: none">• Glazed balcony facade, single glass and low-e glazing.• Airtight building envelope• Vents that operate independently from wind pressure on all facades• Mechanical exhaust ventilation system
Type of companies involved in development	<ul style="list-style-type: none">• Energy consultants / HVAC engineer: specification of the ventilation strategy and product specification and commissioning• Manufacturer: product specifications and technical requirements
Required technical improvements / development focus	Key-improvements are <ul style="list-style-type: none">• Development of performance specifications for optimum use• Sensitivity analysis: renovation practice and (in)dependence on user behaviour

Market

Building type	The concept is most relevant for <ul style="list-style-type: none">• Pre-war apartment blocks that need additional balcony-type spaces• Post-war multifamily buildings that need to be upgraded
Main renovation reasons / Standard renovation process	Relevant renovation reasons in relation to this concept are <ul style="list-style-type: none">• Poor ventilation, resulting in moisture problems and low indoor air quality• Regeneration/upgrading of existing settlements• Energy conservation
Application potential	The concept can be applied in multi-family apartment blocks that need to be renovated.
Cost target	The market seems to accept added cost between €300 to €600 per m ² glazed construction.
Additional benefits	Advantages of glazed balconies: solar gains and energy conservation; preheating ventilation air; improved indoor climate; solving maintenance problems; improved architectural image, enhanced utility of space; improved status of property.
Contractor/builder/ additionally required experts	Energy consultants are required to specify and commission the ventilation concept.
Application examples	W/E Consultants evaluated the concept of vents that operate independently from wind pressure in the EC2000 project-monitoring programme: Tax Office Enschede. The vents were successful in controlling the airflow through an office building. Institutes such as TNO are testing the vents themselves.

Concept Evaluation

Model description

The apartment is a typical social housing apartment in the Netherlands. The floor area is 73 m². There are two bedrooms. The kitchen is open to the living room. Wall insulation is 0.37 W/(m².K). The glass U-value is 1.3 W/(m².K) and the window frame U-value is 2.4 W/(m².K).

The glazed balcony: Floor area is 5.4 m². Ventilation openings at the top and at the bottom of the balcony facade are equally distributed. Single-pane windows are used in the glazed balcony. The balcony is not heated. Variations were calculated using double-pane and low-e glazing.

The glazed balcony system performance was modelled for one apartment. The climate situation is assumed to have:

- 20% of the time north wind
- 30% of the time south wind
- 20% of the time east wind
- 30% of the time west wind

The used vents itself are wind-pressure independent, therefore the infiltration rate is less dependent from wind-pressure.

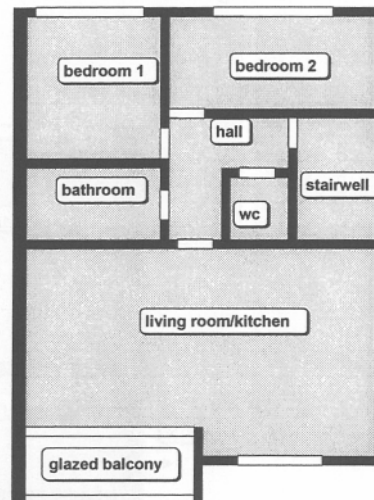

Figure 2: Floor plan for a typical apartment used for the evaluation model

Parameters

Specific set of parameters:

- Distribution of vents over the facades and the balcony
- Variations in the overall air tightness of the building envelope
- Single, double and low-e glazing for glazed balcony

Evaluation Criteria's

Evaluation criteria are

- Influence of the vent distribution on required ventilation rates in the apartment rooms
- Energy impact of balcony glazing types
- Energy impact of ventilation strategies

Evaluation Tool(s)

- Air change rate and ventilation distribution: MVRM 5.0 (multi-zone ventilation evaluation tool)
- Energy impact of balcony glazing type: Tsbi3
- Energy impact of ventilation strategies: TRNSYS

Table 1: Average airflow in/out apartment in m³/h with **high** air input through balcony.

	<i>total in</i>		<i>via vents</i>	<i>infiltration</i>
glazed balcony	116	51%	80	36
living room	12		0	12
stairwell	20		0	20
bedroom	44		30	14
bedroom	35		19	16
	<u>227</u>		<u>129</u>	<u>98</u>

Ventilation according to the Dutch building regulations. This corresponds to the highest speed of the mechanical exhaust ventilation. The mechanical exhaust ventilation is three speeds.

- Low speed: 4/9 of the Dutch building regulations
- Middle speed: 2/3 of the Dutch building regulations
- High speed: Corresponds to Dutch building regulations

The occupants use low speed 40% of the time, middle speed 50% of the time and high speed 10% of the time. This makes the average ventilation by mechanical exhaust system 140 m³/h.

Minimum airflow through glazed balcony

- Air tightness according to Dutch building regulations [$q_v(10)=50 \text{ dm}^3/\text{s}$]
- Air through glazed balcony: 30% of total airflow

In order to achieve this flow pattern, the distribution of vents should be as follows.
 Vents to outside:

- Living room: 30% of total vents area
- Bedroom 1 north: 35% of total vents area
- Bedroom 2 north: 30% of total vents area

Vents to glazed balcony:

- Living room: 5% of total vents area

By changing the distribution of vents over the facades and glazed balcony, the percentage of the total airflow through the glazed balcony changes from 51% to 30%.

Similar calculations under improved airtightness conditions [$q_v10 = 30 \text{ dm}^3/\text{s}$] show no principal difference, given the fact that the size of the vents was enlarged to achieve the same overall ventilation rate. The ventilation through vents is enlarged and the infiltration is smaller.

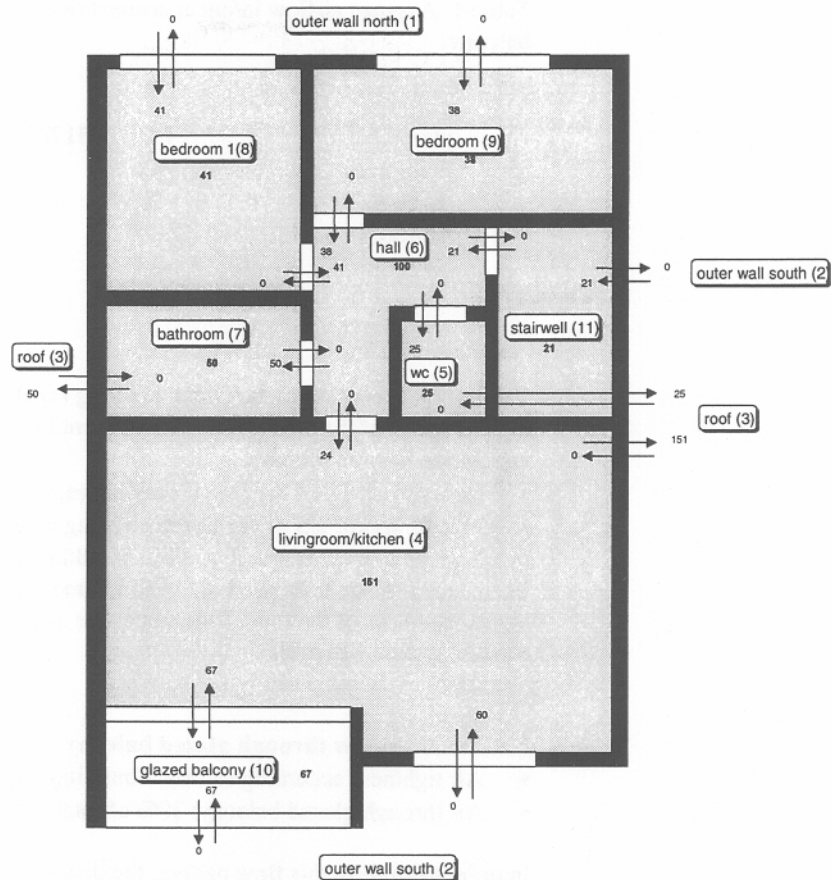

APARTMENT AT THE FIRST FLOOR

Figure 4: Air distribution with low air flow input through balcony (figures in brackets are room numbers in the simulation model).

Table 2: Average airflow in/out apartment in m³/h with **low** air input through balcony.

	total in		via vents	infiltration
glazed balcony	67	30%	25	42
living room	60		46	14
stairwell	21		0	21
bedroom	41		25	16
bedroom	38		22	16
	<u>227</u>		118	<u>109</u>

Ventilation according to the Dutch building regulations. This corresponds to the highest speed of the mechanical exhaust ventilation. The mechanical exhaust ventilation is three speeds:

Low speed: 4/9 of the Dutch building regulations

Middle speed: 2/3 of the Dutch building regulations

High speed: Corresponds to Dutch building regulations

The occupants use low speed 40% of the time, middle speed 50% of the time and high speed 10% of the time. This makes the average ventilation by mechanical exhaust system 140 m³/h.

Results Criterion 2
Energy impact of the
balcony glazing

The amount of exhausted air under average use of the mechanical exhaust system is 140 m³/h. The average amount of air which enters the apartment via the glazed balcony is 45 m³/h. When the glazed balcony is optimised this increases up to 77 m³/h.

The above results show that it is possible to set the rate of air preheated by the balcony in a wide range without disturbing the airflow pattern in the apartment.

Varying the glazing design results in different heat demands:

Heat demand solar renovation

- Lowest for low-e glazing in whole apartment, either in glazed balcony or in the existing facade.
- If double-glazing is applied, the best position for installation is in the existing facade (balcony-interior).
- If low-e glazing is applied to aligned balconies, the best position for installation is in the new facade (balcony-ambient), because of warmer preheated air.
- If low-e glazing is applied to external balconies, the best position for installation is in the existing facade (balcony-interior), because of the decreased transmission losses.

Temperatures

- Average outdoor temperature about 5°C
- Single glazed balcony temperature about 12°C
- Low-e glazing in existing facade and single glazing in balcony reduces temperature to 11°C
- Low-e glazing in new facade and single glazing in existing facade increases temperature to 15°C.

Reduced transmission losses: standard renovation vs. optimised renovation with glazed balconies

The expected energy savings for transmission losses by optimised renovation with glazed balcony in comparison with standard renovation can be calculated with the following formula:

$$Q_{\text{trans}} = \Sigma UA \times \text{degreehours} \quad (U: \text{U-value [W/(m}^2\text{.K)]}, A: \text{respective area [m]})$$

Area of glazing and wall between existing facade and balcony:

$$A_{\text{glazing}} = 4.5 \text{ m}^2$$

$$A_{\text{wall}} = 4.5 \text{ m}^2$$

Before renovation:

$$U_{\text{glazing}} = 5.0 \text{ W/(m}^2\text{.K)}$$

Standard renovation:

$$U_{\text{glazing}} = 2.8 \text{ W/(m}^2\text{.K)}$$

$$U_{\text{wall}} = 0.32 \text{ W/(m}^2\text{.K)}$$

Optimised renovation:

$$U_{\text{glazing}} = 1.6 \text{ W/(m}^2\text{.K)}$$

$$U_{\text{wall}} = 0.32 \text{ W/(m}^2\text{.K)}$$

Only transmission losses of the glazing and wall between the balcony and the living room are looked at. The wall and the glazing, which is not adjacent to the balcony, are left aside for the calculation. In this way the influence of the balcony only becomes visible.

Transmission losses before renovation (without balcony):

$$Q_{\text{tran}} = 4.5 (5.0 + 2.0) \times 71000 = 2244 \text{ kWh, i.e. } 31 \text{ kWh/m}^2$$

Transmission losses standard renovation (without balcony):
 $Q_{\text{tran}} = 4.5 (2.8 + 0.32) \times 71000 = 1016 \text{ kWh}$, i.e. 14 kWh/m^2

Transmission losses optimised renovation (with balcony):
 $Q_{\text{tran}} = 4.5 (1.6 + 0.32) \times 41000 = 352 \text{ kWh}$, i.e. 5 kWh/m^2

Standard renovation reduced transmission losses by 84%, i.e. 26 kWh/m^2 , in comparison with before renovation.

Optimised renovation reduces transmission losses by 65%, i.e. 9 kWh/m^2 , in comparison with standard renovation.

Transmission losses through balcony:

	Unit	before	standard	optimised
Uglazing	W/(m ² .K)	5.0	2.8	1.6
Uwall	W/(m ² .K)	2.0	0.32	0.32
Losses	kWh/a	2244	1016	352

Results Criterion 3

Energy impact of the vent and airflow distribution

The energy impact was not evaluated in detail, as no dynamic simulation tool allows straightforward simulation of energy flows specific to glazed balconies. Calculations using Tsbi3 indicated the energy saving, as performed under Subtask B of IEA SHC Programme Task 20. The same procedure can be used with TRNSYS.

The physical effects that could not be modelled straightforward, are
 Solar radiation into the glazed balcony and through to adjacent space
 Air flows depending on wind direction and wind pressure.

Preheating ventilation air: standard renovation vs. optimised renovation with glazed balcony

The expected energy savings for ventilation losses by optimised renovation with glazed balcony in comparison with standard renovation can be calculated with the following formula:

$$Q_{\text{vent}} = K \times \text{Flow rate} \times \text{degreehours} \quad (K: \text{density of air [kg/m}^3])$$

$$\text{Apartment} = 73 \text{ m}^2$$

Before renovation:

Outside air:

Degreehours: 71000 Kh

Flow rate = 140 m³/h

Standard renovation

Outside air:

Degreehours = 71000 Kh

Flow rate = 140 m³/h

Optimised renovation

Outside air:

Degreehours = 71000 Kh

Flow rate = 63 m³/h

Air from balcony:

Degreehours = 41000 Kh

Flow rate = 77 m³/h

Ventilation losses before renovation (without balcony):

$$Q_{\text{vent}} = 1.2 \times 140/3600 \times 71000 = 3324 \text{ kWh}$$
, i.e. 46 kWh/m^2

Ventilation losses standard renovation (without balcony):

$$Q_{vent} = 1.2 \times 140/3600 \times 71000 = 3324 \text{ kWh, i.e. } 46 \text{ kWh/m}^2$$

Ventilation losses optimised renovation (with balcony):

$$Q_{vent} = 1,2 \times 63/3600 \times 71000 + 1.2 \times 77/3600 \times 41000 = 2541 \text{ kWh, i.e. } 35 \text{ kWh/m}^2$$

Optimised renovation reduces ventilation losses by 25%, i.e. 11 kWh/m²

Ventilation losses through balcony:

	Unit	before	standard	optimised
Outside air	m ³ /h	140	140	63
Preheated air from balcony	m ³ /h	-	-	77
Losses	kWh/a	3324	3324	2541

Product information

Some manufacturers of wind-pressure independent vents are :

Heycop Systemen b.v.
 P.O. Box 416
 3990 GE Houten
 The Netherlands
 Internet: www.heykop.nl

Alusta b.v.
 P.O. Box 93
 4870 AB Etten-Leur
 The Netherlands
 Internet: www.alusta.nl

BUVA b.v.
 Postbus 29019
 3001 GA Rotterdam
 The Netherlands
 Internet: www.buva.nl

Conclusions

The energy performance of glazed balconies can be improved by applying low-e glazing either in the new balcony facade or in the existing facade, depending on the shape of the balcony and the required comfort conditions.

If low-e glazing is applied to aligned balconies, the best position for installation is in the new facade (balcony-ambient), because of warmer preheated air.

If low-e glazing is applied to external balconies, the best position for installation is in the existing facade (balcony-interior), because of the decreased transmission losses.

Preheating of ventilation air is the second option to improve the energy performance of apartments with glazed balconies:

Depressurising the apartment is essential to preheat ventilation air through glazed balconies.

Provided the external facades and other uncontrolled air inlets are air tight, ventilation rates can be controlled and limited by using wind pressure independent vents. Benefits of such vents are reduction of cross ventilation, good distribution of ventilation over opposite facades (less wind dependent) and maximisation of ventilation rates up to required levels.

The distribution of the vents over the facade is a means of controlling the percentage airflow through the glazed balcony, which can positively influence the use of solar gains in a glazed balcony.

It is possible to draw 30 – 50% of the fresh air through the balcony while keeping vents open on the opposite facade.

9.4 Glazed balconies and ventilation systems (CH)

Specification

Concept description

Glazed balconies have become an attractive renovation concept for apartment buildings.

Most of today's renovation concepts, for example new windows improve the air tightness of the building and reduce the air infiltration rate. This may lead to comfort problems that require correct manual window operation by the tenants or some sort of mechanical ventilation system. Especially in large apartment buildings and social housing, mechanical ventilation systems may be the most appropriate solution to prevent problems resulting from low air change rate and high humidity.

Glazed balconies in multi-family residential buildings provide the opportunity to use solar gains in the balcony for preheating ventilation air, which in turn increases the overall energy efficiency of the building.

Integrating glazed balconies into the mechanical ventilation systems was evaluated to optimise use of the solar gains of the glazed space. The most interesting concepts were:

- Glazed balcony design integrated with the central air exhaust system (A)
- Glazed balcony operates as a solar air collector combined with mechanical ventilation system with heat recovery (B).
- Glazed balcony design integrated with the central air exhaust system and a heat pump for domestic hot water or heating (C)

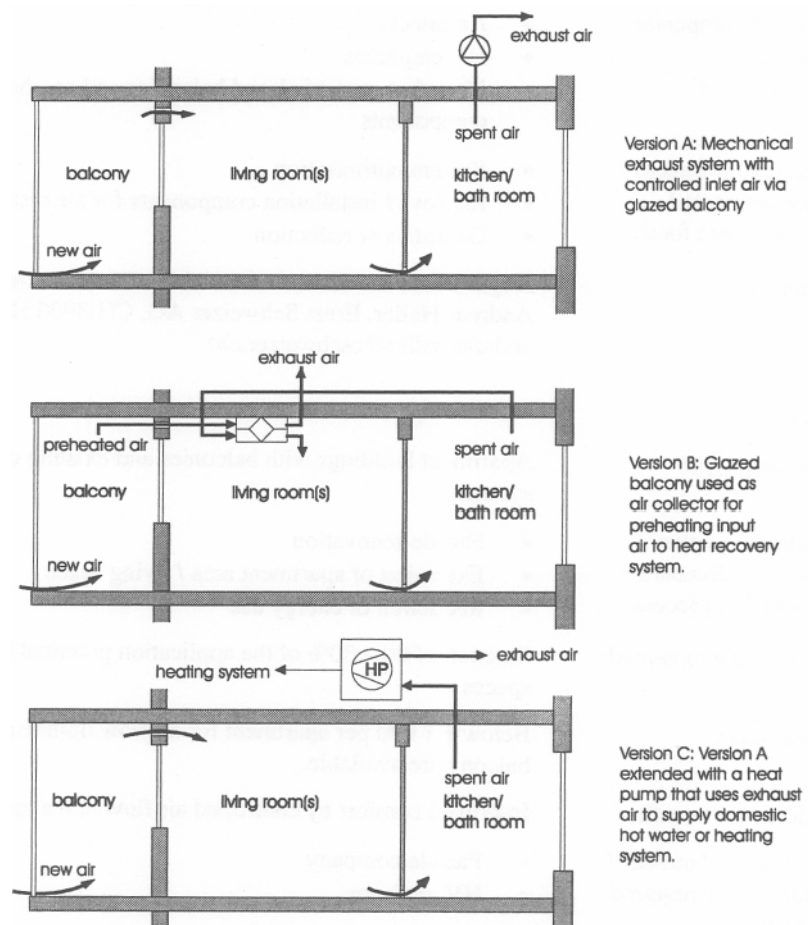

Figure 1: Principles of the different ventilation concepts.

Specific energy savings/energy gain	Reduction of space heating demand of 20 to 35 kWh per m ² heated floor area per heating season.
Innovative aspects for renovation	Improved use of solar energy gains by combination of existing systems.
Critical aspects	<ul style="list-style-type: none"> • Reduces air temperature in glazed space. • Possible air quality problems in the apartment (e.g. if the glazed space is used as a smoking area). • Depending on the floor plan, air preheated in the glazed balcony may not circulate through all rooms in an apartment. • Project specific problems may arise concerning installation space for air ducts, ventilation systems, etc. • Controlled air tightness of the renovated space.
References	R. Ruch, Balkonverglasung and kontrollierte Wohnungsluftung, Dr. Eicher + Pauli AG, for Swiss Federal Department of Energy, 1998.

Development

Development status	<ul style="list-style-type: none"> • Qualified concept and system models for version A, B and C • Existing demonstration project for version C that is monitored during 1999
Involved Systems/Components	<ul style="list-style-type: none"> • Components for glazed space/balcony • Mechanical ventilation systems, heat recovery systems and heat pumps • Installation components (e.g. air valves, etc.)
Type of companies involved in development	<ul style="list-style-type: none"> • Architects • HV engineers • Manufacturers of glazed balconies and mechanical ventilation systems and components
Required technical improvements / development focus	<ul style="list-style-type: none"> • System optimisation • Improved installation components for air systems • Overall cost reduction
Contact	Roger Ruch, Dr. Eicher + Pauli AG, CH-4410 Liestal (Fax. +41 61 923 00 25) Andreas Haller, Ernst Schweizer AG, CH-8908 Hedingen (e-mail: andreas.haller@eschweizer.ch)

Market

Building type	Apartment buildings with balconies and existing or new mechanical ventilation systems
Main renovation reasons / Standard renovation process	<ul style="list-style-type: none"> • Facade renovation • Extension of apartment area / living space • Reduction of energy use
Application potential	Fraction of 20 - 30% of the application potential for glazed balconies / glazed spaces
Cost target	Below €1 000 per apartment for air flow optimisation if ventilation system and balcony are available.
Additional benefits	Improved comfort by controlled air flow in the apartment
Contractor / builder / additionally required experts	<ul style="list-style-type: none"> • Facade company • HV engineer
Application examples	Project "Synergie", Wettingen, Switzerland (similar to version C); demonstration project of the Swiss Energy 2000 initiative

Modelling

Model description
 variant evaluation

The energy demand of the different variants was evaluated using a simplified building model for static energy balance calculations:

Building model characteristics:

Components	U-value, g-value	Area
Building wall:	0.2 W/(m ² .K)	869 m ²
Windows:	1.6 W/(m ² .K)	144 m ²
Wall to balcony:	1.1 W/(m ² .K)	155 m ²
Windows room to balcony:	1.6 W/(m ² .K)	73 m ²
Balcony wall:	1.9 W/(m ² .K)	53 m ²
Balcony glazing	1.6 W/(m ² .K) g*(shading factor) = 0.275	208 m ²
Characteristics of air system		
Air volume building:		2275 m ³
Air change rate building:		0.3 h ⁻¹
Air volume balcony:		258 m ³
Air change rate balcony:		0.3 h ⁻¹ (during heating season)
Efficiency heat recovery system:		0.6
Coefficient of performance of heat pump:		4

Parameters for variant evaluation

No other parameters than the ventilation system were changed.

Evaluation Criteria

- Reduction of heat energy demand
- Economic aspects

Evaluation Tool(s)

Proprietary tool based on static energy balance calculation

Model description for detail evaluation

A detailed evaluation for version A was conducted because this version has a good cost/performance ratio with low investment cost (see evaluation results). A simplified apartment model from the central part of the building was used. Room 2 is facing north, the balcony is facing south.

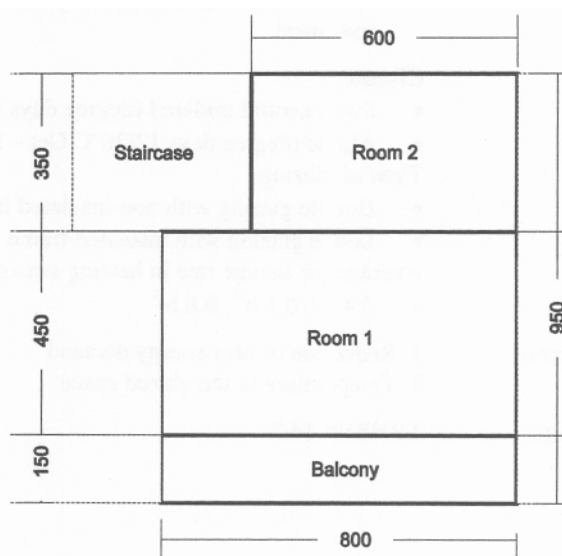

Figure 2: Floor plan of the detail evaluation model.

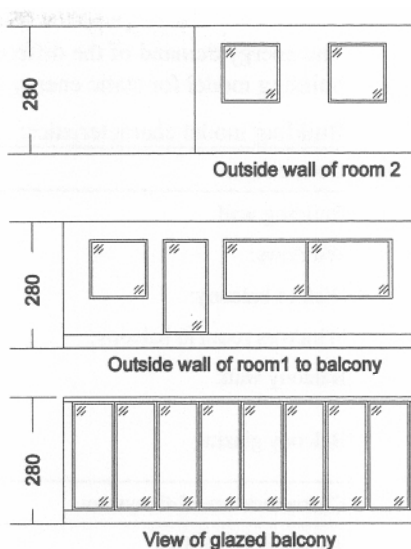

Figure 3: View of the relevant facade parts of the model for detail evaluation.

Component	U-value (W/m ² .K)	g-value	shading factor
Outside wall before renovation	0.99		
Outside wall after renovation	0.21		
Wall between room 1 and balcony	1.28		
Wall between rooms and staircase	2.19		
Balcony glazing 1: double glazing and not insulated metal frame	2.80	0.76	0.85
Balcony glazing: low-e glazing and insulated metal frame	1.30	0.59	0.85

- Ventilation concept: glazed balcony with exhaust air system (version A)
- Ceiling, floor and side walls to adjacent apartments are assumed to be adiabatic
- Air temperature in the staircase is set constant to 12°C during heating season
- Air flow rate in glazed balcony equals 50% of air change volume of the apartment

Parameters

Climate:

- Swiss central midland (degree days 12/20°C Oct - May: 3 234 Kd)
- Alpine (degree days 12/20°C Oct – May: 4 992 Kd)

Type of glazing:

- Double glazing with non-insulated frame
- Low-e glazing with insulated frame

Average air change rate in heating season

- 0.4 h⁻¹, 0.6 h⁻¹, 0.8 h⁻¹

Evaluation Criteria

1. Reduction of heat energy demand
2. Temperature in the glazed space

Evaluation Tool(s)

TRNSYS 14.2

Evaluation Results

Reduction of heat energy demand

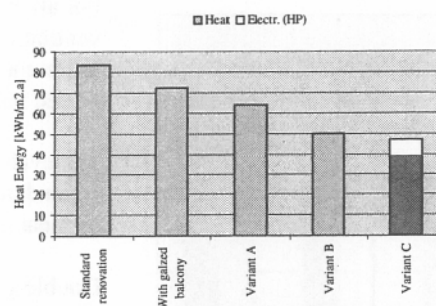

Figure 4: Heat energy demand before renovation was 200 kW per m² of heated floor area per heating season.

Ventilation version

The evaluation resulted in an additional heat energy demand reduction when the inlet air for a new or existing exhaust ventilation system comes through via the glazed balcony (version A). Versions B and C are almost equivalent in heat energy demand reduction. (Electricity for the heat pump counts twice; white part of bar for version C)

Cost evaluation
 (for a building similar to the model description)

		Version A	Version B	Version C
Energy demand reduction	kWh/(m ² .a)	8	18	34
Annual savings	kWh/a	34 000	74 000	140000
Additional el. energy				22'000
Cost per building unit	□			
Ventilation system		4 000	15 925	18 400
Electrical installation			750	1 375
Plumbing / heating system		1 875	325	3 450
Master-builder		325	5 000	5 000
Various		325	3 300	4 550
Consulting			5 000	6 875
Total per building unit		6 525	30 300	39 650
Total investment (8 units)		52 200	242 400	317 200
Capital costs		4 725	21 825	28 575
Electricity cost				2 500
Maintenance cost				
Total annual cost		4 725	21 825	31 075
Energy related part		80%	50%	50%
Energy related annual cost		3 780	10 912	15 550
Equivalent heat cost	□/kWh	0.110	0.147	0.110

Interest rate: 5% / life time: 15 years / electricity cost: □ 0.093

Reduction of heat energy demand

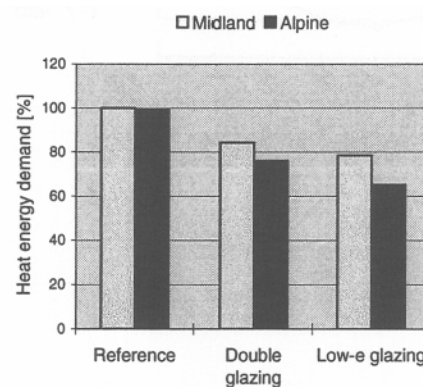

Figure 5: Heat energy reduction in function of climate (reference refers to double-glazing and no air preheating).

Climate and type of glazing

The high radiation levels in the alpine climate compensate for the lower ambient temperatures.

The benefit from using preheated air from the balcony increases for locations with high radiation.

A well-insulated balcony is also more beneficial in cold climates.

(Air change rate: 0.6 per hour)

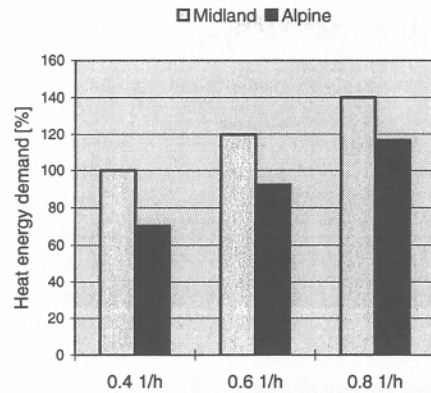

Figure 6: Heat energy demand dependent on air change rate of the apartment.

Comfort / air temperatures in glazed balcony

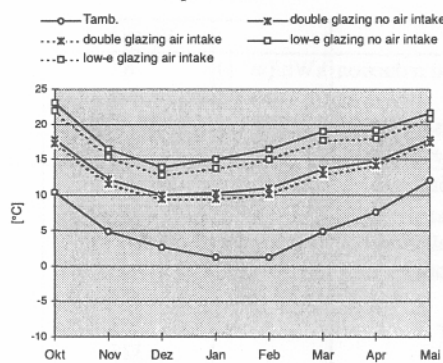

Figure 7: Monthly mean balcony temperatures for Swiss midland climate.

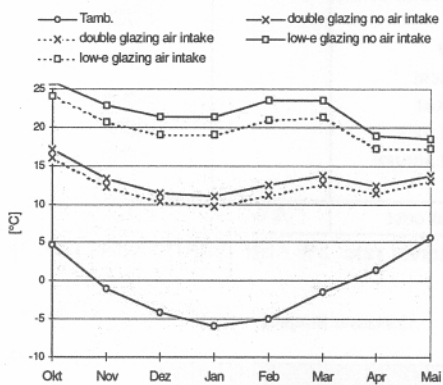

Figure 8: Monthly mean balcony temperatures for Swiss alpine climate.

Air change rate of the apartment

For all examples 50% of the ventilation air entering the apartment is assumed to enter through the glazed balcony.

The evaluation shows a linear dependence on the air change rate for the heat energy demand.

Double-glazing was assumed for the Swiss midland climate and low-e glazing with insulated aluminium frames was assumed for the alpine climate.

Climate and type of glazing

The temperature in the balcony with a low-e glazing and insulated frame system is on average 5°K higher than in the balcony constructed with double glazing windows.

The air intake through the balcony at a rate of 50% of the apartment's air change rate lowers the balcony temperature by an average of 1.5°K.

For the sunny alpine climate the monthly average balcony temperatures during the heating season are only slightly below 20°C if high quality glazing and frames are used.

The air intake from the balcony to the apartment lowers the air temperatures in the balcony between 2°K and 5°K.

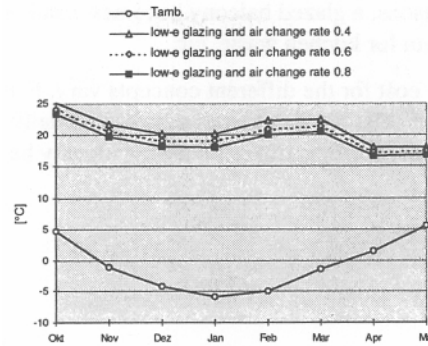

Figure 9: Balcony temperature depending on air change rate.

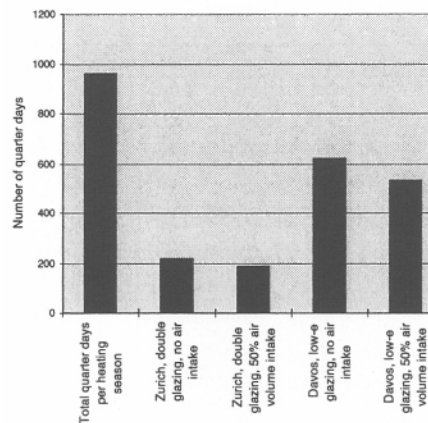

Figure 10: Number of quarter days with air temperatures above 18°C during the heating season.

Air change rate

The influence of the apartment air change rate on the average balcony temperature is moderate: about 0.5°K per 0.1 air change per hour.

However, this is also dependent on the air intake volume from the balcony (50% of the air change volume is assumed to come via balcony for the evaluation).

The air temperature reduction in the glazed balcony reduces the availability of the glazed balcony as an extended living space.

In a double glazed balcony in the Swiss midland climate the number of quarter days (6-hour periods) with average air temperatures above 18°C is reduced from 220 to 190 quarter days during the heating season.

In the alpine climate, the number of quarter days with temperatures above 18°C in a low-e glazed balcony is reduced from 620 to 530 quarter days.

Conclusions

The combination of glazed balconies with mechanical ventilation systems is an attractive concept to improve the solar energy gains from the glazed space. For apartments with central air exhaust systems, the controlled air intake from the balcony may reduce heat energy demand in the order of 20% compared with the situation of direct air intake from ambient.

Concepts with heat recovery systems reduce the heat energy demand by up to 50% compared with regular exhaust systems with ambient air intake. However, systems that preheat the fresh air by heat recovery do - to a certain extent - conflict with the solar preheating of the air in the balcony.

The potential of the heat demand reduction depends on climate, the balcony design, (orientation, area of glazing) and the characteristics of the glazing system for the balcony.

In renovation cases, difficulties may arise in controlling the airflow and supplying air from the balcony to the complete apartment. However, even with an air intake rate of 50% of the apartment's air change rate, substantial usage of the solar gains from the glazed balcony may be achieved.

All concepts result in a reduction of the balcony air temperature between 1.5°K to 5°K. This reduces the period during the heating season when the glazed balcony may be used as an additional living space from 30 to 100 quarter days (mornings or afternoons) per year.

For comfort reasons, a glazed balcony becomes unsuitable as a smoking zone and as a storage room for kitchen waste, etc.

The investment cost for the different concepts vary. For limited renovation budgets, the controlled air inlet for the exhaust system is usually the most appropriate concept, especially if the apartment building already has an installed central air exhaust system.

9.5 Static shading for TI wall heating systems (D)

Specification

Concept description

In 1996, the German company Sto introduced a composite transparent insulation (TI) system into the market. The system integrates the function of a solar mass wall with TI into the construction of a glued insulation and finish system for buildings. Its design is especially suitable for building renovation. A project of this type was part of Subtask C work and evaluated within Subtask E („Villa Tannheim“, Freiburg, Germany). The composite transparent insulation system is used till now without active shading device such as a venetian blind. The main reasons are architectural consistency with a conventional, non-transparent composite insulation and finish system and, of course, cost reduction. Therefore, its application to building facade retrofits was limited to less than 30% of the total facade area to minimise the summer solar gains. The system must be dimensioned so that overheating in summer is avoided.

Until recently, passive shading for solar gain control was not considered as an integral part of the composite TI system. An advanced concept may therefore consider **passive shading by architectural elements** on the facade. Such an approach decreases the summer solar gain but must be engineered so that at the same time they do not decrease wanted winter gains too much. Engineered shading elements on walls having a south orientation lead to improved summer comfort. Shading elements may exist (e.g. balcony plates) or may be added to the facade during the renovation. Properly sized overhangs on south orientations can be engineered to eliminate summer solar gains yet allow the desired amount of winter gains.

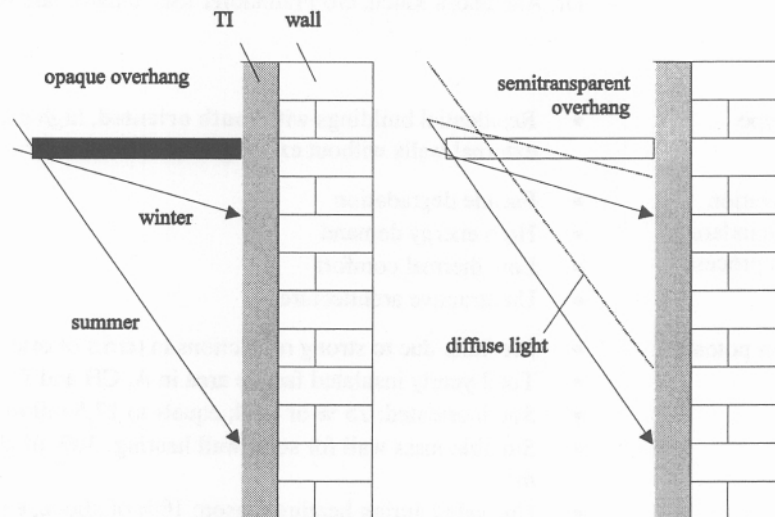

Figure 1: Principle of static shading by an overhang.

Left: opaque overhang

Right: selective overhang

Specific energy savings/energy gain

- Reduction of the transmission losses of an external wall plus solar gains by wall heating: 30 - 50 kWh/(m².a) minus reduction by winter shading effect of the overhang.
- The objective of this advanced concept study is to determine reduction of winter solar gains and improvements for the summer comfort.

Innovative aspects for renovation

- Application on buildings with existing overhangs or wing wall type shading elements
- Improved summer comfort

Critical aspects	Reduction of the winter solar gains, especially if existing architectural elements are used as passive shading devices
References	<ul style="list-style-type: none"> • IEA SHCP Task 20 brochure: Transparent Insulation in Building Renovation • DBU report (DE): SchluBbericht Villa Tannheim, Fraunhofer ISE, TOS-1-9709-VK-05, 1997 • Diploma work at Fraunhofer ISE (DE): Einfluss statischer Verschattung auf den jahreszeitabhängigen Energiegewinn eines transparenten Wärmedämmverbund systems, Christoph Gehrig, 1998
<i>Development</i>	
Development status	<ul style="list-style-type: none"> • Quantified concept. • Simulations performed at Fraunhofer ISE in 1998
Involved Systems / Components	Composite TI system (Sto AG)
Required technical improvements / development focus	Design guidelines describing the effect of static shading elements (opaque or semitransparent) on the solar mass wall system performance
Type of companies involved in development	TI system manufacturer (Sto AG)
Contact	Dr. Alexandra Raicu, c/o Fraunhofer ISE, e-mail: raicu@ise.fhg.de
<i>Market</i>	
Building type	<ul style="list-style-type: none"> • Residential buildings with south oriented, high density ($> 1200 \text{ kg/m}^3$) external walls without existing insulation
Main renovation reasons / Standard renovation process	<ul style="list-style-type: none"> • Facade degradation • High energy demand • Low thermal comfort • Unattractive architecture
Application potential	<ul style="list-style-type: none"> • Medium, due to strong restrictions in terms of orientation and wall material • Total yearly insulated facade area in A, CH and D: 70 million m^2 per year • South oriented: 25 % of total; equals to 17.5 million m^2 • Suitable mass wall for solar wall heating: 30% of above; equals 5.25 million m^2. • Unshaded during heating season: 10% of above, equals to 525 000 m^2 facade • Walls with existing overhangs: 10% of above, equals to 52 500 m^2 facade • Maximum TI coverage with: 40% of above, equals to -20 000 m^2 TI compound system
Cost target	No additional cost for situations with existing overhangs
Additional benefits	Increased summer comfort
Contractor/builder / additionally required experts	<ul style="list-style-type: none"> • Facade company installing the composite TI system • Manufacturer for static shading elements (e.g. metal construction companies) • Architect

- Application examples
- An exemplary demonstration building will be built as follow-up of the simulation activities if energy and comfort milestones are achieved in winter and summer
 - Further application will be based on the demonstration project results

Modelling

- Model description
- Residential building in heating dominated central European climate, no cooling considered
 - Single zone building simulation model using TRNSYS
 - Location Freiburg (Germany, climate data TRY 7), wall orientation south
 - Overhang effect on incident radiation on the wall calculated with standard TRNSYS types

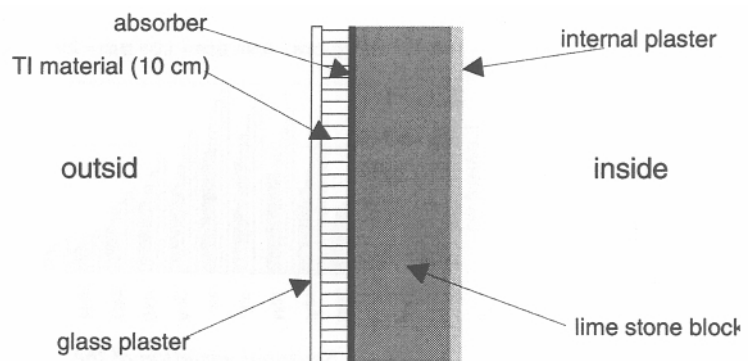

U-value of the opaque wall: $U_W = 1.26 \text{ W/m}^2\text{K}$
 U-value of the TI-system: $U_{TI} = 0.94 \text{ W/m}^2\text{K}$
 Total energy transmittance of the TI system (diffuse): $g_{diff} = 45 \%$

Figure2: Set of parameters for simulation of the overhang

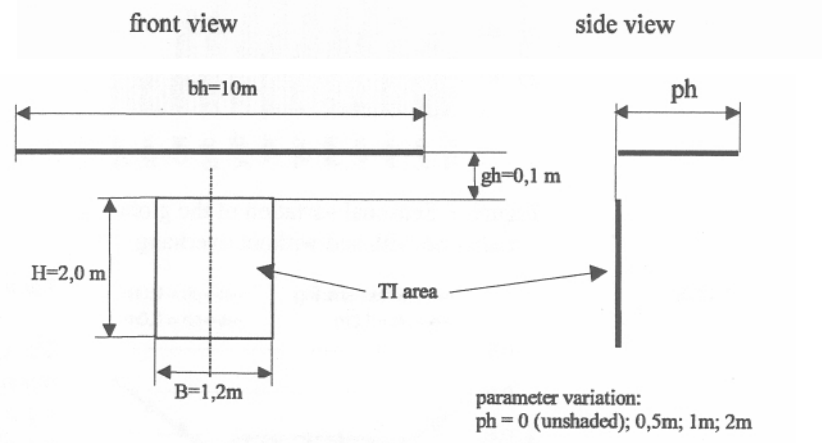

Figure 3: Sketch of the facade model and the physical properties assumed in the simulation analysis

- Parameters Dimension of the overhang ph
- Evaluation Criteria
1. seasonal decrease of incident direct, diffuse and global radiation
 2. seasonal change of the total energy transmittance of the TI system
 3. seasonal reduction of solar gains as function time
- Evaluation Tool(s) TRNSYS 14.2

Evaluation Results

Results Criteria 1

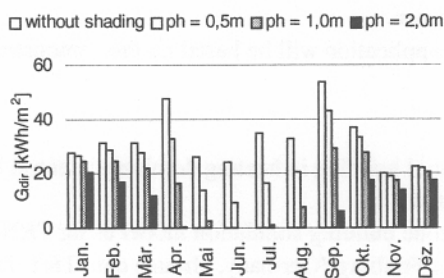

Figure 4: Seasonal variation of the direct radiation with and without overhang.

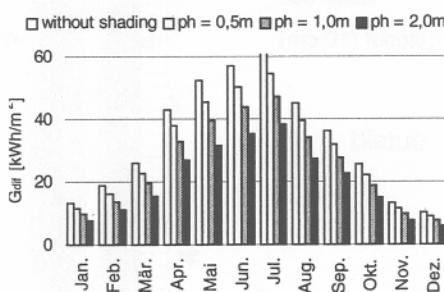

Figure 5: Seasonal variation of the diffuse radiation with and without overhang.

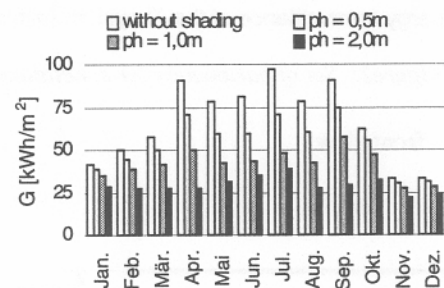

Figure 6: Seasonal variation of the global radiation with and without overhang.

Results Criteria 2

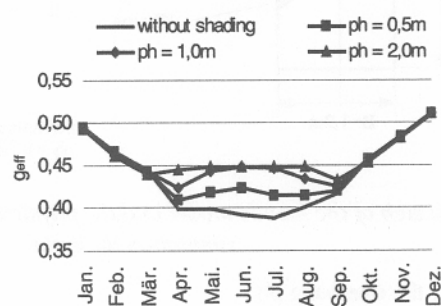

Figure 7: Seasonal variation of the monthly average solar energy transmittance.

Decrease in radiation

An overhang on a south oriented wall operates as seasonal filter for direct solar radiation. If the overhang is as wide as the absorber is high (ph= 2 m), direct radiation between April and August is decreased nearly 100%. The decrease in December is then about 23%. An overhang whose length is 50% of the absorber height (ph=1 m) is a compromise between summer direct gain control (comfort) and winter direct gain reduction (energy balance).

Diffuse radiation - assuming an isotropic sky model - is reduced without seasonal variation. Larger overhangs will have a greater effect on reducing solar gains. The large overhang (ph=2m) reduces the diffuse radiation by 40%, directly proportional to the reduction of the view factor of the sky. Combining data for direct and diffuse radiation smoothes the seasonal control effect of an overhang. The large overhang (ph=2m) reduces the radiation in July by 61%, in December by 30%.

Total energy transmission

The effective solar energy transmittance g_{eff} is the ratio of the incident solar radiation transmitted through the TI system. Due to the seasonal variation of the sun's position and the effect of the overhang, g_{eff} varies with the season. According to the diagram the seasonal change of g_{eff} is partly a counter effect to the seasonal effect of the overhang.

Results Criteria 3

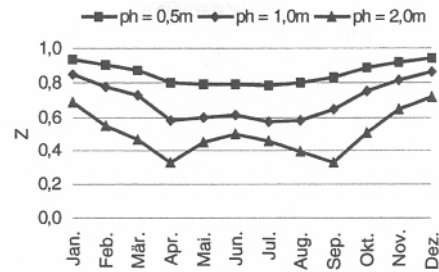

Solar shading factor as function of time

Combining the effects of radiation control by an overhang and seasonal variation of the solar energy transmittance in a shading factor results in „Z,, which describes the total effect of the investigated system design. Without an overhang, Z is constant and equal to 1.

Figure 8: Seasonal variation of the monthly average solar shading factor.

Conclusions

Simulations show that passive solar gain control with seasonal variation is possible using an overhang. Unless the overhangs are properly sized, minimising the summer solar gains may also decrease wanted solar gains in the winter and result in increased heating loads. Therefore, the approach is a compromise to controlling both summer and winter gains.

Accepting 15% reduction of solar gains in the central winter months allows a reduction of solar gains in the order of 40% during summer (ph=1m). This describes a "typical" example for a 2 m high TI wall under a 1 m wide balcony. Comparing two cases with equal summer comfort (equal summer solar gains, June to August) allow for an increase of the active TI area by 40%. The winter solar gains over the whole heating season (September to May) will still be approximately identical as the specific gains per m² are reduced.

The main advantage is the change in the distribution of the gains over the heating season. More gains are available in the central winter months (40 % more area overrides the effect of 15% less gains) and less gains are available in spring and autumn (ref. results of criteria 3). Only project-specific simulations can determine if this shift benefits the building energy balance.

A parametric study for orientations other than south clearly underlines the strong limitation to south oriented walls.

In the cases of locations of higher latitude the seasonal control function is reduced due to the lower incident angle of the radiation.

Cost calculations were not part of the investigation. As the TI compound system is not designed to be used with active shading devices like blinds, the passive solar gain control can not be compared to an active control on an economical basis. Passive solar gain control allows an increase in the TI area without decreasing the summer comfort.

In the renovation case, the investigation provided the opportunity to compare the effect on building energy consumption resulting from a TI system mounted on walls with existing overhangs (e.g. balconies) compared to situations without shading.

9.6 Ventilated solar wall heating with TI (CH, D)

Specification

Concept description

Large area solar wall heating systems with transparent insulation material (TIM) need a solar gain control strategy to reduce comfort problems occurring outside of the heating season. Most of the applications implemented so far and most of the systems available use some kind of shading devices for this purpose. The advantages are the simplicity of the concept and the variety of the commercially available products (venetian blind etc.). The drawbacks are high investments and high maintenance cost for variable shading systems and reduced solar energy gains for fixed shading systems.

A different approach to prevent overheating is to purge the excess heat by means of ventilation air - a basic concept introduced already by Trombe during the invention of the solar wall concept in 1977. There are prototype products of TI wall heating systems available on the market using this concept of solar gain control.

This concept requires an absorber separated from the mass wall, a ventilation channel, and variable openings on the top and the bottom of the solar wall or the wall elements (see following graph). Solar gain control may be realised by natural or mechanical ventilation.

This system also allows for further improvement of the solar concept by using the warm air in the building's HVAC system or using a fluid based heat exchanger as an absorber (thermal collector absorber). Natural ventilation may then serve as overheat protection of the system.

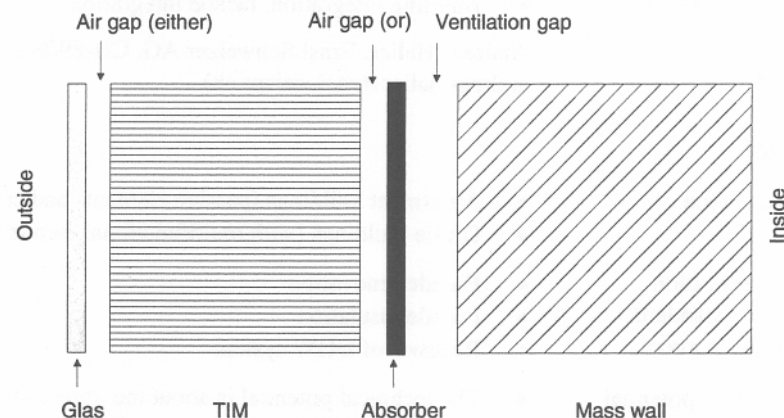

Figure 1: Principle section of the ventilated solar wall heating system.

Specific energy savings/energy gain

- Compensation of transmission losses of an external wall plus solar gains between 50 - 100 kWh/(m².a) (depending on mass wall material and climate).
- For combination with solar collector absorber for domestic hot water (DHW) systems additional gains of 200 - 350 kWh/(m².a) are expected.

Innovative aspects for renovation

- Improved integration in existing facades without changing the appearance for solar gain control (e.g. external roller blinds).
- Prefabricated wall elements developed for renovation applications and for use in combination with opaque insulation systems.
- Opportunity for multi-functional use of (limited) available facade area.

Critical aspects

- Optimal dimensions of TI material and air gaps
- Radiation and absorption properties of absorber
- Mechanical parts for closing and opening the ventilation gap
- Control of the ventilation openings for multi-functional systems

- References
- P. Achard, R. Gicquel, European passive solar handbook, preliminary edition, 1986.
 - G. Liersch, Untersuchungen des Energietransportes in einer konvektiv hinterlufteten transparenten Warmedammfassade, 1993.
 - D.Schwarz, Two residential buildings with TI in Domat/Ems, Switzerland, realised as demonstration projects in 1996.

Development

- Development status
- Passive solar version with natural air ventilation for solar gain control: Qualified concept
- Prototype design of facade element with various absorber types under evaluation
 - Cost effective solutions for operation of the ventilation openings are pending.
- Multifunctional system with active thermal collector: Unqualified concept
- Involved Systems / Components
- Glazed TI facade element
 - Automated air flaps and control
 - Solar thermal collector absorber
- Type of companies involved in development
- Metal and facade construction company
 - Consultant for fluid-dynamic calculations and facade testing
 - Coating company for selective surfaces / absorbers
 - Producer of air flaps and control systems
- Required technical improvements / development focus
- Optimised absorber for glazed TI facade element
 - Air channel and openings for natural ventilation
 - Building integration, facade integration
- Contact
- Andreas Haller, Ernst Schweizer AG, CH-8908-Hedingen (e-mail: andreas.haller@eschweizer.ch)

Market

- Building type
- Apartment buildings (passive elements and combined DHW systems)
 - Office buildings (with multifunctional facade elements)
- Main renovation reasons / Standard renovation process
- Facade renovation
 - Facade insulation
 - Renewal of DHW system
- Application potential
- The technical potential is about the same as for other solar wall heating systems with TI (see Concept no. 7).
 - Market potential limited by the achieved cost performance: A first estimate indicates that the current market potential is equivalent to other glazed solar wall heating system with TI (1 000 – 3 000 m² per year in Germany, Austria, and Switzerland).
- Cost target
- Total cost must be less than €250 per facade element including gear and control.
- Additional benefits
- Improved winter comfort
- Contractor/builder / additionally required experts
- Facade company
 - Architect
 - HVAC planner and plumber (multi-functional elements, only)
- Application examples
- To be built as follow-up of the development activities if cost and functionality goals are achieved.

Prototype Design

Construction

Total energy gained depends on transmission of transparent layers and absorption and emittance coefficients.

Layers	Prototype version	
	High inertia absorber	Selective absorber
Transparent layers	<ul style="list-style-type: none"> • low iron glass 4 mm as cover • air gap 3 mm • capillary plate (PC) 100 mm 	<ul style="list-style-type: none"> • low iron glass 4 mm as cover • capillary plate (PC) 80 mm • air gap 23 mm
Absorber (measured values or producer information)	Fibre enforced concrete plate $\alpha = 0.72 (\pm 0.05)$ $\epsilon_{\text{front}} = 0.9 (\pm 0.05)$ $\epsilon_{\text{back}} = 0.9 (\pm 0.05)$	Selective coated (NiCr) stainless steel $\alpha = 0.94 - 0.96$ $\epsilon_{\text{front}} = 0.085 - 0.12$ $\epsilon_{\text{back}} = 0.42 (\pm 0.05)$

Prototypes base on existing thermally broken aluminium frame system for facade cladding and insulation system.

Design value for ventilation air gap between absorber and mass wall: 60 mm for channel height of 2.5 to 3.0 m.

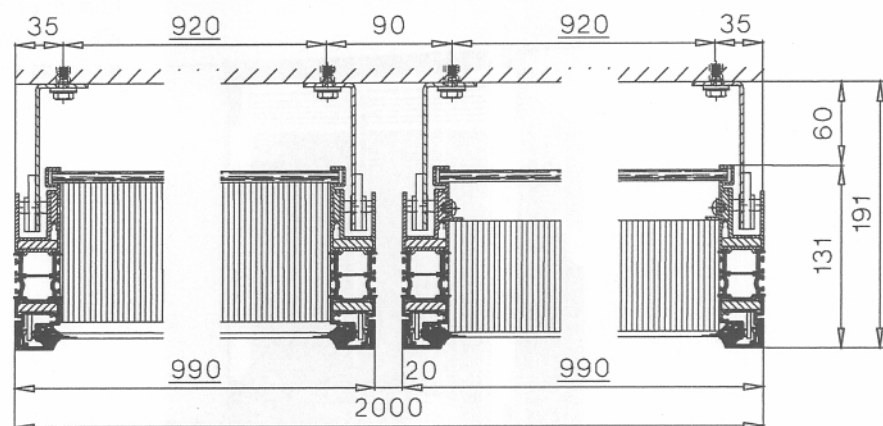

Figure 2: Horizontal section of the two prototype constructions: high inertia absorber on the left, selective surface absorber on the right.

Requirements for ventilation openings:

- Minimise pressure drop for natural convection air stream
- Minimise sensitivity to external air turbulence and wind pressure
- Full element width if possible
- Minimum height equals depth of ventilation channel
- Thermally insulated units (U -value $< 2.0 \text{ W/m}^2 \text{ K}$)
- Air tight in closed situation (equivalent to a window: $a < 0.8 \text{ m}^3/(\text{h.m.Pa}^\vee)$)
- Cost target: total cost must be less than E 250 per facade element including gear and control

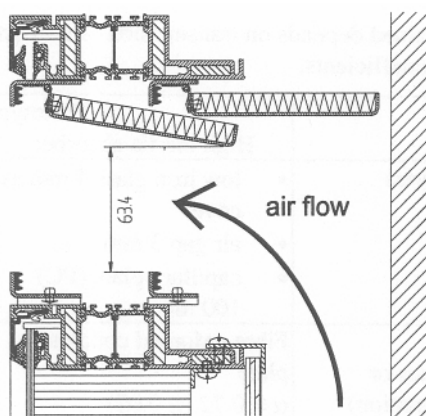

Figure 3: Vertical section of upper ventilation opening with double flaps (no gear included).

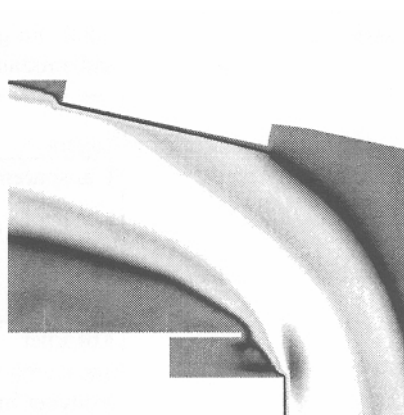

Figure 4: Simulated air flow pattern of upper ventilation opening: laminar air flow (light grey) with turbulent zones (dark shades) and static areas (dark grey)

Installation

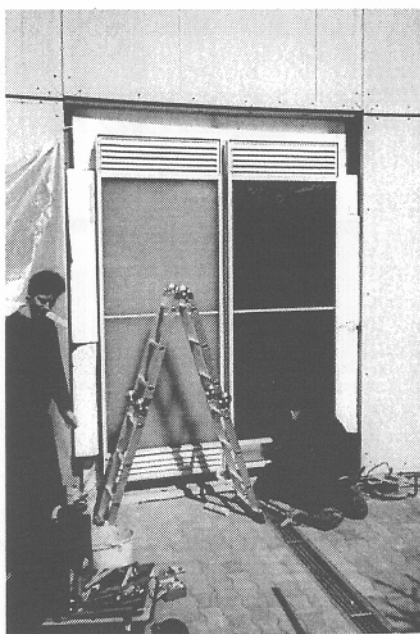

Figure 5: Prototypes during installation at the Fraunhofer ISE facade test site.

The ventilation openings at top and bottom of the elements are oversized to allow for experimental variation of the air inlets and outlets.

Prototype Evaluation

Result solar wall heating

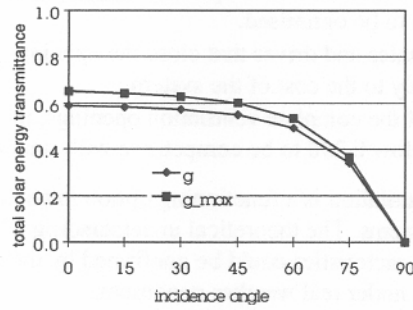

Figure 6: Transmission characteristics high inertia absorber.

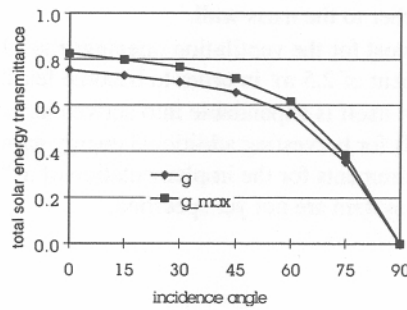

Figure 7: Transmission characteristics selective absorber.

Result solar gain control

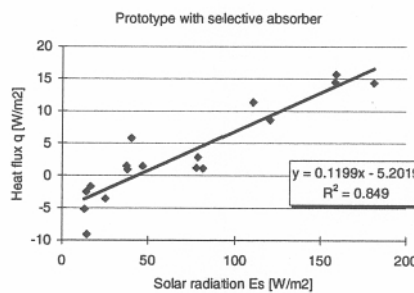

Figure 8: Evaluation of the energy transmission in ventilated mode.

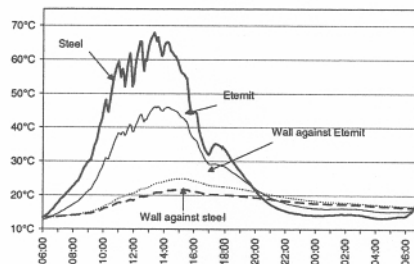

Figure 9: Temperature courses for a bright summer day.

Key characteristics

U-value and total energy transmission of prototype with high inertia absorber

- U-value = 0.78 W/(m².K) including frame
- g_max (centre of glass) = 0.65

Key characteristics

U-value and total energy transmission of prototype with metal absorber

- U-value = 0.72 W/m²K including frame
- g_max (centre of glass) = 0.82

Energy transmission in ventilated mode

For the selective metal sheet absorber with backside emittance of about 40%, the total energy transmission of the solar wall is below 12% in the ventilated mode. This is a sufficiently low factor to prevent overheating of larger solar wall heating areas during summer in central Europe.

Material parameter influence

A lower absorption coefficient and increased inertia result in Eternit absorber peak temperatures that are about 30°C lower than that for the selective steel absorber. Despite the high temperatures of the absorber, the mass wall coupled to the steel absorber is cooler than for the Eternit absorber in the ventilated state because of the lower backside emittance of the steel absorber.

- Cost estimation
- The cost increase for the basic facade element with a ventilation channel is low because only the mounting structure needs to be adapted.
 - The cost for the ventilation openings for the prototypes is prohibitively high. This needs to be optimised.
 - The mechanics and drives that close the openings in wall heating mode add considerably to the cost of the system.
 - The cost of the complete ventilation openings, including mechanics and drives must be below €250 to be competitive with standard external shading devices.
- Conclusions
- Natural ventilation is a functioning option to control solar gains for solar wall heating systems. The theoretical understanding of the influence of the absorber surface characteristics could be confirmed by the measurements of the two prototypes under real weather conditions.
 - At the time of reporting, the measured energy gains for solar wall system during the heating season without natural ventilation were not available. However, the performance is expected to be less than 10% below the performance of a solar wall where the absorber is directly coupled to the mass wall. Reduction is expected to be less than 10% compared to direct coupling of the absorber to the mass wall.
 - Additional cost for the ventilation openings must be less than €250 for a facade element of 2.5 m² in order to become feasible.
 - The concept itself is expandable into active thermal collector systems (air or water based) for harvesting additional energy gains in summer. However, the design requirements for the implementation of a "hybrid" (combined passive and active) system are not yet specified.

9.7 Low cost TI wall heating system (CH)

Specification

Concept description

Transparently insulated (TI) massive walls form an efficient and attractive solar renovation concept by reducing energy requirements for space heating and improving comfort situation because of increased wall surface temperatures.

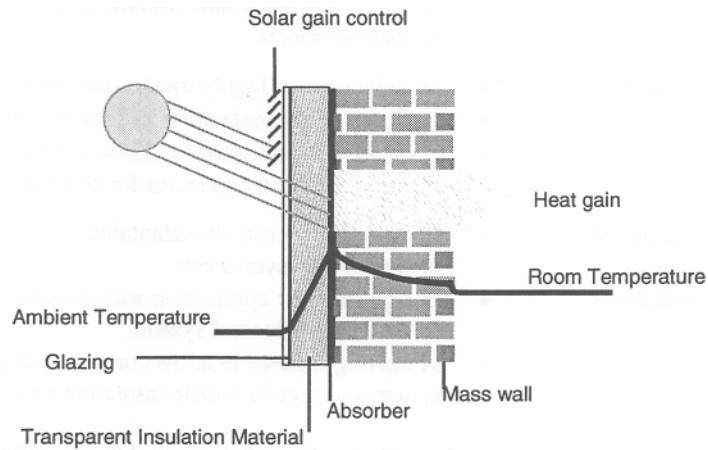

Figure 1: General principle of the solar wall heating system with TI.

The high investment cost of the high-performance glazed TI systems is a major hindrance for a more widespread application of this concept. Experiences demonstrate a few of the main reasons the high system cost:

- Expensive support structure for the currently used honeycomb or capillary TI materials.
- High planning and design costs, especially for renovations
- Most TI wall heating systems require additional craftsmen for mounting
- Need for solar gain control

In order to reduce total system costs a novel TI facade system will be investigated using mechanically sufficient stable and inherently weather protected TI material (multi-layer Macrolon® sheets).

The facade system needs to adapt to the usual dimension tolerances of on-site constructed building. A reduction in energy gains may be tolerated if investment cost can be sufficiently reduced.

Solar gain control may be avoided by covering only a part of the available facade area.

Specific energy savings/energy gain

Compensation of the transmission losses and additional gains of 40 - 80 kWh per m² of TI wall per heating season.

Innovative aspects for renovation

- Reduction of material (less framing, no glass panes)
- Application by traditional facade workers together with standard facade insulation
- Adaptation to building tolerances on the building site
- Reduced planning cost
- Use of existing distribution channels

Critical aspects

- Cost effective framing system
- Acceptance of the system by the facade insulation companies
- Acceptance of (plastic) facade material by architects and customers
- Conform to fire protection regulations because of the (uncovered) TI material

References

- IEA SHCP Task 20 brochure: Transparent Insulation in Building Renovation
- IEA SHCP Task 20 - Subtask E: Evaluation of Demonstration Projects

Development

Development status	<ul style="list-style-type: none">• Qualified concept• Prototype design and evaluated prototype of TI component• No development for site-adaptable facade system pending
Involved Systems / Components	<ul style="list-style-type: none">• TI elements from two or more stacked layers of multi-layer Macrolon® sheets• Low cost, site-adaptable framing and facade mounting system for stacked multi-layer sheets
Type of companies involved	<ul style="list-style-type: none">• Manufacturer of highly transparent multi-layer sheets• Designer and manufacturer of facade systems• Contractor experienced in plastic sheet handling (e.g. greenhouse builder)• Manufacturer and contractor for standard facade insulation systems
Required technical improvements / development focus	<ul style="list-style-type: none">• Design of low-cost, site-adaptable framing and facade mounting system for stacked multi-layer sheets• Design rules for application without solar gain control or adaptation of low-cost solar gain control system• Marketing concept to allow commissioning of the improved solar wall heating system and regular facade insulation by a single contractor
Contact	Andreas Haller, Ernst Schweizer AG, CH-8908-Hedingen, e-mail: andreas.haller @ eschweizer.ch

Market

Building type	<ul style="list-style-type: none">• Single family home• Apartment building• Industrial hall, storehouse• Public service building
Main renovation reasons / Standard renovation process	<ul style="list-style-type: none">• Facade renovation• Facade insulation
Application potential	Market potential study for Austria, Germany and Switzerland: 70 million m ² building facade insulation per year. <ul style="list-style-type: none">• South oriented: 25 % of total; equals to 17.5 million m²• Suitable mass wall for solar wall heating: 30% of above; equals to 5.25 million m²• Unshaded area: 10% of above; equals to 525 000 m² per year
Cost target	Total cost must be less than E 280 per m ² installed solar wall heating (without active solar gain control).
Additional benefits	Increased comfort for solar wall heating parts of the building envelope (e.g., specially suited for bathrooms)
Contractor / builder / additionally required experts	<ul style="list-style-type: none">• Installation by regular facade insulation worker• No special experts required on site
Application examples	None up to reporting date

Modelling

Model description

Based on measured energy transmissions and U-values of multi-layer Macrolon® sheets, the energy gains of potential TI wall heating systems were evaluated for the following building model:

Heated floor space	170 m ²		
Footprint	100 m ²		
Volume	554 m ³	without attic	
Surface	420 m ²		
		U-value window	g
Window South	13.75 m ²	1.4 W/(m ² .K)	0.62
Window East	11.00 m ²	1.4 W/(m ² .K)	0.62
Window West	11.00 m ²	1.4 W/(m ² .K)	0.62
Window North	8.25 m ²	1.4 W/(m ² .K)	0.62
Opaque facade	154.00 m ²	0.30 W/(m ² .K)	
Roof	100.00 m ²	0.21 W/(m ² .K)	
Basement	100.00 m ²	0.41 W/(m ² .K)	
Solar wall heating	22.00 m ²	See below	See below

Parameters

TI variants and reference	Thickness [mm]	U-value [W/m ² .K]	g _h
Opaque insulation	100	0.33	0.00
2 stacked PC sheets	64	1.00	0.41
3 stacked PC sheets	103	0.7	0.27
Capillaries	105	0.9	0.60

Evaluation Criteria

Energy gains per m² solar wall heating

- for varying orientations of the TI facade
- for TI variants

Reduction of heat energy demand per heated floor area

- for varying orientations of the TI facade
- for TI variants

Evaluation Tool(s)

Monthly energy balance method with a proprietary static evaluation tool from Fraunhofer-ISE, Freiburg, Germany

Evaluation Results

Energy aspects

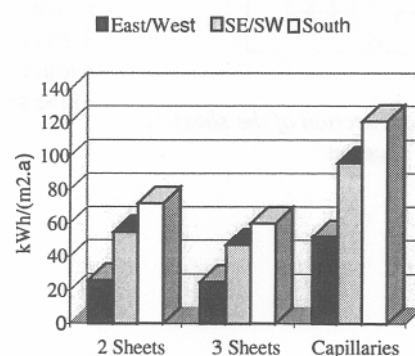

Figure 2: Energy gains per m² solar wall heating.

All variants of TI systems (for details see Parameters above) compensate the loss of the opaque reference system by approximately 30 kWh/(m².a).

In addition, all variants result in a net energy gain for orientations between East and West.

(These values are valid for the heating period from October to April in Freiburg, Germany)

Heat energy demand per m^2 heated floor space

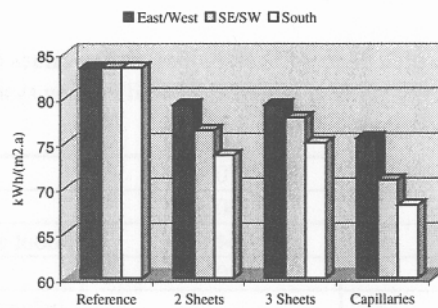

Figure 3: Heat energy demand per m^2 heated floor space.

Heat energy demand reduction is not as prominent (4% to 11%) because the solar wall heating area is only about 10% of the total facade area of the building model.

Conclusions

- The 2-sheet stack seems to be the optimal variant. The U-value of only one layer would not be sufficient ($1.7 \text{ W}/(\text{m}^2 \cdot \text{K})$). A stack of three sheets reduces the solar transmission too much.
- South orientation is the preferred application.

Prototype Design

Construction

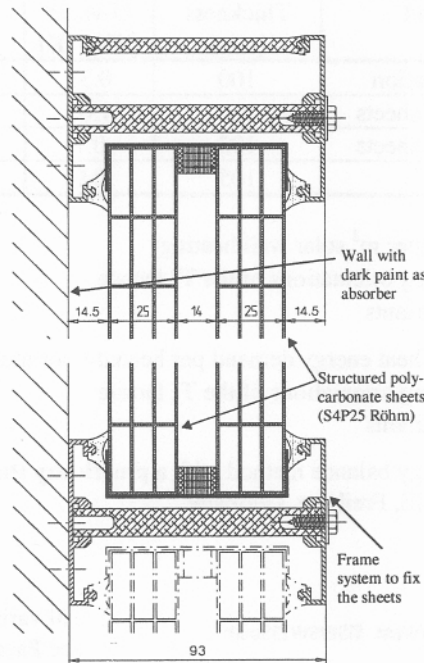

Figure 4: Vertical section of the sheet TI system.

A stack of two multi-layer sheets with a frame system is mounted in front of a dark coloured mass wall. The framing system must be sufficiently insulated by a thermal brake. The framing system must allow a joint to the opaque insulation system and allow for service of the multi-layer stacked sheets without destruction of the adjacent opaque insulation system.

The spacers in the stack create an additional insulating air layer. A glue tape on top and sides seal the stack. The stack must be sufficiently open to moisture transfer at the bottom.

The practical maximum height of a single module is between 2.60 and 3.20 m (one storey). The maximum width is given by the available width of the sheet (980 mm).

Installation



Figure 5: Installation of the prototype.

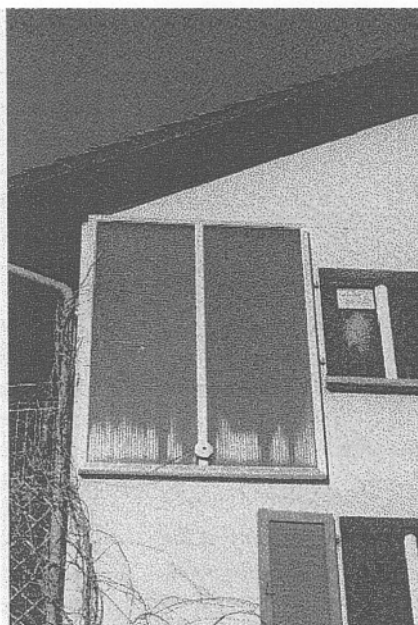

Figure 6: Test site of the prototype on a typical apartment building.

Mounting with prefabricated frames

A prototype of this solar wall system was installed on the south facade of a typical apartment building built in the early 1950s. The brick facade was painted black. Then the prefabricated frame for a double module was attached to the wall. The prefabricated stacked sheets were inserted into the base frame. A cover frame holds the sheets in place.

Aesthetics and moisture condensation

The aesthetics of the prototype installation may not be representative because there is no integration into the facade.

The condensation in the lower part can be eliminated by improved measures to avoid moisture accumulation in the cavities of the multi-layer sheets. (For the prototype the stack was sealed on all four sides. The bottom seal must be left out.)

Evaluation Results

Characteristic properties

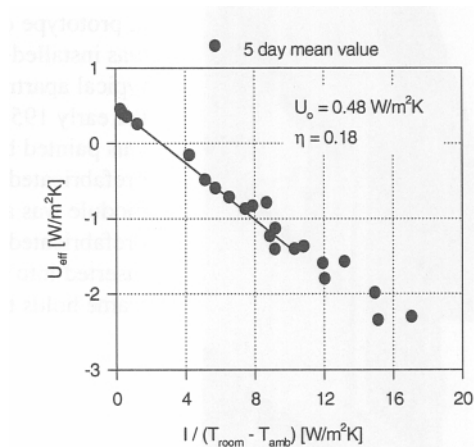

Figure 7: Regression plot of the mean values of measurement results allows the determination of the characteristic values of the system.

Comfort

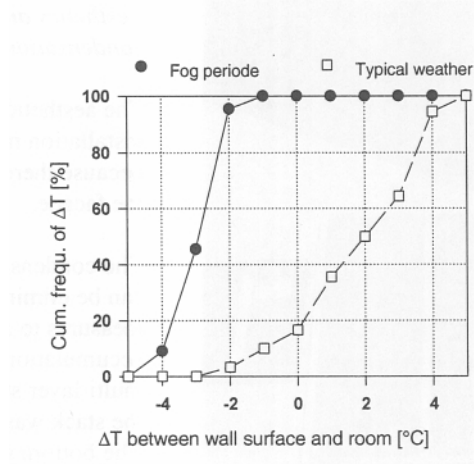

Figure 8: Cumulative frequency of the temperature difference between inner wall surface and room air for a wall with an equivalent U-value of 0.5 W/(m².K) and the solar wall prototype.

U-value and solar efficiency

The characteristic properties of the solar wall heating system with the staked multi-layer PC sheets were calculated from the measured data. They were integrated to 5-day mean values. Every dot represents the energy transmission versus the climatic factor for a 5-day period. The regression curve results in a U-value of 0.48 W/m²K at no solar incidence and a solar efficiency of $\eta = 18\%$ (gradient of the 1st order regression).

Wall surface temperature

During prototype evaluation there was an extraordinarily long period (4 weeks) with very low radiation levels due to dense fog. During this period the solar wall acted merely as "opaque" insulation resulting in a U-value of approx. 0.5 W/m²K. The inner wall surface temperature during this fog period was considerably lower than during the typical winter weather period. The graph shows the frequency of the temperature difference between inner wall surface of the solar wall and the room temperature. The inner surface temperature was equal to or greater than the room temperature more than 80% of the time.

Cost

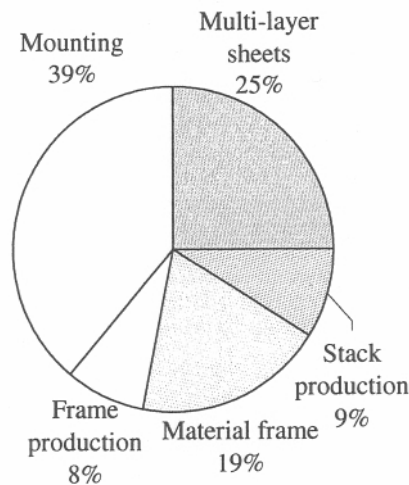

Figure 9: Cost split of the sheet TI system.

Cost split of the TI system for the solar wall heating based on the prototype system.

For small areas (10 to 15 m²) the installation (mounting) contributes a large share to the overall cost. The preparation of the mass wall as an absorber is not included. Preparing the mass wall can be neglected for renovation projects because it would be required also for a standard facade renovation.

This also shows the potential for further cost reduction:

- Reduce fixed part of installation cost (e.g. mounting by the standard facade contractor).
- Material reduction for the multi-layer sheets.
- Cost reduction for the frame material.

TI system for solar wall heating	Investment cost [in €]	Yearly energy gains, south [kWh/m ²]
Prototype 2-stack multi-layer PC sheet	2 700	70
Glazed honeycomb system	5 400	120

Calculated investment cost of a small facade (12.5 m²) with 5 identical TI modules based on the cost for the prototype and specific energy gains per heating season.

For comparison, the cost of a glazed TI system with the same size is given.

For both cases the same parameters are assumed (e.g. wall material).

Conclusions

The measurements of the prototype confirmed the calculated solar gains.

- The system has a cost reduction potential by optimisation of the framing system.
- The cost target of E 280 per m² seems feasible for large identical modules (> 2.5 m²) in moderate quantities (more than 5 modules per order).

Over all conclusions

- This transparent insulation system for solar wall heating applications lowers the investment cost by approx. 50% compared to the known glazed systems.
- The cost reduction can be achieved mainly through a simplified construction for fixing the TI material to the facade.
- Energy gains are reduced to about 60% of a glazed system with honeycomb or capillary TI material.
- The reduced solar gains allow for applications without active solar gain control.
- The framing system allows the combination with and integration in any standard facade insulation system.

9.8 Elimination of thermal bridges with TI (NL)

Specification

Concept description

Transparent Insulation (TI) is most effective on non-insulated mass walls. TI applied to cavity walls may eliminate thermal bridges. In the solar renovation of the Brandaris in Zaandam, The Netherlands, the possibility of TI elements glued to the wall was studied.

The Brandaris is a high-rise multifamily building with 384 apartments. The building's long facade face east and west. There are structural thermal bridges in the cavity walls at the south facades because of the construction of the concrete floors.



Figure 1: View of the Brandaris apartment building

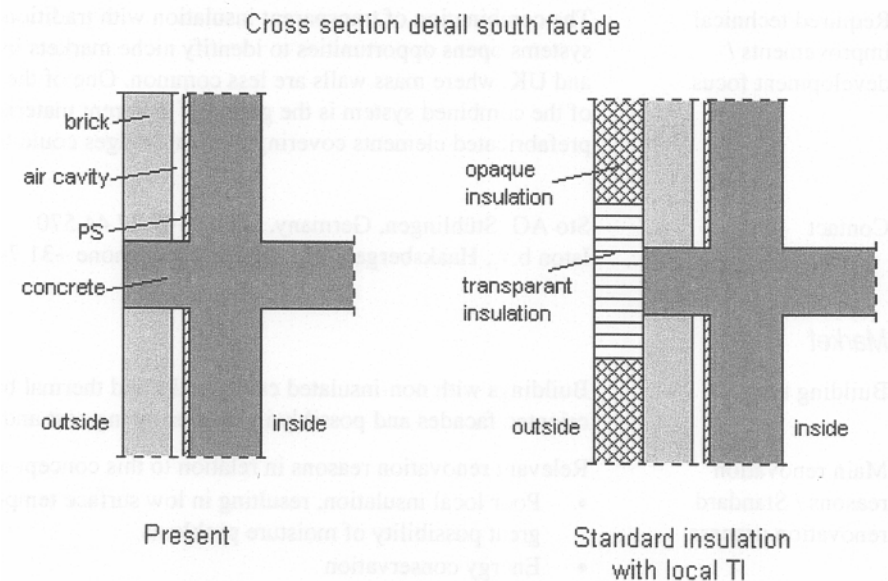

Figure 2: Cross section detail of south facade

Specific energy savings/energy gain	<ul style="list-style-type: none">• Reduction of transmission losses of to 35 kWh per m length of exposed floor edge per heating season.• Solar gains of up to 10 kWh per m length of exposed floor edge per heating season.
Innovative aspects for renovation	<p>The innovative aspects are</p> <ul style="list-style-type: none">• Use of passive solar energy to solve thermal bridge problems and improve thermal (winter) comfort with a solar energy net surplus without overheating in summer• Integration of transparent insulation with traditional exterior wall insulation systems on cavity walls
Critical aspects	<p>Critical aspects are</p> <ul style="list-style-type: none">• Possibility of high local temperatures in the construction behind the TI during summer• Architectural considerations• Environmental aspects• Costs
References	<p>Donze, G.J. a.o.; Renovatie Brandaris, Bouwfysica, vol.9, 1998, no. 1 (in Dutch) Knapen, M; Environmental considerations on materials in TI and possibilities for improvements, IEA SHCP Task 20, 1-98</p>

Development

Development status	<p>Transparent insulation as technology has passed its prototype phase. It has been applied in various shapes in a number of demonstration projects in Germany, Switzerland and Austria. In Germany the manufacturers Sto AG has launched a TI application which can easily be combined with EPS external insulation.</p>
Involved Systems/Components	<ul style="list-style-type: none">• Composite TI systems (Sto AG)• Exterior wall insulation systems
Type of companies involved in development	<ul style="list-style-type: none">• Manufacturers• Architects• Building owners• Energy consultants
Required technical improvements / development focus	<p>The combination of transparent insulation with traditional external insulation systems opens opportunities to identify niche markets in countries like Netherlands and UK, where mass walls are less common. One of the environmental drawbacks of the combined system is the gluing of different materials. The application of prefabricated elements covering thermal bridges could be seen as a solution.</p>
Contact	<p>Sto AG, Stuhlingen, Germany, phone +49 77 44 570 Iston b.v., Haaksbergen, The Netherlands, phone +31 743 575 473</p>

Market

Building type	<p>Buildings with non-insulated cavity walls and thermal bridge problems in south oriented facades and possibly in facades facing east and west</p>
Main renovation reasons / Standard renovation process	<p>Relevant renovation reasons in relation to this concept are</p> <ul style="list-style-type: none">• Poor local insulation, resulting in low surface temperatures on the inside and a great possibility of moisture problems• Energy conservation• Upgrading exterior

Application potential	There is a theoretically large potential for transparent insulation of south (and possible east and west) oriented linear thermal bridges in apartment buildings throughout Europe. The potential impact of the TI part is about 10%-20% to the total standard insulation area.
Cost target	The Dutch market would accept €140 per m ² where the costs of TI elements at the moment are about €230 per m ² .
Additional benefits	Advantages of local TI are: <ul style="list-style-type: none"> • Solar gains and energy conservation • Solving thermal bridge problems • Thermal comfort • Improved architectural image
Contractor/builder / additionally required experts	<ul style="list-style-type: none"> • Architects • Facade company • Energy consultants
Application examples	None within The Netherlands yet

Modelling

Model description The modelling was done for the abutting detail of the concrete floor to the end facade facing south.

Material characteristics:

- Characteristics of the existing detail

	material	thickness [mm]	conductivity [W/(m.K)]
wall	brick	100	1.2
	air cavity	50	-
	PS	15	0.045
	concrete	200	2.0
floor	concrete	200	2.0

- Characteristics of the existing structure:
- U-value of the opaque insulation: $U=0.32 \text{ W}/(\text{m}^2 \cdot \text{K})$
- U-value of the TI-system (100 mm TI): $U=0.80 \text{ W}/(\text{m}^2 \cdot \text{K})$
- Total energy transmittance of the TI-system (diffuse): $g_{\text{dif}}= 45\%$

Simulation model for energy related simulations (CAPSOL and SECTRA)

Simulation characteristics:

- Inside: constant temperature of 20°C
- Outside: standard Dutch climate (Test Reference Year, De Bilt)

Simulation of temperatures in 5 nodes (output):

- Temperatures in the construction directly behind the TI in 4 nodes
- The inner surface temperature in node 5

Cross section detail south facade

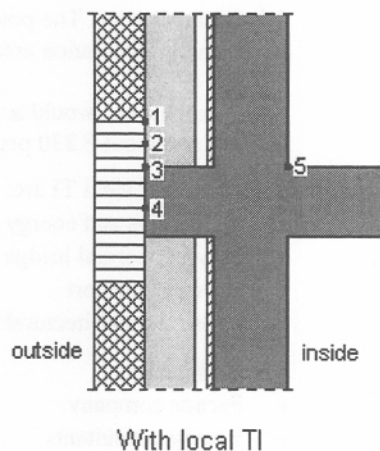

Figure 3: Schematic of simulation model with the evaluated temperature nodes.

Parameters

Specific set of parameters:

- Season: Winter, spring and summer
- Construction: Present detail, detail only with external insulation and detail with external insulation and local TI

Evaluation Criteria's

The evaluation criteria's are:

- Temperature inside the construction
- Reduction local heat flow

Evaluation Tool(s)

CAPSOL, a multi-zone transient heat transfer program (Physibel)
 SECTRA, a 2-dimensional transient heat transfer program (Physibel)

Evaluation Results

Results Criteria 1
 Temperature inside the construction

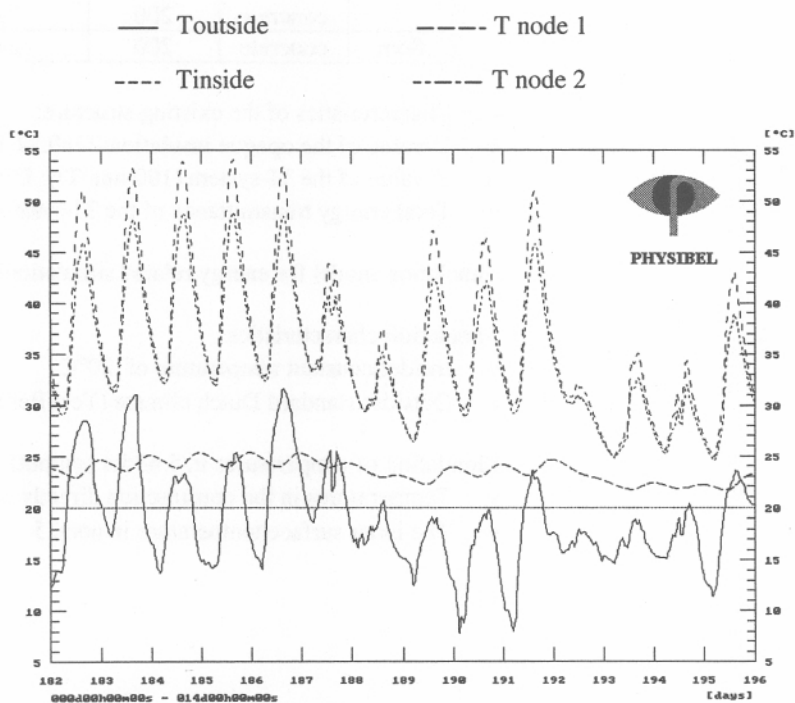

Figure 4: Temperature curve in construction, summer (1 Jul. – 15 Jul.); position of temperature nodes see figure 3.

Due to the angle dependent solar transmittance and the thermal mass of the building construction the difference between the highest temperatures in the construction is negligible during summer and spring. Possible materials stress effects and cracks in the outer shell are not expected from performed simulations.

In summer the time lag of the surface temperatures between the outside and inside of the construction is about 10 hours. This means that the highest temperature on the inner surface arises in the evening. The temperature fluctuation on the inner surface of the construction is about 10% of the outside surface. The inside surface temperature remains below the 25°C, so overheating during summer will not occur. During the winter period the inside surface temperature is minimum 18°C.

Results Criteria 2
 Reduction local heat
 flow

According to the diagram the application of only standard external insulation reduces the heat loss during the heating season by 75% compared to the present situation.

Despite of the lower local insulation, the use of standard external insulation with 60 cm TI shows a positive heat gain over the total construction in the heating season.

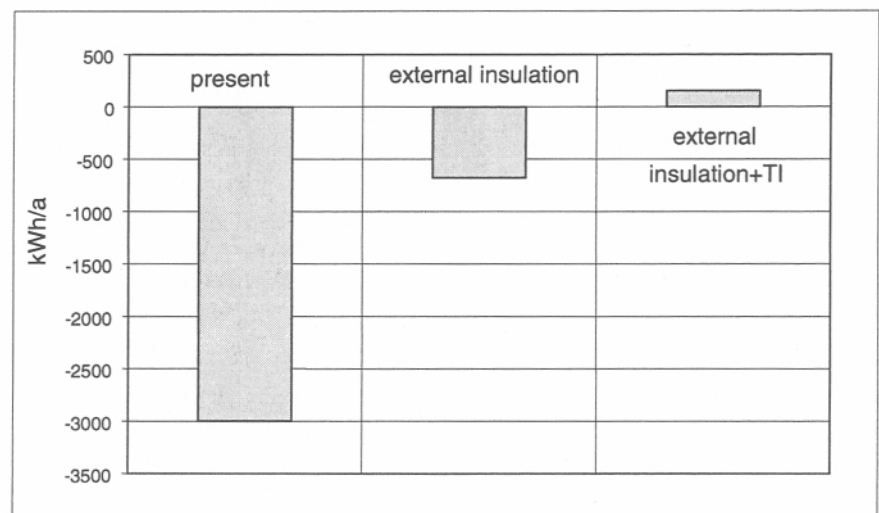

Figure 5: Heat flows over total construction in heating season

The specific heat flow reduction and the solar energy gains by the transparent insulation of the concrete floor sections can also be estimated like follows:

- Specific (linear) heat loss factor for the concrete floor edge exposed to the ambient: -- 0.5 W/(m.K)
- Heating degree days in Amsterdam: 3065 Kd
- Transmission losses: — 35 kWh per meter floor edge and heating season. It is expected that these losses will be compensated.
- Solar energy gains per meter floor edge: It is assumed that only the concrete (20 cm height) will actively store the solar energy. Thus 20% of the figure specified for solar gains of the TI wall heating system may be assumed (— 10 kWh per meter floor edge and heating season).

Conclusions

- Besides the application of TI on massive walls, TI can be used in combination with standard external insulation systems on south oriented cavity walls to eliminate linear thermal bridges.
- Depending on the situation before renovation, TI insulation of exposed concrete floor sections can save up to 100 kWh of heat energy per meter edge and heating season.
- Overheating during summer will not occur and instead of transmission losses there is a positive heat gain and an increase of comfort in winter. The cold bridge becomes a warm one!
- Due the frame-integration with standard external insulation systems and the possibility of reuse and recycling prefabricated TI wall elements with wood or thermally insulated metal frames are preferred instead of TI elements glued to the wall.

9.9 Facade integrated collector system (D)

Specification

Concept description The proposed solar collector system is designed as an integral part of a compound insulation and finish system for building walls. The dark coloured surface of the plaster acts as an uncovered absorber for solar radiation. The plaster layer conducts heat to a plastic capillary piping system then transfers the heat to the domestic hot water (DHW) storage. A layer of insulation thermally separates the piping from the wall. The system collects solar gains and recovers part of the transmission losses of the building wall. Due to the absence of an absorber cover, the application is limited to preheating the water.

The development is part of a co-operation with industrial partners.

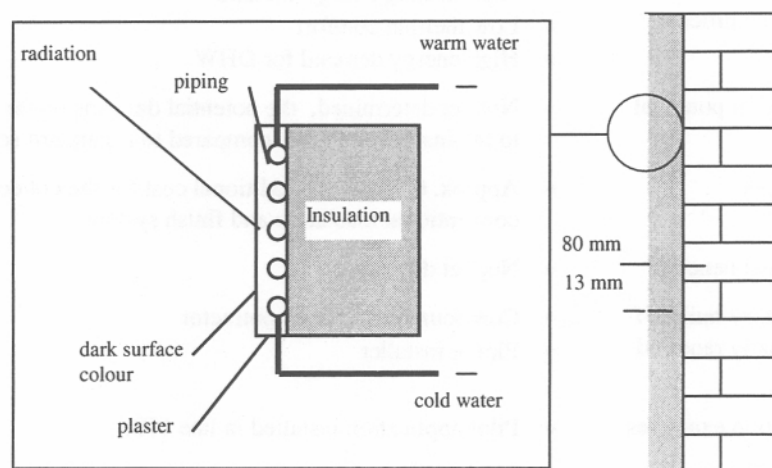

Figure 1: Basic system design of the facade integrated collector system.

Specific energy savings/energy gain Results from testing the facade are available but not yet in a publishable format (finished diploma work).

Innovative aspects for renovation

- Installation as an integral part of a compound insulation and finish system
- "Low cost collector" (intention)

Critical aspects

- Fluid freezing in the collector tubes
- System costs
- Facade (absorber) colour

References Diploma work at Fraunhofer ISE (DE): Untersuchung und Simulation eines Fassadenkollektors zur Brauchwasservorwärmung, Mathias Langer, 1996

Development

Development status

- Evaluated facade performance through simulation and monitoring in 1996
- A pilot application was installed as part of a building renovation in 1998. Performance will be monitored and analysed by Fraunhofer ISE under contract to the manufacturer.

Involved systems/components

- Compound insulation and finish system
- Plastic capillary piping (standard part of cooling ceilings)

- Required technical improvements/ development focus
- Basic system specifications and system layouts to be developed
 - Initial experiences with the system operation are needed to develop a reliable collector facade.
- Type of companies involved in development
- Compound insulation and finish system manufacturer
 - Manufacturer of plastic capillary piping
- Contact
- Fraunhofer ISE, Dipl.-Ing. Mathias Rommel (e-mail: rmmel@ise.fhg.de)

Market

- Building type
- Residential buildings with west or south west (!) oriented external walls
 - Buildings having a central DHW system
- Main renovation reasons / Standard renovation process
- Facade degradation
 - High heating energy demand
 - Low thermal comfort
 - High energy demand for DHW
- Application potential
- Not yet determined, the potential depends on the ratio of system performance to the installation costs compared to a standard solar collector arrangement.
- Cost target
- Approx. E 50 per m² additional cost for the collector compared to a conventional insulation and finish system
- Additional benefits
- Not yet determined
- Contractor / builder / additionally required experts
- Compound insulation contractor
 - Piping installer
- Application examples
- Pilot application installed in late 1998

Experiments

- Experiment description
- A facade collector with an absorber area of 13 m² was installed at a test house on the Fraunhofer ISE test grounds. The collector consists of:
 - 13 mm blue coloured plaster (a=87%)
 - 13 m² capillary piping made of polypropylene with an internal diameter of 1,5 mm
 - 80 mm rock wool insulation
 - 200 mm lime stone brick wall

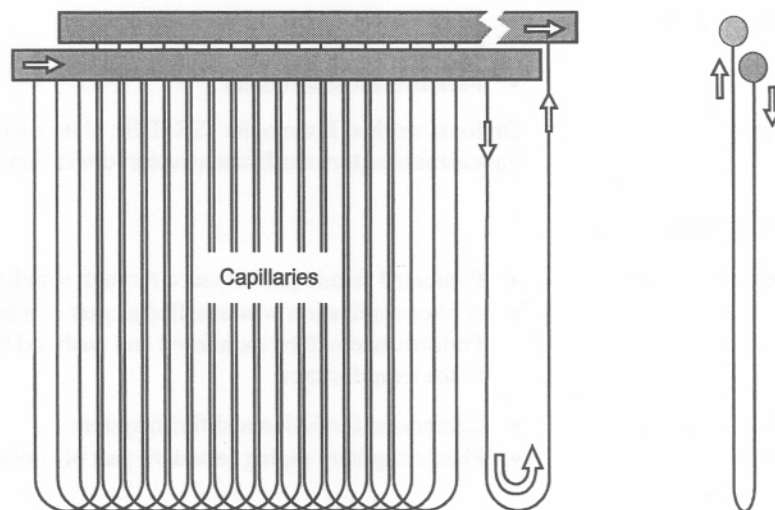

Figure 2: Principle of capillary piping.

- The collector was operated with a cooling unit to maintain a constant low collector inlet temperature
- Results
- The optical efficiency of the collector was determined to be 56% (useful heat delivered per aperture area and insulation). This is about 25% less compared to standard glazed flat plate collectors. One reason for the lower performance is the relatively low absorbance of the facade colour (87% compared to 95% of a selective metal absorber). A second effect is the lower thermal conductivity of the plaster around the capillary piping compared to a metal absorber of a flat plate collector.
 - The heat loss factor of the collector is determined to be approximately 10 W/(m².K) compared to 4 W/(m².K) for a standard flat plate collector. This increased heat loss is the direct consequence of the missing absorber cover.
 - In low-flow operation the capillary tubes tend to non-homogeneous flow rates across the absorber area. This has a significantly negative effect on the overall system performance.
- Conclusions
- The test results are in agreement with initial estimates.
 - Improving the colour and the conductivity of the absorber has a high potential for increasing the collector performance.

Modelling

Model description

- Modelling was done with TRNSYS 14.2 using the measured collector efficiency function as input for type 1 (solar collector)
- Simulations were performed for the collector system "installed" at a 30-family apartment house in Freiburg, Germany, with a DHW demand of 35 litre per person per day. The collector is connected via an external heat exchanger to the stratified boiler. The boiler temperature in its upper part is maintained at a constant 50°C by back-up heat.
- Simulation data were also compared to the measured performance of the test facade. The comparison shows that the absence of an absorber cover resulted in strong fluctuations of the collector efficiency with the weather conditions. It is assumed that the annual results are in sufficient agreement with the simulations.

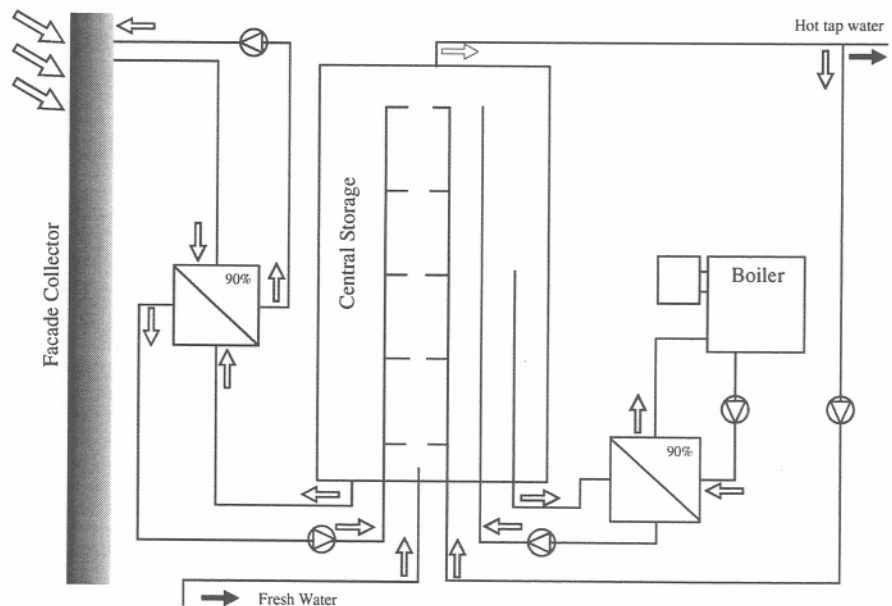

Figure 3: Basic system layout for the simulation.

Parameters	<ul style="list-style-type: none">• orientation• temperature set point in the boiler• system economy
Evaluation Criteria	<ul style="list-style-type: none">• energy savings
Evaluation Tool(s)	<ul style="list-style-type: none">• TRNSYS 14.2

Evaluation Results

Results	<ul style="list-style-type: none">• Using a south oriented and an absorber installation area of 1.5 m² per person, a solar fraction of 25% of the annual DHW demand can be achieved.• Compared to a south orientation, an orientation towards west decreases the solar fraction by only 9% whereas orientation towards east leads to a 24% decrease. The strong coupling of the absorber performance to the ambient temperature (high loss factor) results in a greater efficiency decrease for east-facing collectors compared to west-facing collectors. Maximum solar gains on facades oriented towards the west coincide with the highest daytime temperatures.• The collector yield is decreased by 25% in cases where the storage temperature is heated once a day to 60°C for hygienic reasons (legionellea). Therefore, other methods should be preferred for hygienic protection.• A comparison of the collector yield with costs and yield of a standard flat plate collector system leads to the conclusion that the upper cost range for the facade integrated collector is about €50 per m².
Conclusions	<ul style="list-style-type: none">• A full-scale pilot application was installed to verify the simulation results. This installation includes design modifications derived from the experimental investigation at the test collector (absorber performance, flow rate). The whole system design accounts for the fact that the collector is mostly preheating the water. Generally, it must be stated that this new product is in an early stage of development compared to standard flat plate collectors. The pilot application was installed on a facade of an existing building in late 1998. Measurements will be done under contract to the industry in 1999.

9.10 Solar air - double envelope (S)

Specification

Concept description

The described concept utilises solar heat for space heating by using a simple solar air collector in combination with a double envelope (e.g., a new facade placed at a distance from the existing facade). Solar heated air circulates from the solar air collector, through the double envelope, and back to the solar air collector in a closed loop.

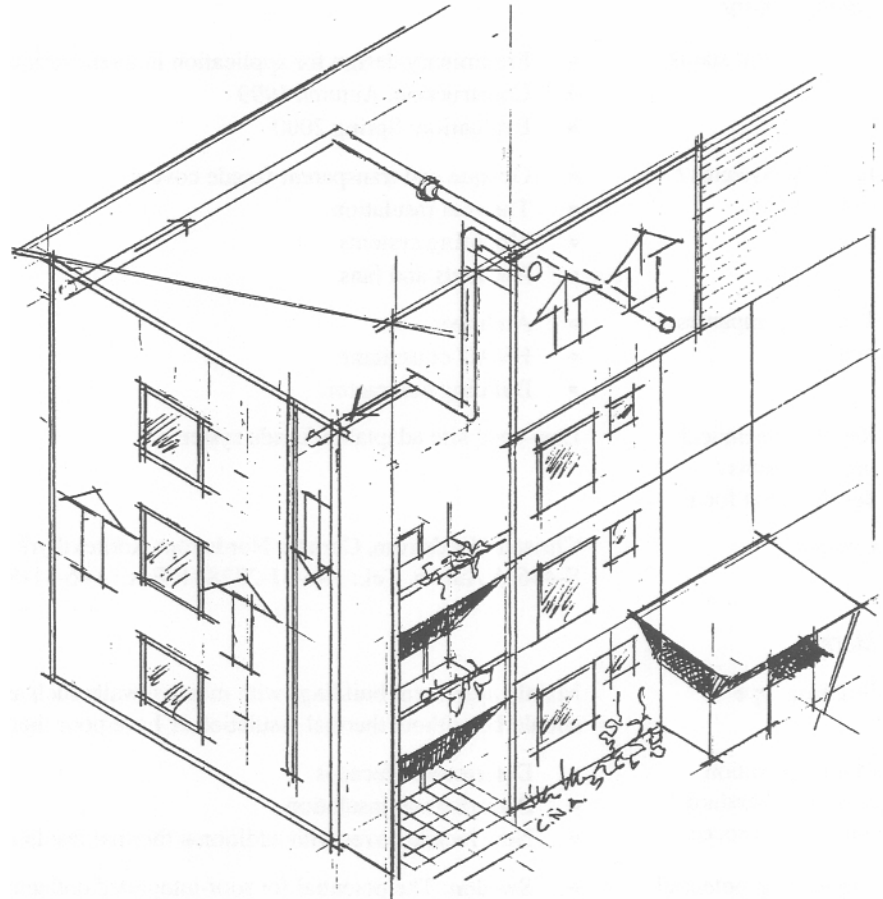

Figure 1: The illustration shows a schematic drawing of the solar air system with double envelope. Courtesy of C. Nordström.

The concept was developed based on the Solar House in Jarnbrott, Sweden, documented in IEA SHC Task 20 Subtask A. Considered improvements are:

- Vertical instead of inclined (roof) collector mounting to increase gains in autumn and spring.
- Simplify system for wall heating only and exclude summer operation for pre-heating DHW (air-water heat exchanger).
- Double envelope on north, west and east facades instead of all facades
- Guide the warm air to the bottom of the facade and extract the air from a top corner instead of the other way round.

Specific energy savings/energy gain

- Compensate part of the transmission heat losses, approximately 10-20 kWh per m² heated floor area.
- The project designers estimated that the required energy is small compared to the gains (see Jarnbrott project in references below).

Innovative aspects for renovation	Solar collector and double envelope design.
Critical aspects	<ul style="list-style-type: none">• Air tightness - double envelope and collector• System control
References	IEA SHCP Task 20 brochure: Solar Collectors in Building Renovation IEA SHCP Task 19 "Solar Air Systems" Design Guidelines

Development

Development status	<ul style="list-style-type: none">• Preliminary design for application in a renovation project.• Construction: Autumn 1999• Evaluation: Spring 2000
Involved Systems 1 Components	<ul style="list-style-type: none">• Opaque and transparent facade covers• Thermal insulation• Mounting systems• Air ducts and fans.
Type of companies involved	<ul style="list-style-type: none">• Architect• HVAC consultant• Building contractor
Required technical improvements / development focus	Low-cost, site adaptable facade systems.
Contact	Christer Nordstrom, Christer Nordstrom Arkitektbyrå AB, Asstigen 14, S-43645 Askim, Tel.: +46-31-282864; Fax.: +46-31-681088; E-mail: cna@cna.se

Market

Building type	Mainly apartment buildings with massive walls such as concrete or brick. Walls should be without thermal insulation or have poor thermal insulation.
Main renovation reasons / Standard renovation process	<ul style="list-style-type: none">• Deteriorated facades• Poor thermal insulation• New facade cover with additional thermal insulation
Application potential	<ul style="list-style-type: none">• Sweden: The potential for roof-integrated collectors (based on renovation needs) is estimated to — 650 000 m² (according to IEA SHCP Task 20 Subtask A investigations). The potential for solar air collectors and double envelopes may be seen as a possible solution when the facades are suitable. The system requires about 5 m² of facade area per m² of collector area (rule of thumb). Assuming that the system can be applied on one third of the buildings suitable for collectors, the potential facade area amounts to — 1 000 000 m² for Sweden.• Europe: The potential is assumed to be larger in other parts of Europe, as uninsulated buildings are more common in less cold climates.
Cost target	The thermal gains are estimated to 100 to 150 kWh/a per m ² collector area, which implies that the marginal cost (e.g. compared with traditional facade renovation) should amount to approximately £ 100 per m ² collector or €20 per m ² facade.
Additional benefits	Increased thermal comfort due to increased wall temperature (indoors).
Contractor / builder / additional required experts	Supervisor for advice and quality check regarding air tightness
Application example	Gardsten, Goteborg, Sweden

Figure 3 shows two sections (supply and return air ducts) of the site-built collector, to be applied to the south-facing facade. The proposed airflow amounts to about 50 m^3 per m^2 of collector area.

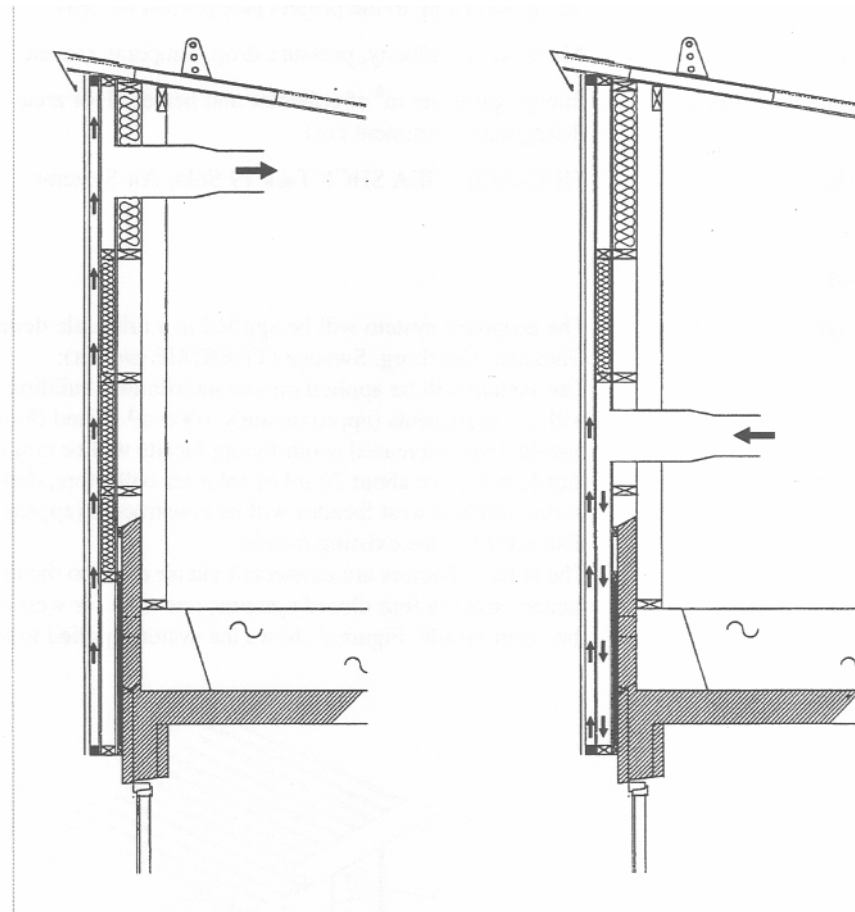

Figure 3: Solar air collector with collector supplies duct (right) and return duct (left). Arrows indicate the airflow. Courtesy of C. Nordström.

Design description
(cont.)

Figure 4 shows a section of the north facade with the new facade cover including thermal insulation at a distance of about 50 mm from the existing facade (concrete elements). The air is guided from the air duct to the bottom of the wall and extracted from the opposite top corner of the double envelope section with another air duct.

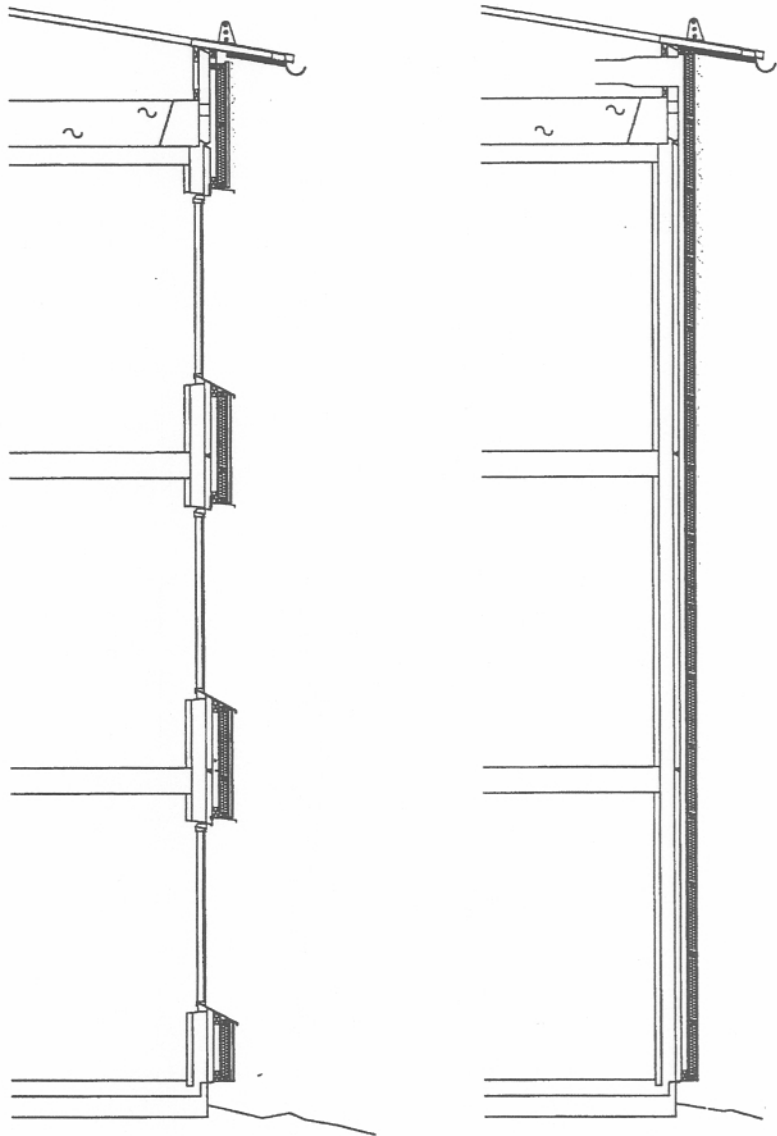

Figure 4: Double envelope: Facade part with windows (left) and closed facade part (right). Courtesy of C. Nordström.

Conclusions

- With the help of state of the art rule of thumb design rules it was possible to create a convincing design for a specific building.
- It seems possible for an ordinary building contractor to build the system within the given cost limits of the demonstration project.
- Evaluation will show what further work is required on the level of research and development.

9.11 Solar air system with building double envelope (CH)

Specification

Concept description

Circulating collector-warmed air through a hollow building envelope reduces heat losses through the building envelope. The system can work at a high efficiency due to the relatively cool temperature of the air returning to the collector. In summer, a by-pass from the collectors to an air-water heat exchanger preheats domestic hot water.

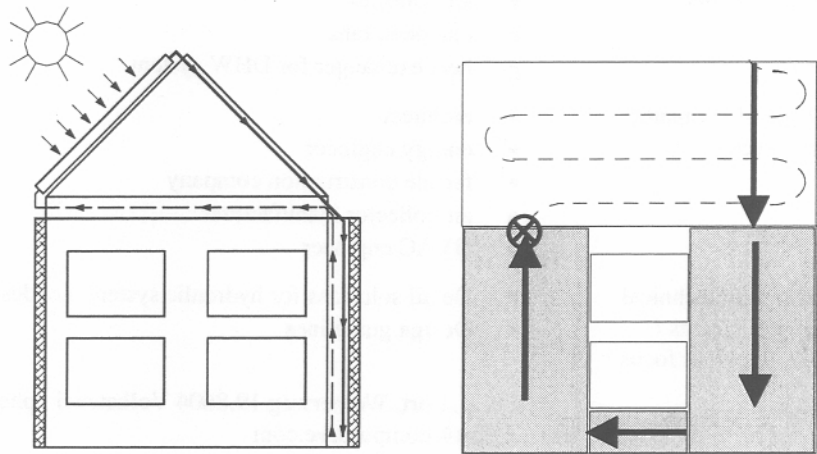

Figure 1: Hydraulic schematic. Air collectors on south oriented roof and airflow through north roof and north oriented facade.

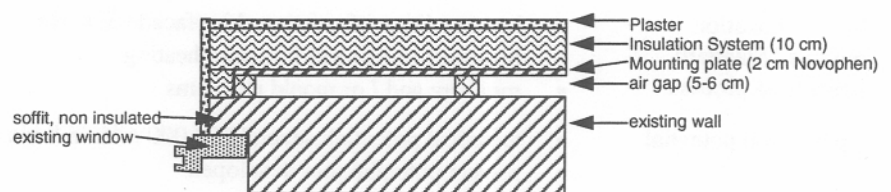

Figure 2: Horizontal section of a suitable double envelope construction.

Specific energy savings/energy gain

Energy savings for a well designed system (air gap 5-6 cm, insulation 10 cm, double envelope facade / collector area ratio = 5 / 1): approximately 100 kWh/(m².a) (area of absorber) in the Swiss midland

Innovative aspects for renovation

- Evaluation of concept for renovation of a typical Swiss apartment building from the 1960s to 1970s
- Evaluation for other climatic situations
- Optimisation of system parameters

Critical aspects

- Air tightness of the second skin
- Connection of ducts to facade cavity
- Hydraulic system: pressure profile
- Electricity consumption of fan

References IEA SHCP Task 19: Solar air systems - Product catalogue
S.R. Hastings, Solar air systems - Built examples; James & James (Science Publishers), 1999

Development

Development status

- air collectors and double envelope: Qualified concept and system model
- summer operating mode with DHW production: proven concept

Involved Systems / Components

- double-skin facade / double envelope construction
- air collector
- dampers, fans
- heat exchanger for DHW system

Type of companies involved

- architect
- energy engineer
- facade construction company
- air collector manufacturer
- HVAC engineer

Required technical improvements / development focus

- Detail solutions for hydraulic system, i.e. design of ducts, facade cavities, etc.
- Design guidelines

Contact Dr. K. Fort, Weiherweg 19,8604 Volketswil , phone +41 1 / 946 08 04, e-mail: k_fort@compuserve.com

Market

Building type

- small to medium sized multifamily houses
- possible also for small office buildings
- best suited for larger facade areas with few or no openings

Main renovation reasons / Standard renovation process

- bad condition of existing skin (facade & roof)
- high energy demand for space heating
- moisture and / or mould problems

Application potential

- technical potential: several 100 000 m²/a in Switzerland
- market potential: not developed

Cost target Cost evaluation of the system is pending at the time of reporting

Additional benefits

- thermal comfort (higher wall temperature, no moisture)
- preheating of DHW

Contractor / builder / additionally required expert Not evaluated in project.

Application examples

- Hybrid solar house, Copenhagen
- Solar House, Jarnbrott, Goteborg

Modelling

Model description

- Two stories
- Flat roof
- S-Facade: Width: 5 m, 12 m² windows (frame: 20%)
- N-Facade: 5 m² windows
- E-Facade: Width: 10 m, no windows
- W-Facade: Climatic indoor conditions (adiabatic)

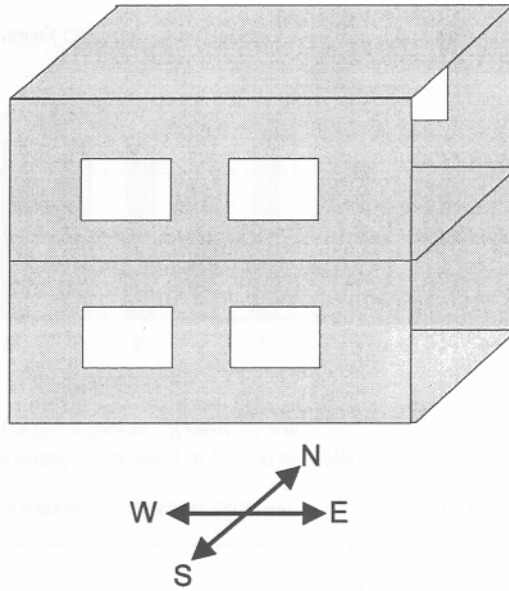

Figure 3: Shoebox model.

Insulation level of building:

U-value [W/m ² K]	Highly insulated	Standard insulated
Roof	0.13	0.35
Wall with double skin facade	0.18	0.47
Other Wall	0.17	0.45
Window	1.60	1.60
Floor	0.19	0.44

Parameters	<ul style="list-style-type: none"> ratio of air collector area to double envelope area orientation and tilt of air collector
Evaluation Criteria	<ul style="list-style-type: none"> energy gains in function of the parameters hydraulic system performance
Evaluation Tool(s)	TrnsAir (IEA SHC Programme Task 19): Dynamic simulation tool for solar air systems based on TRNSYS

Evaluation Results

Energy savings

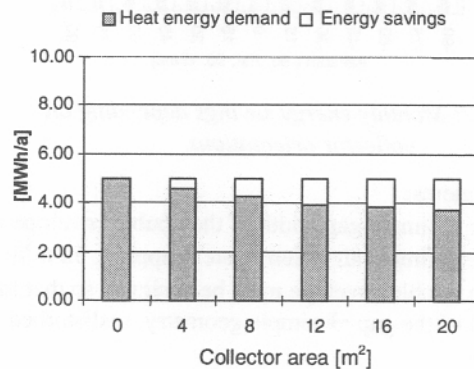

Parameters:

- highly insulated massive building
- 60 m² double envelope
- collector orientation: South
- collector tilt: 45°

Figure 4: Energy savings depending on collector areas for highly insulated building.

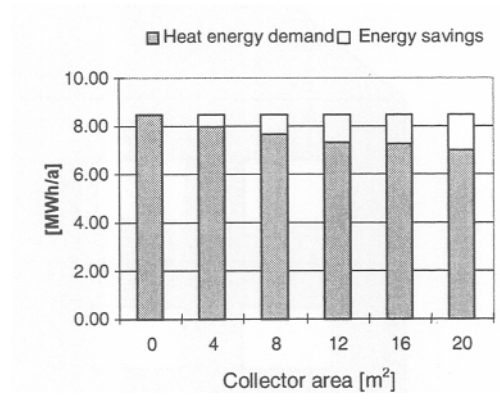

Parameters:

- standard insulated massive building
- 60 m² double envelope
- collector orientation: South
- collector tilt: 45°

Figure 5: Energy savings depending on collector area for standard insulated building.

Relative energy savings

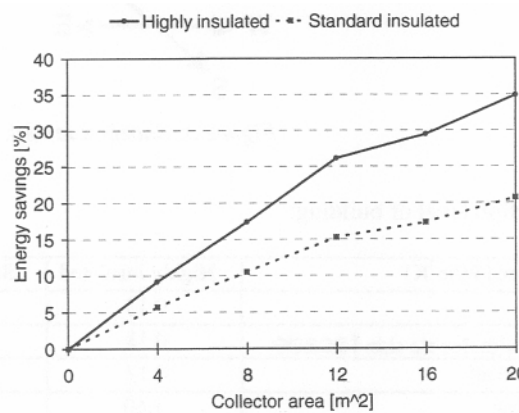

Parameters:

- massive building
- 60 m² double envelope
- different insulation levels
- collector orientation: South
- collector tilt: 45°

The optimum collector / facade area ratio is around 1/5. The relative savings are higher for highly insulated buildings.

Figure 6: Relative energy savings depending on collector area for highly and standard insulated building.

Monthly energy savings

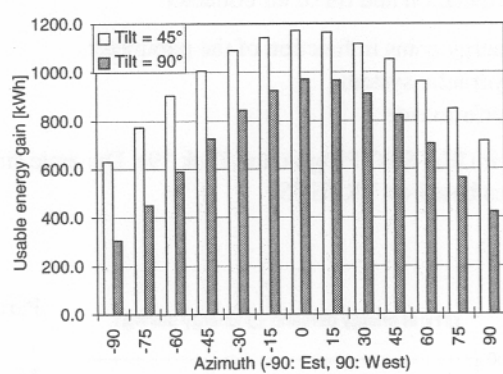

Parameters:

- massive building
- with 60 m² double envelope
- highly insulated
- collector area: 12 m²
- collector orientation: South
- collector tilt: 45°

Figure 7: Monthly energy savings depending on collector orientations.

Hydraulic System

Requirements:

- The optimum gap width of the double envelope is 5-6 cm.
- The optimum air volume rate is approx. 50 m³/h per m² collector area.
- The double envelope must be designed so that the air is circulating in every part of the gap -3 simple geometry, undisturbed facade area.

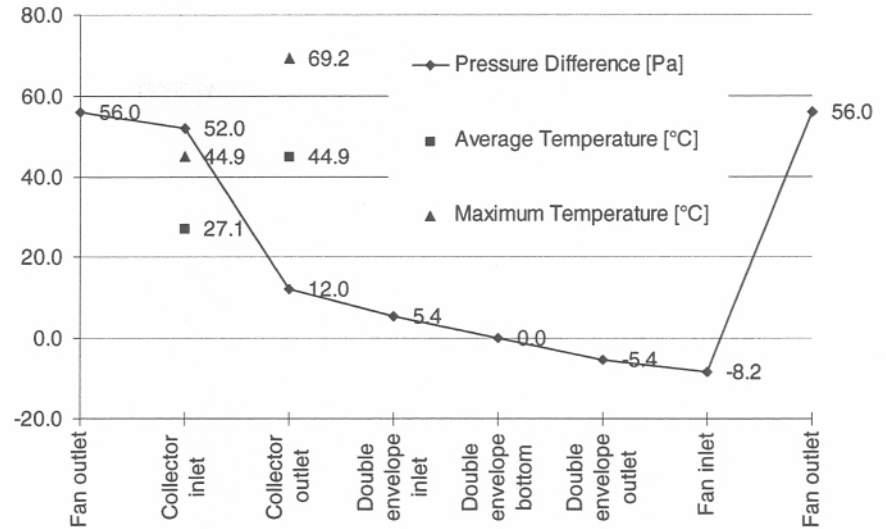

Figure 8: Pressure profile in Pa and average temperatures in °C of a typical system while fan is feeding the collector.

The bottom of the double envelope must be at atmospheric pressure to allow for drainage openings for condensed moisture. The pressure drop in the facade cavity must be minimal to avoid leakage.

Coefficient of performance / electricity consumption of fan

Heat energy saving per electrical energy demand for fan: factor of 15 to 25 (calculated value)

Conclusions

- The optimum collector / facade area ratio is around 1/5. The relative savings are higher for highly insulated buildings.
- The realisation requires relatively high planning efforts. Each project will have unique issues that must be studied individually. To reduce planning cost, the specific designs should be suitable to many similar buildings.
- Further guidelines for typical applications would be helpful.
- There are no specific standard products available for the double skin facade or the double envelope.

9.12 Roof windows with light ducts (US)

Specification

Concept description

Daylighting systems with advanced roof windows and automated lighting controls can decrease a building's energy consumption and increase occupant comfort. The Visitor's Centre at the National Renewable Energy Laboratory in Golden, Colorado, U.S.A., will incorporate this concept in its proposed renovation. Constructed in 1993, the Visitor's Centre is a single story building consisting of display space, conference room, and offices. Its electric lighting was modified in 1996 by replacing incandescent downlights with compact fluorescent downlights and T12 fluorescent lamps with T8 lamps and electronic ballasts. The areas to be renovated include the private offices and the main gallery corridor.

The proposed daylighting modifications will incorporate:

- Solar tracking roof windows with appropriate glazing that are properly sized and oriented to optimise the admittance of daylight relative to heat gains and losses from the windows.
- Automatic controls to operate the electric lighting systems when daylighting is insufficient to meet building lighting needs.
- Daylight distribution systems to help collect, transport, and distribute the light for maximum benefit.

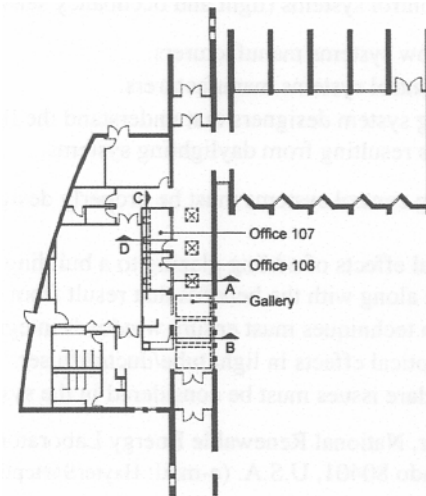

Figure 1: Floor Plan

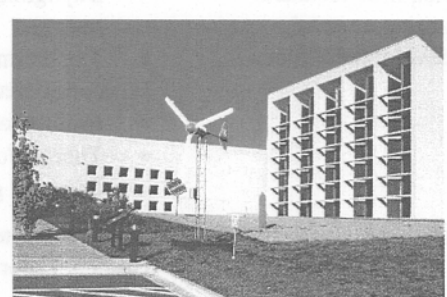

Figure 2: Visitor's Centre Entry

Specific energy savings/energy gain

Computer simulations show:

- Overall building energy savings would be 2 300 kWh while annual energy cost savings would be \$(US)150.
- Office and Galley electrical energy savings would be 2 900 kWh.

Innovative aspects of renovation

- Sun tracking reflectors mounted above the skylights increase early morning and late afternoon daylighting contribution.
- Sun tracking reflectors control glare problems by preventing direct beam radiation in the space.
- Interior reflectors spread and soften the daylight for increased comfort and illumination uniformity.
- Annual lighting energy savings more than compensates for increased winter heat losses and summer gains caused by the roof windows.
- Increases occupant comfort and satisfaction by providing natural lighting and an improved visual connection with the outdoors.

- If sufficient glazing area exists, use of available daylighting can have a significant effect in a building retrofit situation without affecting the building envelope.
- Critical aspects
- Must incorporate properly designed daylighting control system to achieve energy savings.
 - May require new roof penetrations for additional glazing area.
 - May adversely affect the building's heating and cooling loads if daylighting system is improperly designed.
- References
- IEA SHCP Task 21 Daylighting in Buildings reports
 - Light Revealing Architecture, Marietta S. Millet
 - Concepts and Practice of Architectural Daylighting, Fuller Moore
 - Sunlighting as Formgiver for Architecture, William M. C. Lam

Development

- Development status
- Skylights and controls commercially available.
 - System performance/limited characterisation.
 - R&D underway to develop integrated solutions/better performance (glazings).
- Involved systems/
components
- Building roof window systems (glazings/louvers/trackers).
 - Light distribution systems (tube/duct/diffuser).
 - Lighting control systems (light and occupancy sensors).
- Type of companies
involved in
development
- Roof window systems manufacturers.
 - Lighting control systems manufacturers.
 - Daylighting system designers that understand the lighting/thermal load interactions resulting from daylighting systems.
- Required technical
improvements/
development focus
- Daylighting control systems must be properly designed to ensure energy savings.
 - The thermal effects of adding glazing to a building envelope must be considered along with the benefits that result from daylighting.
 - Installation techniques must ensure window's integrity against weather.
 - Thermal/optical effects in light tube/duct/diffuser.
 - Potential glare issues must be considered in the system design.
- Contact
- Sheila J. Hayter, National Renewable Energy Laboratory, 1617 Cole Blvd., Golden, Colorado 80401, U.S.A. (e-mail: HayterS@tcplink.nrel.gov)

Market

- Building type
- Applicable to all building types. Energy savings potential more significant in daytime occupied commercial or industrial buildings where the daytime lighting loads are high and perimeter and/or roof exposure is significant. Solar access and local climate conditions must also be considered.
- Main renovation
reasons / standard
renovation process
- Decrease energy use by building lighting systems.
 - Increase occupant visual comfort.
 - Standard renovation (re-roofing) or energy-efficient lighting upgrade typically does not consider integrating daylighting.
- Application potential
- High. Most commercial buildings contain interior spaces that do not have access to exterior glazing. Installing skylights is a relatively simple retrofit compared to other methods for increasing the building's glazing area. Baffled skylights maximise the amount of diffuse light allowed to enter the building to avoid glare issues. Electric lighting controlled to complement the available daylight decreases overall building lighting loads and lowers building energy and operating costs.

Cost targets	Not evaluated in general
Additional benefits	Improves occupant visual comfort, which, in commercial and industrial buildings, often increases productivity. Productivity benefits, while difficult to verify, will often far exceed the financial benefits of energy savings.
Contractor/builder / additionally required experts	The building designer can evaluate the energy savings potential and supervise the installation of daylighting systems. A window manufacturer often oversees the installation of new/replacement roof windows. The control system manufacturer may oversee the installation of new daylighting controls.
Application examples	<ul style="list-style-type: none"> • Schools in North Carolina • Solar Energy Research Facility (SERF) – National Renewable Energy Laboratory (Golden, Colorado, U.S.A.) • Thermal Test Facility (TTF) – National Renewable Energy Laboratory (Golden, Colorado, U.S.A.)

Modelling

Model description This study focused on the daylighting renovation potential of the Visitor Centre gallery corridor and private offices (figure 1).

The proposed daylighting design for the gallery requires three 1.2 m by 1.2 m tracking mirrored skylights in splayed lightwells (figure 3) between the bank of windows at the southern end of the corridor and the gypsum wallboard soffit at the northern end of the space. This configuration allows uniform spacing of the skylights while avoiding conflicts with structural beams, fire sprinklers, and roof drains, which cannot be economically relocated for this project. Light reflecting baffles located within the lightwells will diffuse the light and prevent direct beam penetration into the gallery to prevent glare problems. A study of available energy-efficient skylights led to the selection of the So-Luminaire Daylighting System. This system includes a bank of four exterior mirrors mounted on a sun-tracking framework below the acrylic dome.

A light shelf (figure 4) with an indirect fluorescent lighting strip will be placed on the eastern gallery wall along the window bank at approximately 2.4 m above the finished floor. Daylight reflected off the light shelf onto the curved fabric reflector will emphasise the reception area at the Visitor Centre entry. The fluorescent lighting strip will provide similar indirect lighting at night.

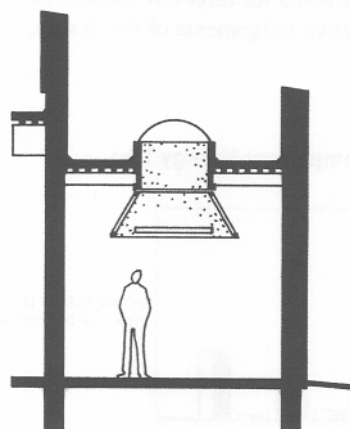

Figure 3: Gallery Skylight

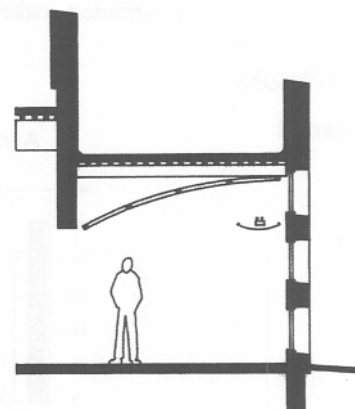

Figure 4: Gallery Reflector

The existing private offices need electric lighting while occupied because they have no access to daylight. A wall wash skylighting design will avoid major obstructions in the ceiling cavity to provide access to daylight while eliminating glare problems on the work. The west wall will be extended to the structural ceiling (figure 5)

where two sun tracking 0.6 m by 0.6 m skylights will be installed.

Splayed reflectors will be used to diffuse and soften the light (Figure 6). This design will provide a pleasing wash of daylight across the major surfaces in the office.

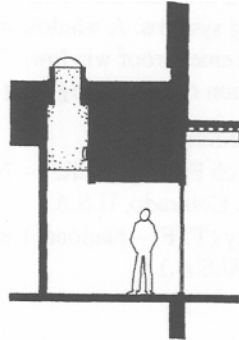

Figure 5. Office Section (West)

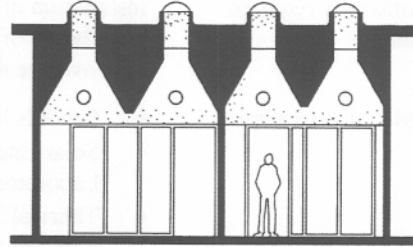

Figure 6. Office Section (North).

Simulations predict that only task lighting at workstations will be necessary during most daylight hours. Two compact fluorescent fixtures are proposed for each lightwell space below the skylights for use during evening and night hours. Two 1.2 m, single T8 fluorescent downlights are proposed for the drop ceiling near the east wall.

Parameters	<ul style="list-style-type: none"> • Daylight availability based on local climate and site conditions. • Retrofit compatibility with existing construction and functions. • Integration potential of daylight and electric lighting.
Evaluation criteria	<ul style="list-style-type: none"> • Achieve annual energy savings at an acceptable renovation cost. • Maintain adequate daylight and electric illumination levels. • Improve user comfort and satisfaction.
Evaluation tool(s)	<p>Computer lighting analysis, including horizontal illumination levels and grey- scab renderings, was conducted with Lumen Micro version 7.5 from Lighting Technologies. Energy analysis was modelled through DOE2 simulations using VisualDOE version 2.6 software from Eley Associates. A physical model at 4.2 = 1 m scale was constructed for direct measurement of illumination and to help the architect make qualitative judgements of the design.</p>

Evaluation Results

Results criteria 1

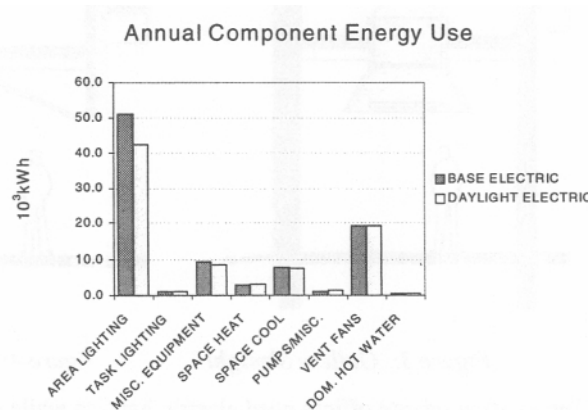

The VisualDOE analysis predicted the energy savings potential of a properly design daylighting retrofit. In this case, a slight increase in the heating and cooling loads was more than offset by electrical energy savings.

Results criteria 2

Office 107: Daylighting, Dec. 12:00

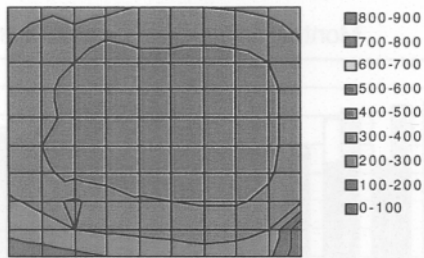

Physical model studies and computer simulations predicted adequate illumination levels in the gallery and offices. Under low daylight levels, supplemental electric illumination will be required.

Office 107: Exist. Electric Lighting

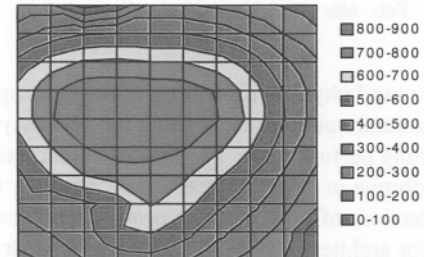

The graphs of the lux levels in the office predict uniform illumination with daylighting in December versus excessive illumination with the existing electric lighting.

Results criteria 3



Lightscape visualisation studies allow designers to visually assess illumination from daylight and electric light. The image on the left shows the illumination in Office 107 with the proposed daylight and supplemental lighting for December 21 at noon.

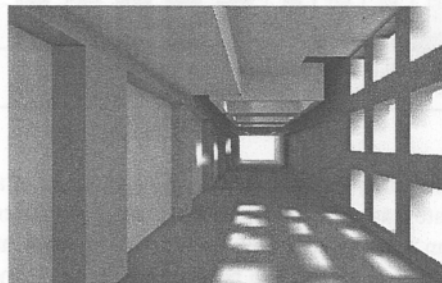

The Lumen Micro program produces grey-scale renderings and luminance readings at any point in the image. This image shows the gallery daylighting at 10:00 on a clear December day.

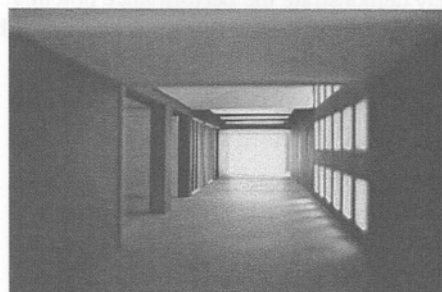

A physical model of the same space produces accurate illumination and a visual realism with sufficient detail. All three tools can help designers make appropriate decisions.

Conclusions

Implementing a daylight retrofit must be done with a careful analysis of the

Energy impact on the entire structure. Increasing the daylight in the Visitor's Centre and installing occupancy and light sensors will decrease building lighting loads. An annual energy analysis demonstrates the trade-offs between heat loss/gain and the electric lighting savings, similar to that shown for the Visitor's Centre.

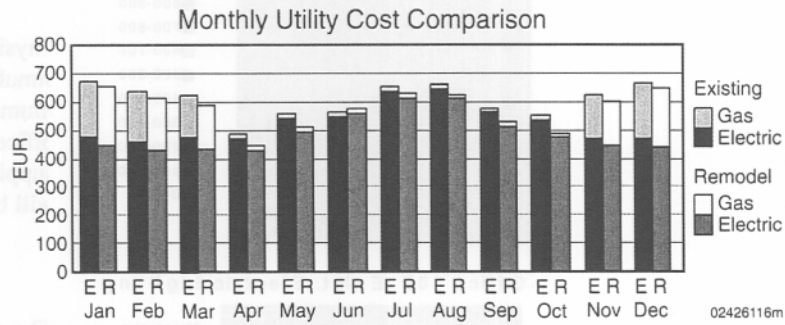

Architects have used physical modelling of daylighting for centuries. Recent studies with miniature photosensors show the accuracy of physical modelling in predicting lighting performance. The cost of constructing detailed, large-scale models is prohibitive in most projects. New computer software that accurately models the behaviour of light in space promises to be a more accessible, cost-effective tool for architects. With tools such as Lightscape, designers and their clients can walk through a digital design proposal and visually assess the design. Both computer modelling and small-scale physical models were developed to analyse the daylighting potential in the Visitor's Centre project.

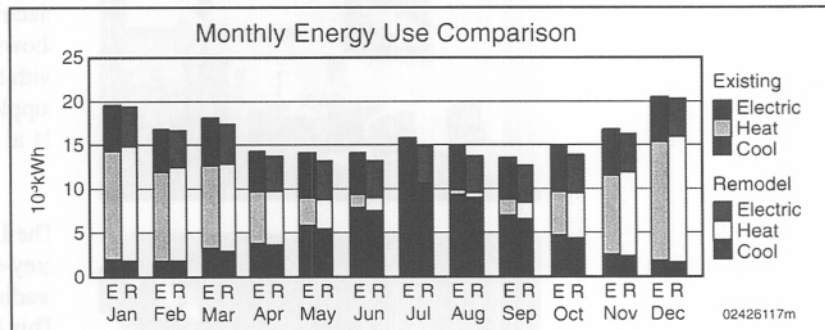

The most significant impediments to daylight retrofits are often the construction and system integration and cost issues. It may be difficult to place appropriate openings in an existing structure and to change the control system of the HVAC plant to work effectively with a new daylighting scheme. While an energy simulation may demonstrate the performance potential of a daylight remodel, a life-cycle cost analysis will show whether such an approach is economically justified.

9.13 Improved daylight for multi-storey housing (DK)

Specification

Concept description

The objective of the present concept is to increase the comfort through the use of direct sunlight reflected deep into the core of buildings. The utilisation of sunlight is a comfort issue and mainly based on the desire of having the quality of sunlight in the rooms rather than directly saving energy.

Sunlight is characterised having almost perfect parallel beams, giving the possibility to redirect the sunlight with plane surfaces having only marginally losses even over large distances. Typical systems consist of one or more moving minors following the Sun reflecting the sunlight towards one or more fixed minors pointing to the rooms or spaces where the sunlight is needed.

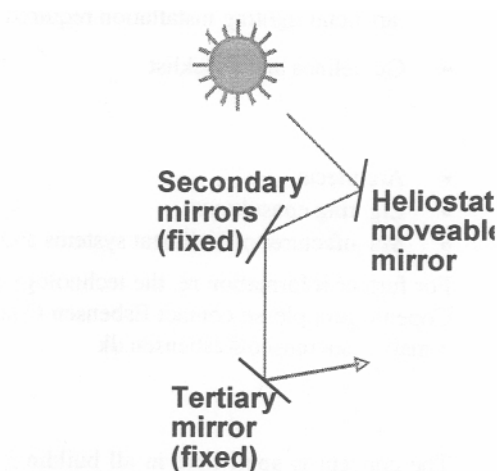

Figure 1: Light guiding principle with Heliostat mirror.

One pilot project is currently being carried out in the centre of Copenhagen (Project Prisme, Hedebygade 5-7) and the concept has proven being of interest to building owners having very deep multi-family housing blocks. In these the core of the building is often very difficult to utilise and giving attractive appearance due to the lack of daylight and sunlight at all times.

Specific energy savings/energy gain

Energy saving is of secondary relevance and part of the positive outcome of the concept. The amount is very dependent on the application and the solution. The amount of sunlight available is proportional to the area of the heliostat and for each subsequent reflection in minors approximately 2% of the sunlight will be lost.

Innovative aspects for renovation

The utilisation of heliostats for apartment buildings.

Critical aspects

- Unobstructed pathway of the direct sunlight
- User acceptance
- Project specific optical components

References

Transmitting Light to Dark Rooms, WREC 1996, R. Whhidi, G. Talehani, A. Afgami Rohani

Further general references: 5 <http://www.dynamics.com/teching.htm> OTH seminar on innovative light technology, January 28./29.1.1999

See also the web-site of the manufacturer which includes examples:

Development

Development status	<ul style="list-style-type: none">• The components for the moving mirror are already industrialised components up to a size of square size of 2.5 x 2.5m.• Additional secondary and tertiary mirrors are unique for most projects, since they have to be directly sized according to specific building geometry. Mirrors of glass can be bought in any size and bearings can be made. For smaller mirrors with weight less than 5kg, the bearings with 360° orientation can be found as standard tripod components from professional photography.
Involved Systems / Components	<ul style="list-style-type: none">• Heliostats including electronic control system programmed for the location• Other mirrors designed from various materials such as polished anodised Aluminium or toughened glass mirrors.• Back up lighting required either via the reflecting system or as traditional artificial lighting installation required.
Required technical improvements / development focus	<ul style="list-style-type: none">• Guidelines and checklist.
Type of companies involved in development	<ul style="list-style-type: none">• Architects• Lighting consultants• Manufacturer of Heliostat systems and other optical systems and parts.
Contact	For further information re. the technology and the specific demonstration project in Copenhagen, please contact Esbensen Consulting Engineers, Mr. Henrik Sorensen: e-mail: h.soerensen@esbensen.dk

Market

Building type	The concept is applicable in all buildings with large distances from the facade to the core of the building, having roofs being exposed by sunlight and providing a vertical route for the light. Especially multi-family housing from the 1960ies period could benefit from this concept.
Main renovation reasons / Standard renovation process	The concept is to be regarded as a supplementary technology providing increased comfort of living in multi-family housing blocks. In the case of renovation establishing new vertical routes for heating, water etc. the extra effort establishing a vertical route for sunlight will be marginal compared to other building costs for establishing technical shafts etc.
Application potential	The application potential is mainly within, renovation of high-rise multifamily buildings with depths of 6 meters or more from the facade to the centre of the building - typically found in the high-density urban areas. Since the heliostat can be located away from the vertical paths, most buildings can be provided with direct sunlight to a secondary mirror.
Cost target	The cost target will vary from country to country and building to building, since the dominant factor is the potential increase in value of the building, when using the system to improve indoor comfort. In the evaluation of a specific project, this potential increase in property value should be carefully compared to the investment in mirror systems, heliostat and controls. A realistic target would be to balance this within the expected lifetime of the heliostat of 20-25 years.
Additional benefits	The direct sunlight will often give a subjective impression of light and friendly areas and potentially reducing the unfriendly and cold climate, especially in multi-family housing blocks of the 1960ies.
Contractor/builder / additionally required experts	<ul style="list-style-type: none">• Manufacturer of optical components for advice to the contractor, both during planning, commissioning and fine-tuning of controls.• Service contracts with manufacturer are typical.

Application examples

So far the pilot project in Copenhagen is the only example of direct use of the proposed system in dwellings. Other building types (warehouses and shopping malls) have been equipped with similar systems for utilisation of sunlight:

Solar light pipe, CADDET IEA/OECD Demo 16, CA 90.011/3B.FO2, Telephone: +31 46 595 224/Telefax: +31 46 528 260

Solar Duct for Lighting and Ventilation Santa Amalia Building, Barcelona, Spain, WREC 1996, O. De-Urrutia Dr. Architect, Pasaje Mulet 2, Bajos, 08006 Barcelona, Spain

Modelling

Model description

Due to the fact that daylighting experiments are scaleable, the proposed system was modelled in a physical model and evaluated with direct sunlight.

The model was designed so that the critical routes of the sunlight could be judged and measurements could be carried out. All surfaces and transparent parts were designed with the same reflectance and appearance as it was intended in full scale.

In the present model the sunlight was directed towards the bathroom and the kitchen, but all other rooms next the vertical shaft could in principal benefit from the direct sunlight.

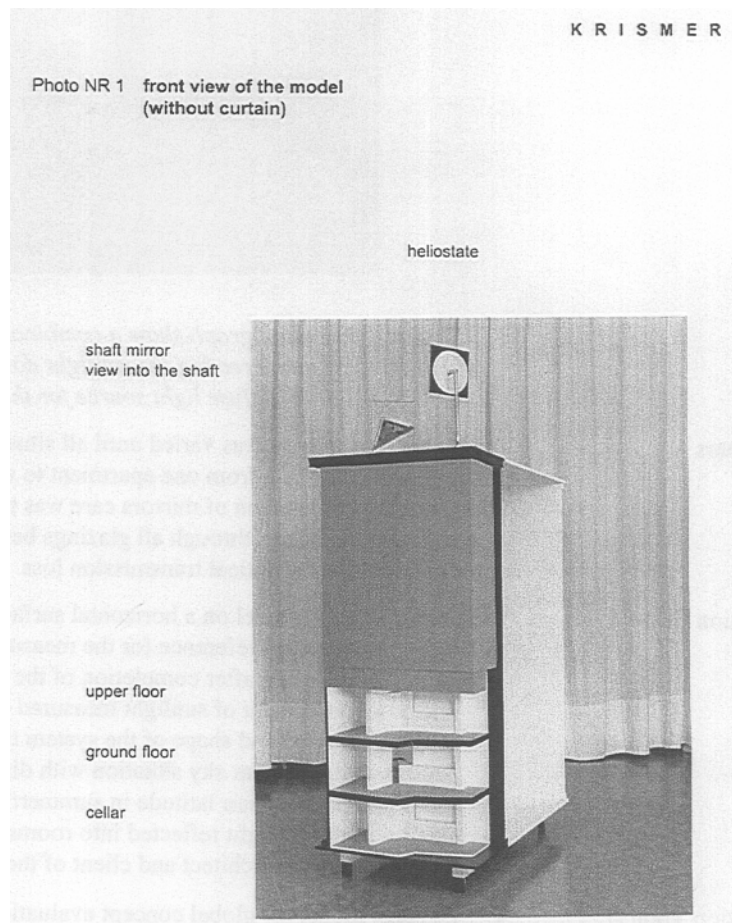

Figure 2: Picture of the model for the evaluation of the light conditions.

The model was designed so that the lighting conditions could be documented both with photographs and measurements. Three different possibilities for design of shaft and tertiary mirrors were tried out in the same model.

K R I S M E R

Photo NR. 7 ground floor with glassing walls adjoining the shaft

$E_{h\text{ bath}} = 530 \text{ lx}$ (horizontal illuminance in the bathroom)
 $E_{h\text{ kk}} = 500 \text{ lx}$ (horizontal illuminance in the kitchen)

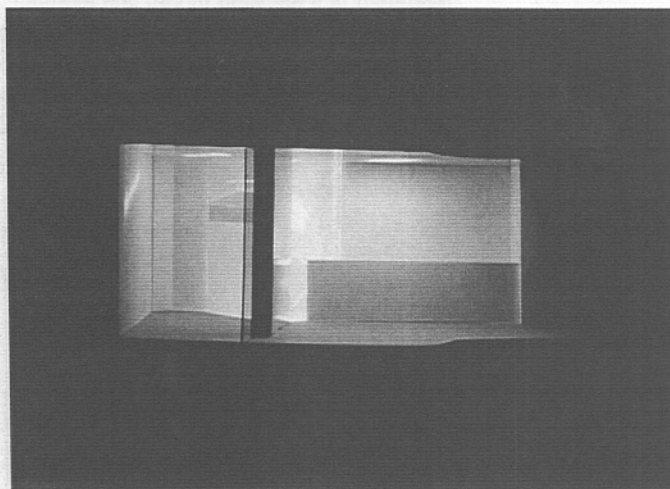

Figure 3: The photograph show a combination of a translucent wall in the bathroom (left) and directing the sunlight down the walls of the shaft to give a diffuse light source for the apartments.

Parameters	The location of mirrors was varied until all situations of direct glare and possibilities for looking from one apartment to another was completely avoided. When varying the location of mirrors care was taken to aim for having perpendicular sunbeams through all glazings between the shaft and bathrooms in order to minimise the optical transmission loss.
Evaluation Criteria	<p>The primary lighting level on a horizontal surface 80 cm above the floor in the bathing room is used as reference for the measurements in the scale model and will be repeated in full scale after completion of the renovation.</p> <ol style="list-style-type: none"> 1. The absolute amount of sunlight measured in lux on horizontal surfaces. In the layout of the size and shape of the system the desired illumination level is min. 200 lux during a clear sky situation with direct sunlight level between 9 a.m. and 3 p.m. at the given latitude in summertime. 2. Quality of the sunlight reflected into rooms: flickering, glare and the subjective judgement by the architect and client of the quality of the system.
Evaluation Tool(s)	<ul style="list-style-type: none"> • Physical model for global concept evaluation and illumination levels • RADIANCE for parametric variations of the transparent parts, shaft interior etc.

Evaluation Results

Results Criteria 1

Illumination was measured with different layout of mirrors in the shaft. In all situations values above the desired 200 lux were achieved in the models. Because the glazing between the vertical shaft and the bathrooms and kitchens have to be of high fire-resistance, the area of the transparent and translucent parts had for economical reasons to be limited. The solution chosen was therefore a combination of the solutions shown below. Between the bathroom and the shaft translucent glass-bricks and 0.5 m² clear double-glazing was installed. The glass-bricks give a pleasant diffuse light and a direct spot of sunlight is directed towards the ceiling in the bathroom. In the kitchen clear glass was integrated above the main working place, providing a spot of sunlight.

Results Criteria 2

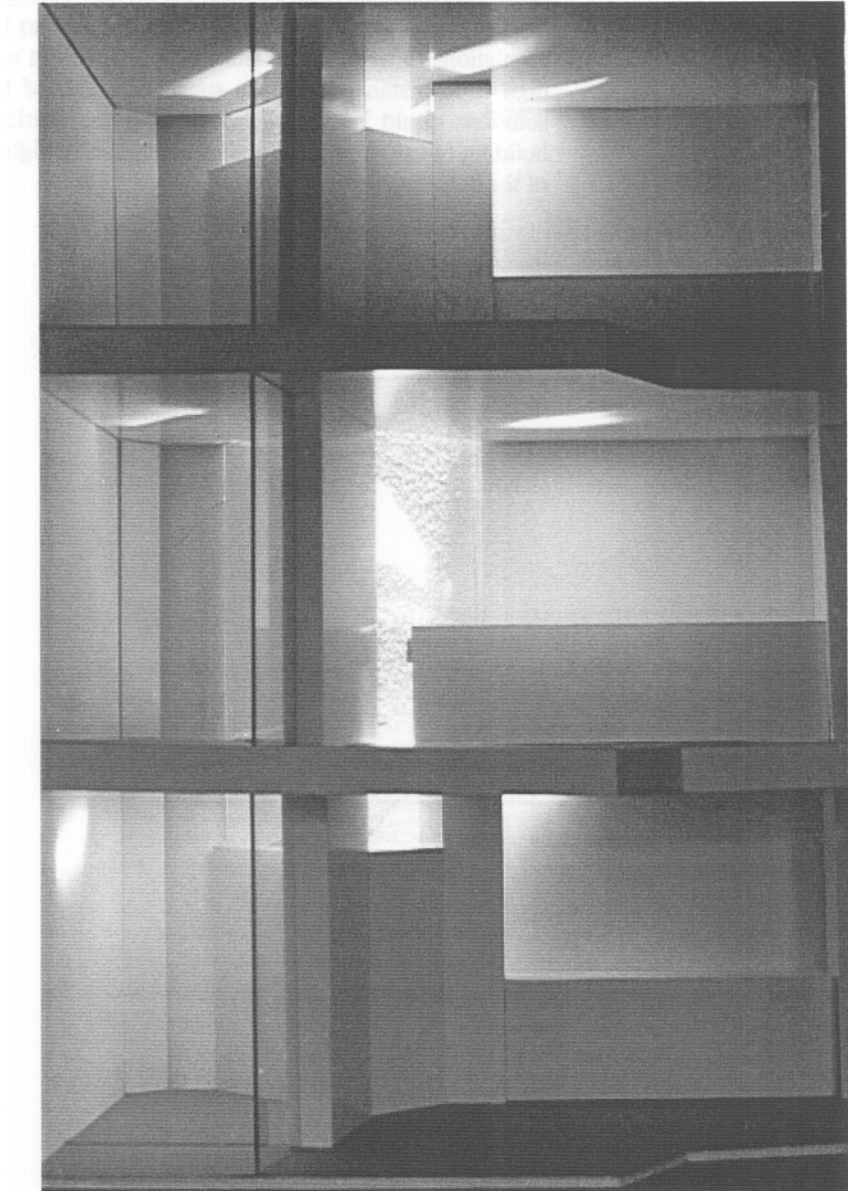

Figure 4: Picture from scale model showing the different options that were combined to the final solution. In the upper situation the sunlight is reflected to the ceiling of the bathroom and the ceiling of the kitchen (the picture is taken from a relatively low viewpoint). In the middle situation the openings to the shaft from the bathroom and kitchen are larger and the mirrors are adjusted so that the sunlight expose the texture of the back wall of the shaft. In the bottom situation the sunlight in the bathroom is directed more horizontally towards the back wall and the kitchen is receiving a relatively smaller part than in the top situation.

Conclusions

- The good visual performance and illumination values of approx. 400 lux in clear sky conditions in the model experiments indicate that the system will perform as predicted and expected during the concept development phase.
- The levels of sunlight achieved in the scale models show that the system within the building blocks can be quite compact, e.g. a shaft of 1.5 x 1.5 could be sufficient for providing sunlight to 2 rooms in 8 apartments.
- Since the costs are rather high, in the present project around €55 000 for the heliostat and mirrors incl. mounting and approx. E 25 000 for the shaft with fire resistant glazing, the systems must only be considered for buildings where the improvement of lighting conditions can afford this investment.
- Local regulations, for example maximum building heights and other issues in urban city planning must be must considered during the planning phase.
- During the design process it is very important to be aware of the fire design regulations to be followed since both translucent and transparent glazing with high fire-resistance can be a substantial cost of the whole system. Cheaper solutions could be established having the vertical of sunlight outside the building (no shaft needed) and directing the sunlight horizontally into the depth of the building.

Annex

A.1 Task 20: Solar Energy in Building Renovation

In Subtask A, **Evaluation of Existing Building Applications**, the participants described and evaluated 15 existing solar renovation projects in six countries. The majority of these projects involved the multifamily building applications. Experiences concerning the different aspects of renovation, such as the various solar features employed, the renovation process itself, and occupant reactions were summarised in a working document, that was completed in October 1994.

In Subtask B, **Development of Improved/Advanced Renovation Concepts**, the participants developed an overview of many solar renovation possibilities, including strategies for heating, cooling and daylighting with different elements and for different types of buildings. The most interesting concepts were further analysed and computer simulations were completed for many systems. The market conditions for the different concepts were also investigated. A technical report was printed in January 1997.

In Subtask C, **Design of Solar Renovation Projects**, a common framework for reporting and evaluating design of solar renovation projects was developed and 16 projects from seven countries were reported. Experts examined the design process and the system concepts. The technical report was ready in July 1998.

Subtask D, **Documentation and Dissemination**, activities were devoted to synthesising and documenting information obtained from the other Subtasks. Four brochures were produced for different audiences. One overview brochure to catch the interest of solar renovation and three more technical brochures on different concepts: *Solar Collectors in Building Renovation*, *Glazed Balconies in Building Renovation* and *Transparent Insulation in Building Renovation*. The Experts also actively reported on solar energy in building renovation and the Task 20 work at international and national conferences, symposia and workshops.

In Subtask E, **Evaluation of Demonstration Projects**, an evaluation of the monitoring of seven of the demonstration projects from Subtask C was completed. Additional seven new projects were also included in this evaluation. Comparisons of the results from the projects were made for the different solar renovation technologies both according to energy performance and costs. Other aspects such as reasons for renovation, added value, lessons-learned, conclusions and recommendations were included in the analysis. The results will be published in a brochure, *Solar Renovation Demonstration Projects – Results and Experience*, in the same series as the brochures from Subtask D.

In Subtask F, **Improvement of Solar Renovation Concepts and Systems**, new and innovative solar renovation concepts are developed. Thirteen concepts are described, modelled, and the performance simulated. The report includes summaries and comparisons from all concepts together with summary, results conclusions and recommendations. All the concepts are described in detail.

Subtask G, **Dissemination of Results**, will organise the publishing of the Subtask E brochure. A slide set on CD-ROM will also be available. This CD-ROM represents a variety of the projects and concepts studied in Task 20. The national and international dissemination will be reported in a Dissemination Management Report within this Subtask.

A.2 Task 20 Participants

Operating Agent
Arne Elmroth
Lund University
Dept. of Building Physics
P.O. Box 118
S-22100 Lund, Sweden

Denmark
Olaf Bruun Jorgensen
Esbensen Consulting Engineers Ltd.
Vesterbrogade 124 B
DK-1620 Copenhagen

Germany
Karsten Voss
Fraunhofer Institute for Solar Energy Systems
Oltmannsstrasse 5
D-79100 Freiburg

Netherlands
Chiel Boonstra
W/E Consultants Sustainable Building
P. O. Box 733
NL-2800 AS Gouda

Sweden
Jan-Olof Olsson
Building Services Engineering
Chalmers University of Technology
S-412 96 Goteborg

Operating Agent Assistant
Elisabeth Kjellsson
Lund University
Dept. of Building Physics
P.O. Box 118
S-22100 Lund, Sweden

Switzerland
Andreas Haller
Ernst Schweizer AG
Metallbau
CH-8908 Hedingen

United States
Robert T. Lorand
Science Applications International Corp.
MS 2-7-2
Goodridge Drive 1710
McLean, Virginia 22102

Sheila Hayter
NREL
Center for Buildings & Thermal Systems
1617 Cole Boulevard
Golden, Colorado 80401-3393

A.3 IEA Solar Heating and Cooling Programme

The International Energy Agency (IEA) was established in 1974 as an autonomous agency within the framework of the Economic Cooperation and Development (OECD) to carry out a comprehensive program of energy cooperation among its 24 member countries and the Commission of the European Communities.

An important part of the Agency's program involves collaboration in the research, development and demonstration of new energy technologies to reduce excessive reliance on imported oil, increase long-term energy security and reduce greenhouse gas emissions. The IEA's R&D activities are headed by the Committee on Energy Research and Technology (CERT) and supported by a small Secretariat staff, headquartered in Paris. In addition, three Working Parties are charged with monitoring the various collaborative energy agreements, identifying new areas for cooperation and advising the CERT on policy matters.

Collaborative programs in the various energy technology areas are conducted under Implementing Agreements, which are signed by contracting parties (government agencies or entities designated by them). There are currently 40 Implementing Agreements covering fossil fuel technologies, renewable energy technologies, efficient energy end-use technologies, nuclear fusion science and technology, and energy technology information centers.

The Solar Heating and Cooling Programme was one of the first IEA Implementing Agreements to be established. Since 1977, its 20 members have been collaborating to advance active solar, passive solar and photovoltaic technologies and their application in buildings.

Australia	Finland	Norway
Austria	France	Spain
Belgium	Italy	Sweden
Canada	Japan	Switzerland
Denmark	Mexico	United Kingdom
European Commission	Netherlands	United States
Germany	New Zealand	

A total of 26 Tasks have been initiated, 19 of which have been completed. Each Task is managed by an Operating Agent from one of the participating countries. Overall control of the program rests with an Executive Committee comprised of one representative from each contracting party to the Implementing Agreement. In addition, a number of special ad hoc activities--working groups, conferences and workshops--have been organized.

The Tasks of the IEA Solar Heating and Cooling Programme, both completed and current, are as follows:

Completed Tasks:

Task 1	<i>Investigation of the Performance of Solar Heating and Cooling Systems</i>
Task 2	<i>Coordination of Solar Heating and Cooling R&D</i>
Task 3	<i>Performance Testing of Solar Collectors</i>
Task 4	<i>Development of an Insolation Handbook and Instrument Package</i>
Task 5	<i>Use of Existing Meteorological Information for Solar Energy Application</i>
Task 6	<i>Performance of Solar Systems Using Evacuated Collectors</i>
Task 7	<i>Central Solar Heating Plants with Seasonal Storage</i>
Task 8	<i>Passive and Hybrid Solar Low Energy Buildings</i>
Task 9	<i>Solar Radiation and Pyranometry Studies</i>
Task 10	<i>Solar Materials R&D</i>
Task 11	<i>Passive and Hybrid Solar Commercial Buildings</i>
Task 12	<i>Building Energy Analysis and Design Tools for Solar Applications</i>
Task 13	<i>Advance Solar Low Energy Buildings</i>
Task 14	<i>Advance Active Solar Energy Systems</i>
Task 16	<i>Photovoltaics in Buildings</i>
Task 17	<i>Measuring and Modeling Spectral Radiation</i>
Task 18	<i>Advanced Glazing and Associated Materials for Solar and Building Applications</i>
Task 19	<i>Solar Air Systems</i>
Task 20	<i>Solar Energy in Building Renovation</i>

Current Tasks and Working Groups:

Task 21	<i>Daylight in Buildings</i>
Task 22	<i>Building Energy Analysis Tools</i>
Task 23	<i>Optimization of Solar Energy Use in Large Buildings</i>
Task 24	<i>Solar Procurement</i>
Task 25	<i>Solar Assisted Air Conditioning of Buildings</i>
Task 26	<i>Solar Combisystems</i>
Working Group	<i>Materials in Solar Thermal Collectors</i>
Working Group	<i>Evaluation of Task 13 Houses</i>

To receive a publications catalogue or learn more about the IEA Solar Heating and Cooling Programme visit our Internet site at <http://www.iea-shc.org> or contact the SHC Executive Secretary, Pamela Murphy Kunz, Morse Associates Inc., 1808 Corcoran Street, NW, Washington, DC 20009, USA, Telephone: +1/202/483-2393, Fax: +1/202/265-2248, E-mail: pmurphykunz@compuserve.com.