

# UMH latest developments

**Pedro Vicente Quiles**

Universidad Miguel Hernández de Elche

[pedro.vicente@umh.es](mailto:pedro.vicente@umh.es)

<http://dime.umh.e>





**PV + HP FOR DOMESTIC HOT WATER**

**PV + HP FOR SPACE HEATING AND COOLING**



# BOILER + SOLAR THERMAL vs. HEAT PUMP + PV

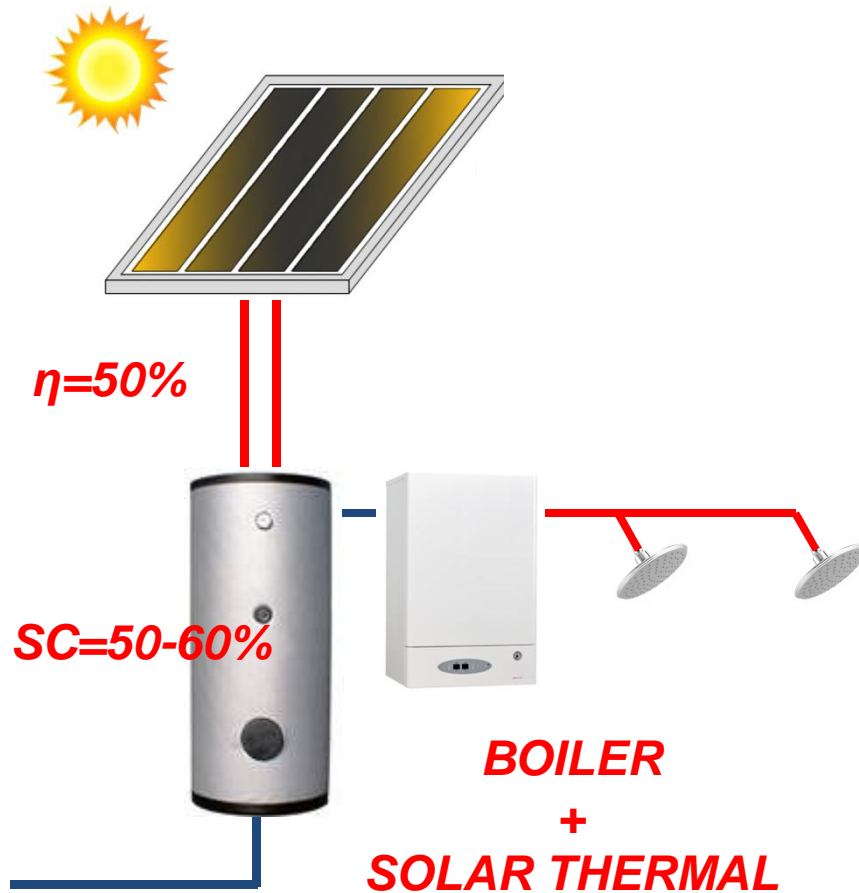

vs.

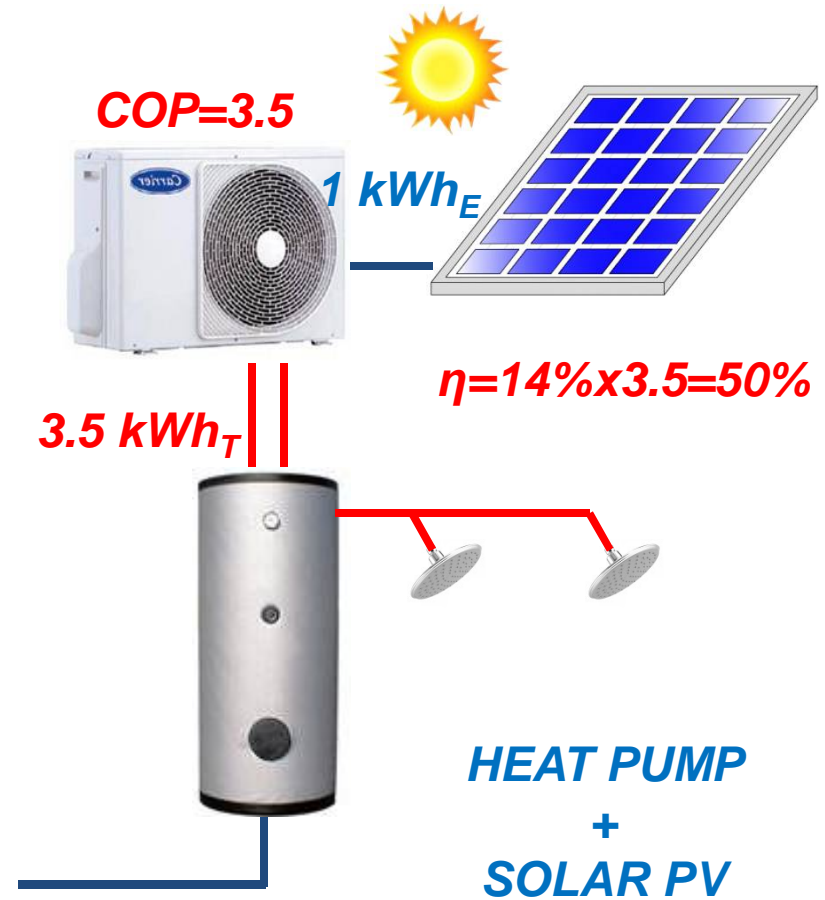



## EXPERIMENTAL RESULTS ON HEAT PUMP + PV

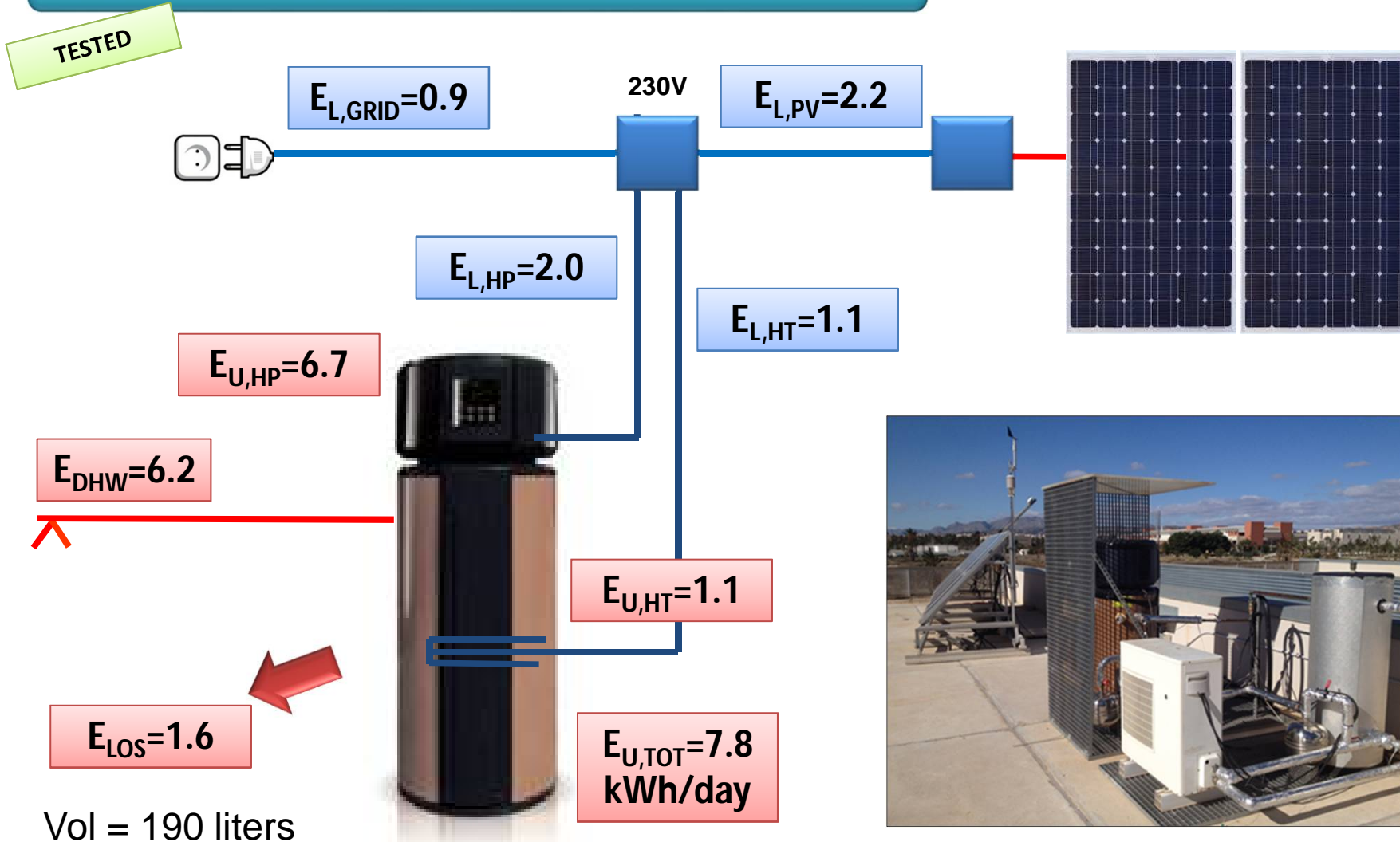



## EXPERIMENTAL RESULTS ON HEAT PUMP + PV

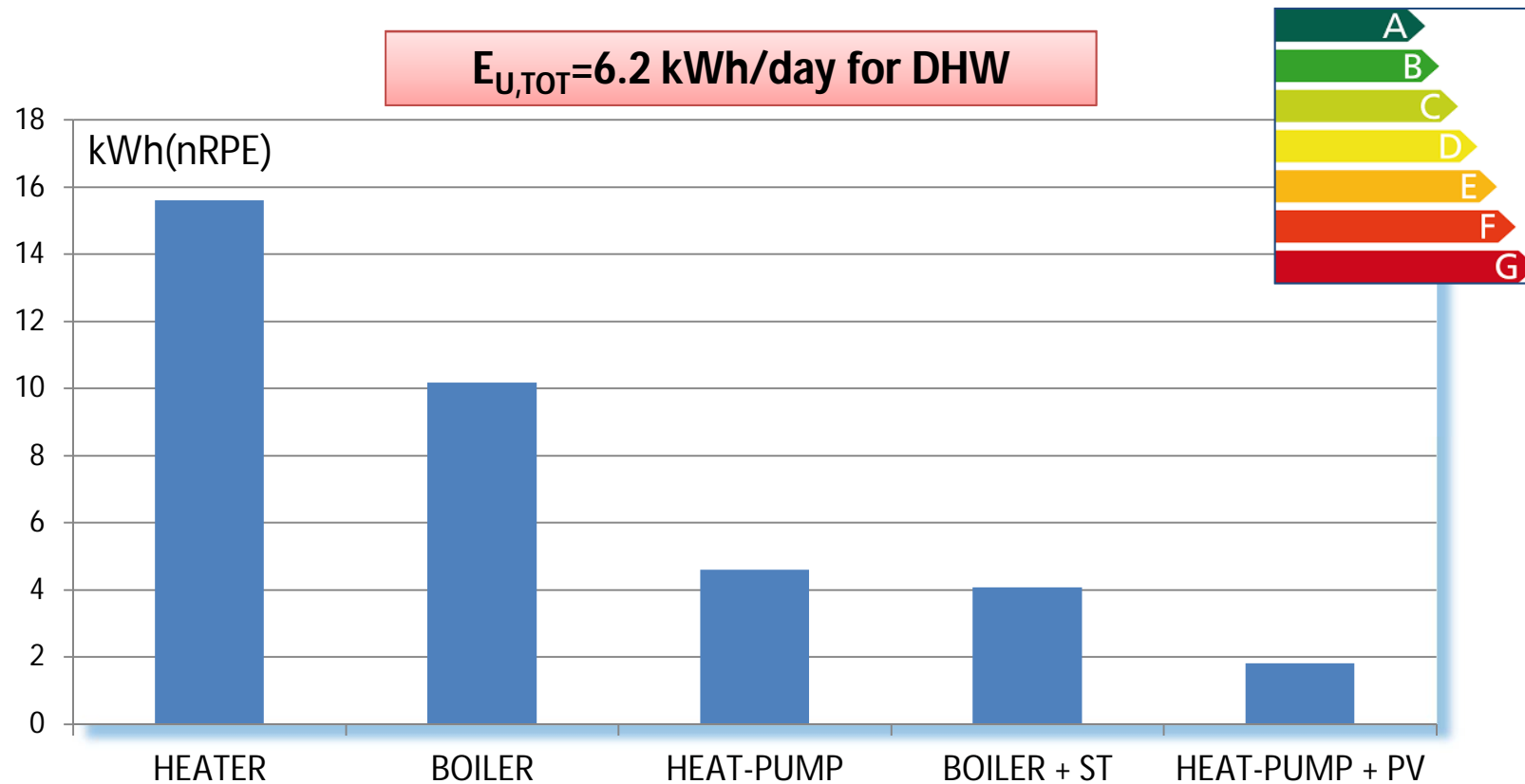



# EXPERIMENTAL RESULTS ON HEAT PUMP + PV

RUNNING IN A  
REAL HOUSE  
SINCE SEP2017

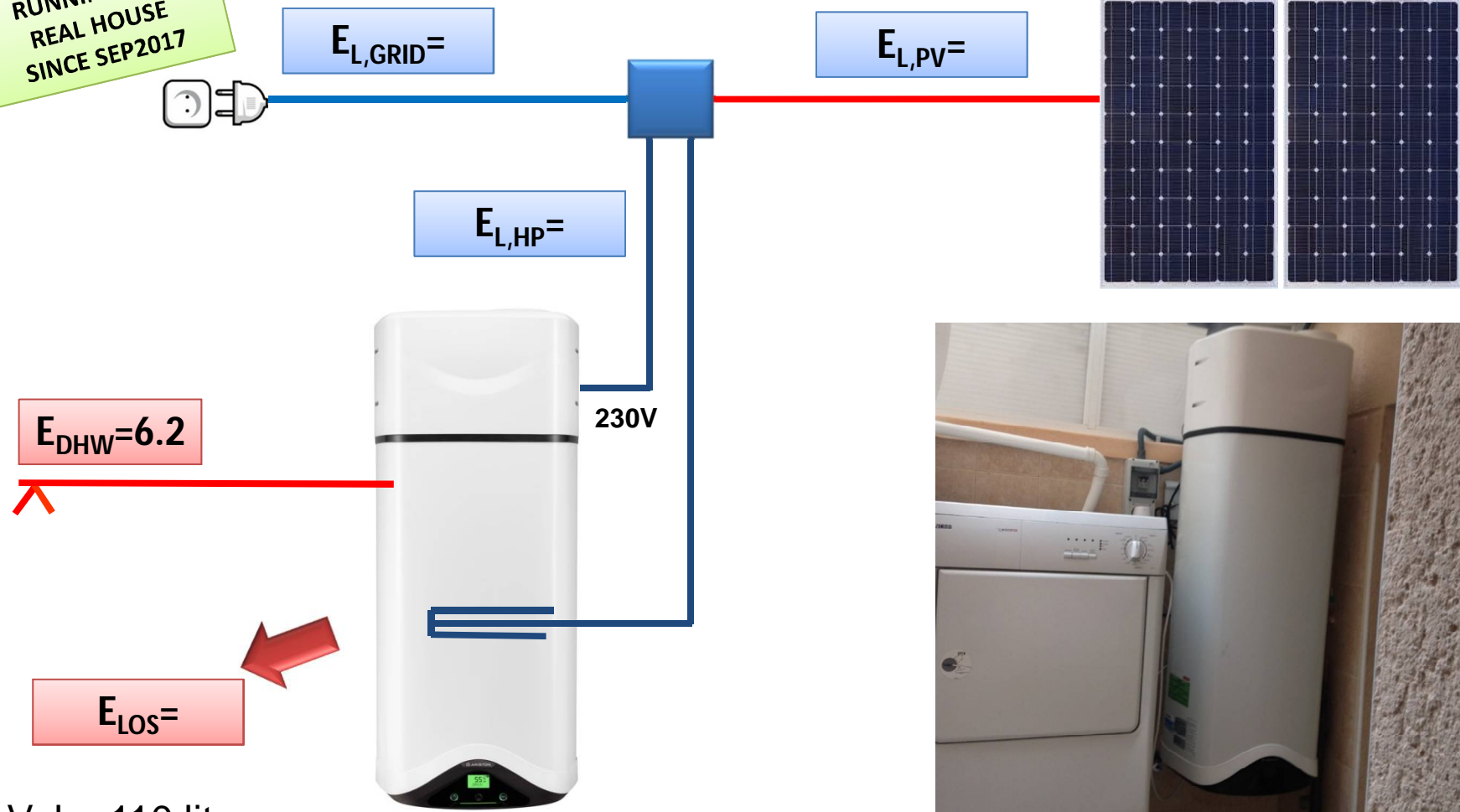

Vol = 110 liters  
HP: 250 W



# EXPERIMENTAL RESULTS ON HEAT PUMP + PV

**RUNNING IN A  
REAL HOUSE  
SINCE SEP2017**

Detalle / **miércoles, 4. abril 2018** /



Vol = 110 liters  
HP: 250 W

SC%?  
PF?  
PE\_SAV?

**CONFORT?**



Detalle / **miércoles, 4. abril 2018** /

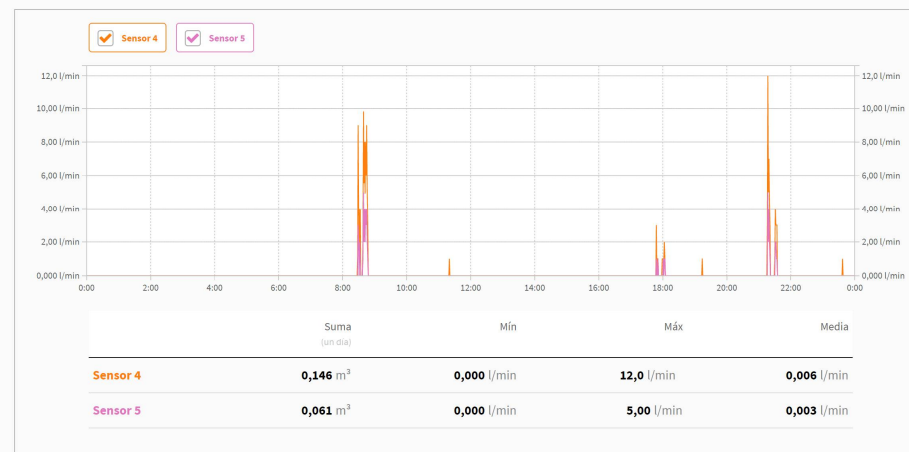



# EXPERIMENTAL RESULTS ON HEAT PUMP + PV

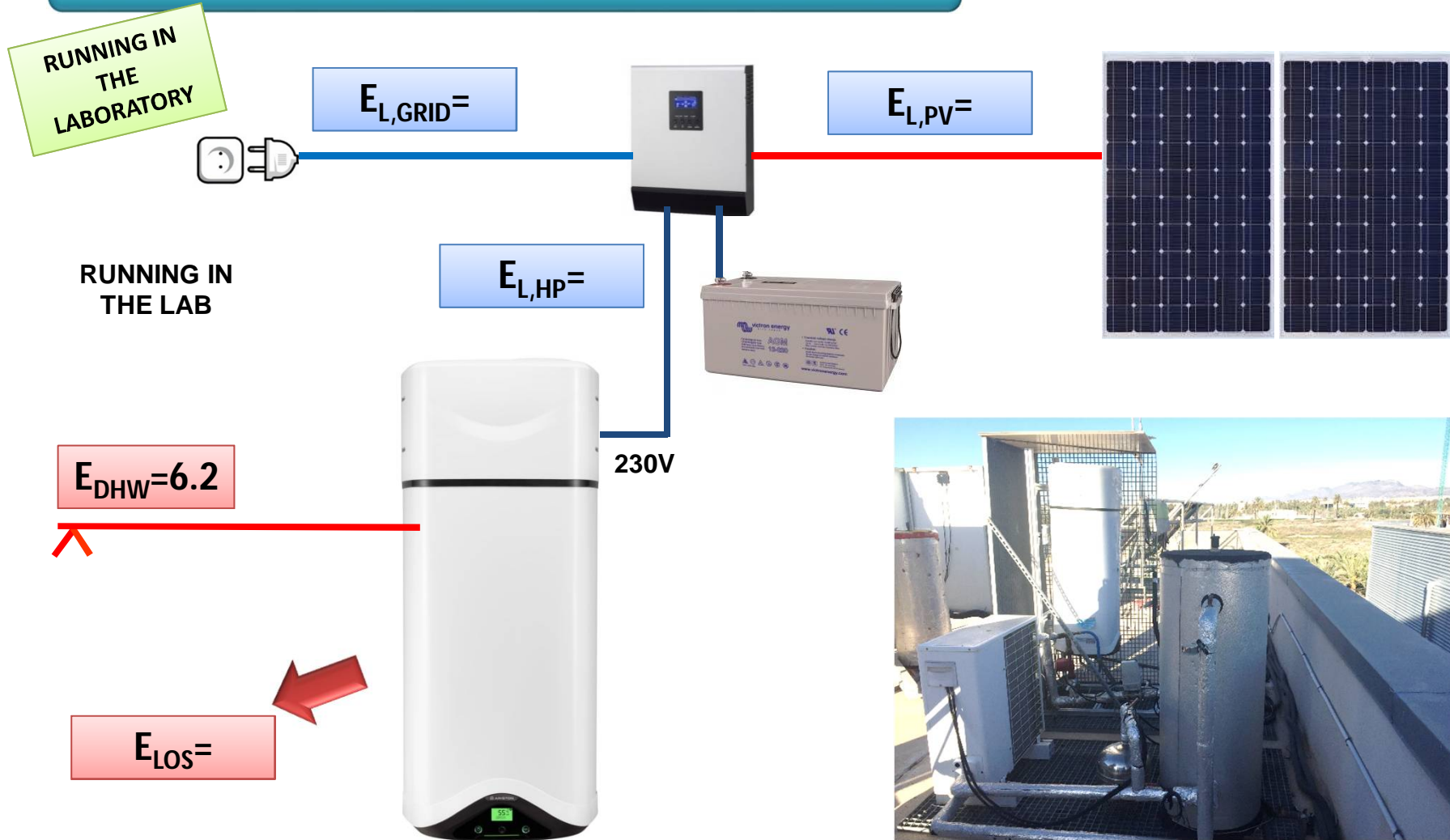



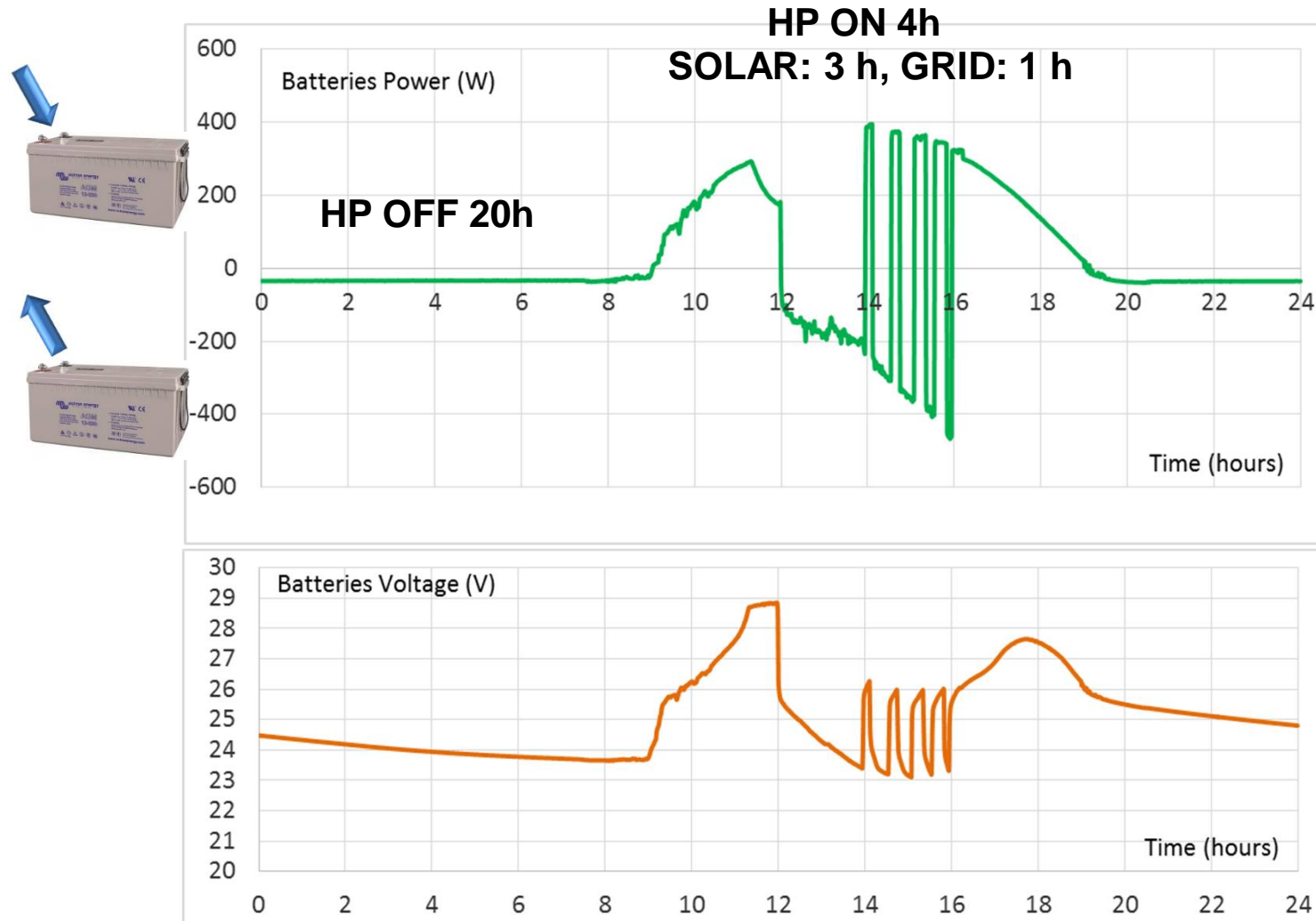



# EXPERIMENTAL RESULTS ON HEAT PUMP + PV

OCTOBER  
2018

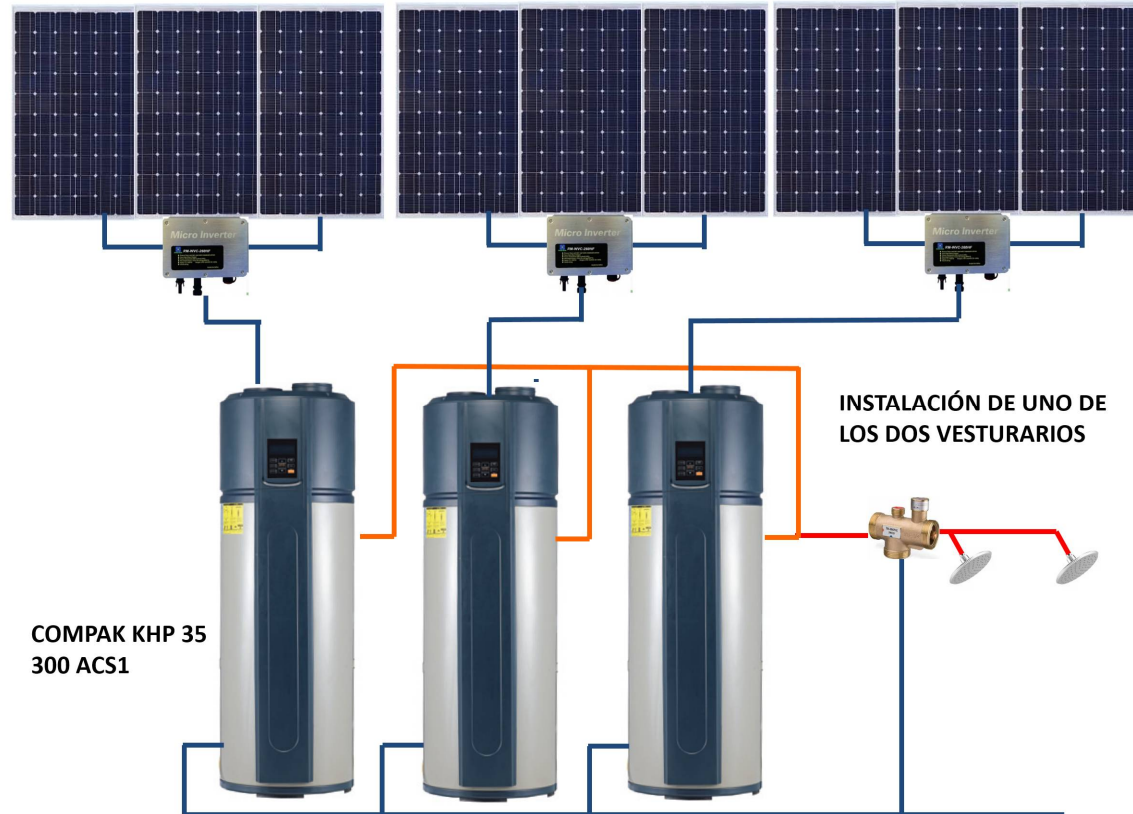

COMPAK KHP 35  
300 ACS1

INSTALACIÓN DE UNO DE  
LOS DOS VESTURARIOS



# EXPERIMENTAL RESULTS ON HEAT PUMP + PV

JANUARY  
2018





# EXPERIMENTAL RESULTS ON HEAT PUMP + PV

JANUARY  
2018

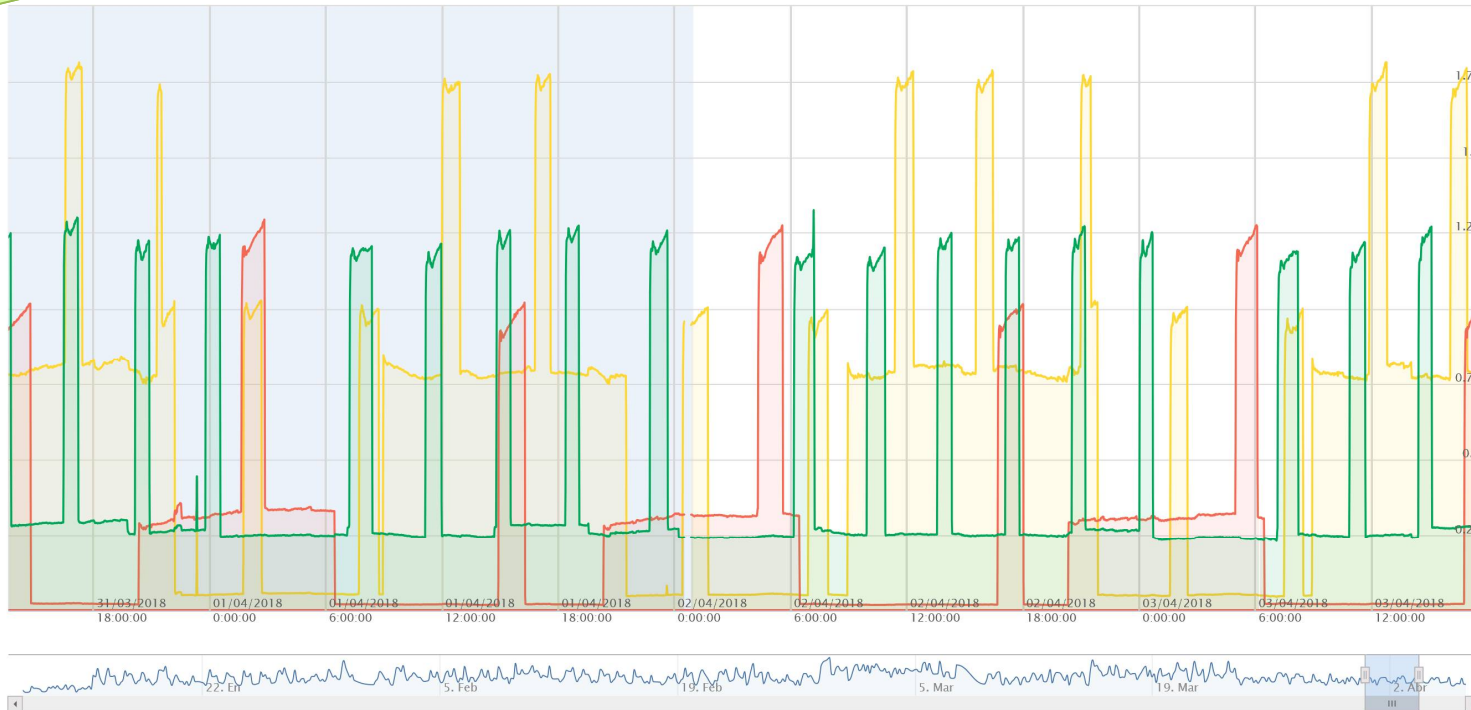



# MODELING THERMAL STORAGE FOR DHW

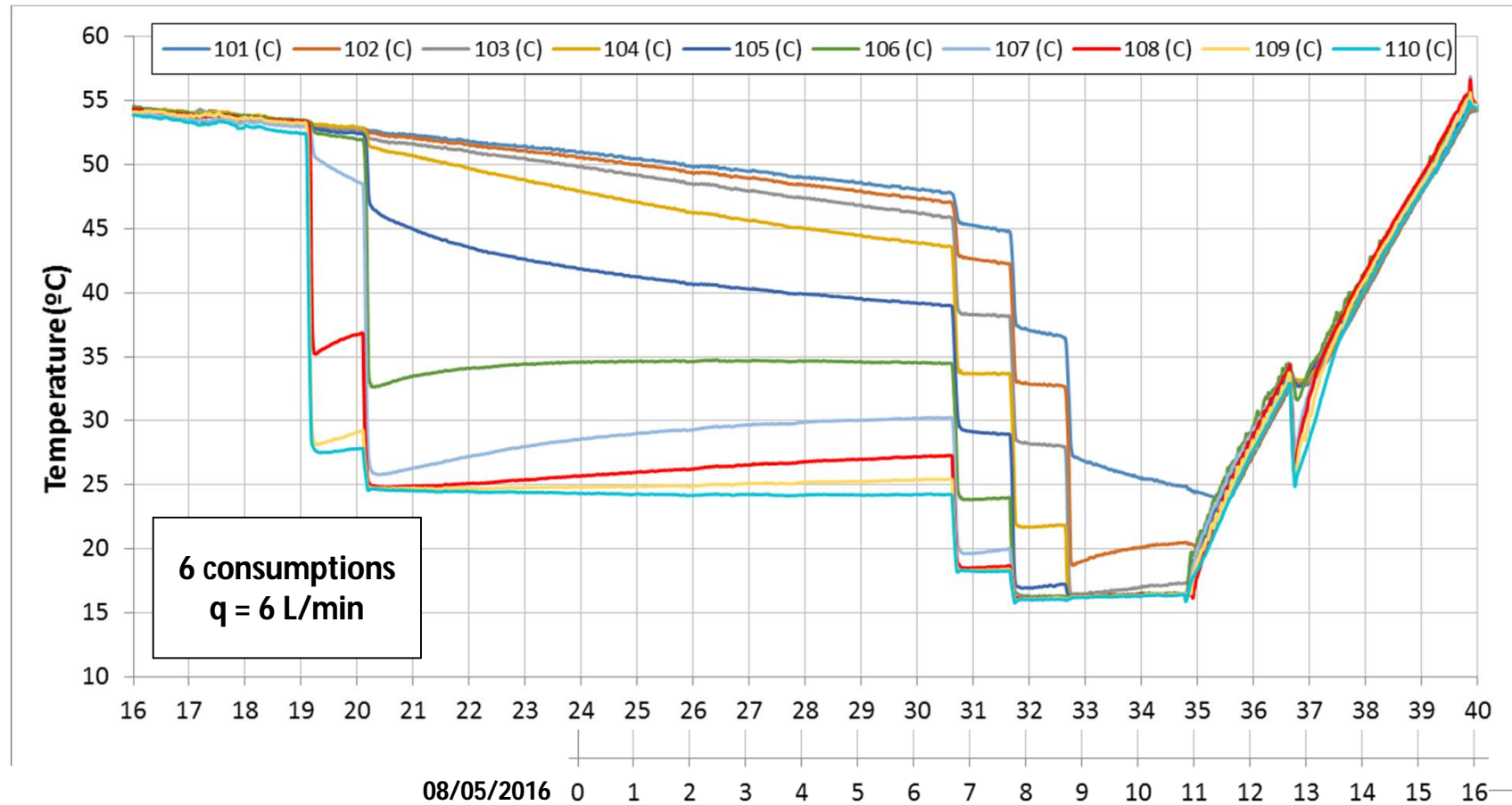



# MODELING THERMAL STORAGE FOR DHW

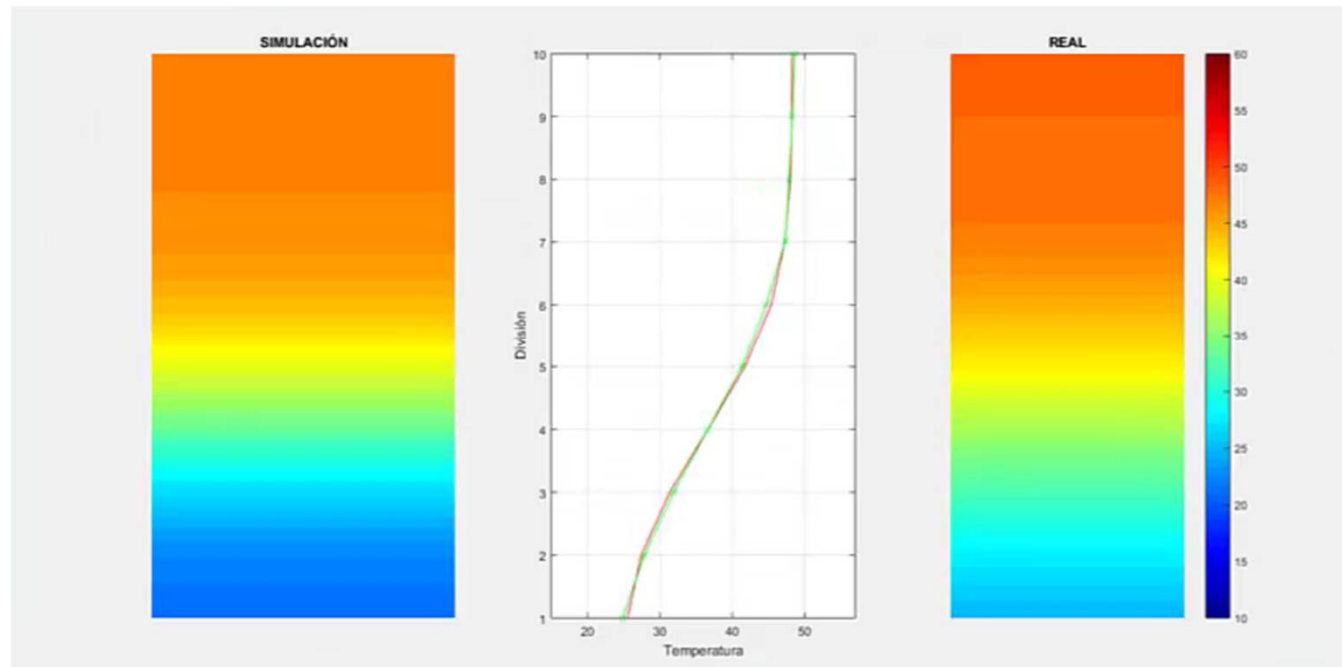



**PV + HP FOR SPACE HEATING AND COOLING**





## PV + HP FOR SPACE HEATING AND COOLING





# PV + HP FOR SPACE HEATING AND COOLING

## EVAP4COOLING

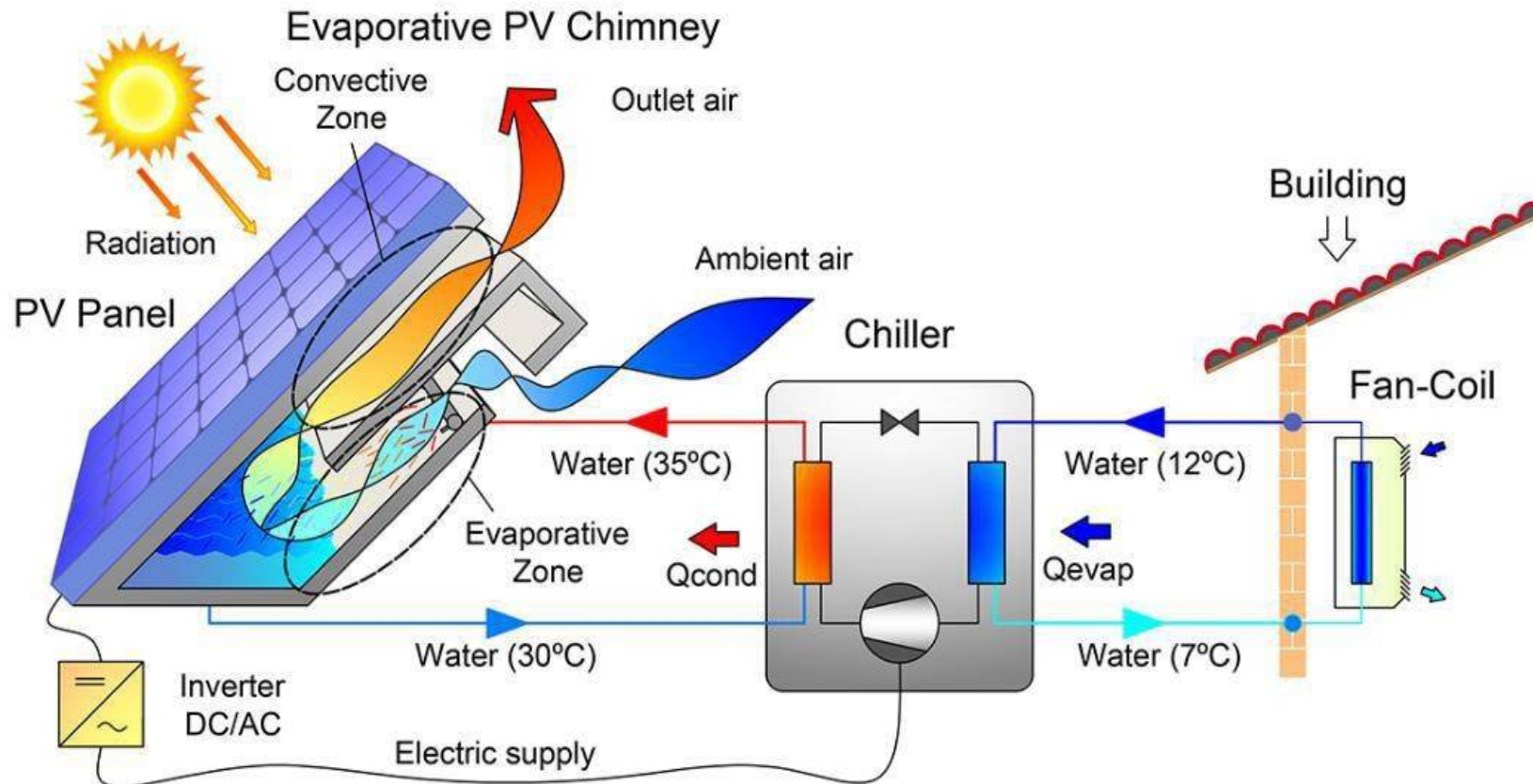



# PV + HP FOR SPACE HEATING AND COOLING

## EVAP4COOLING

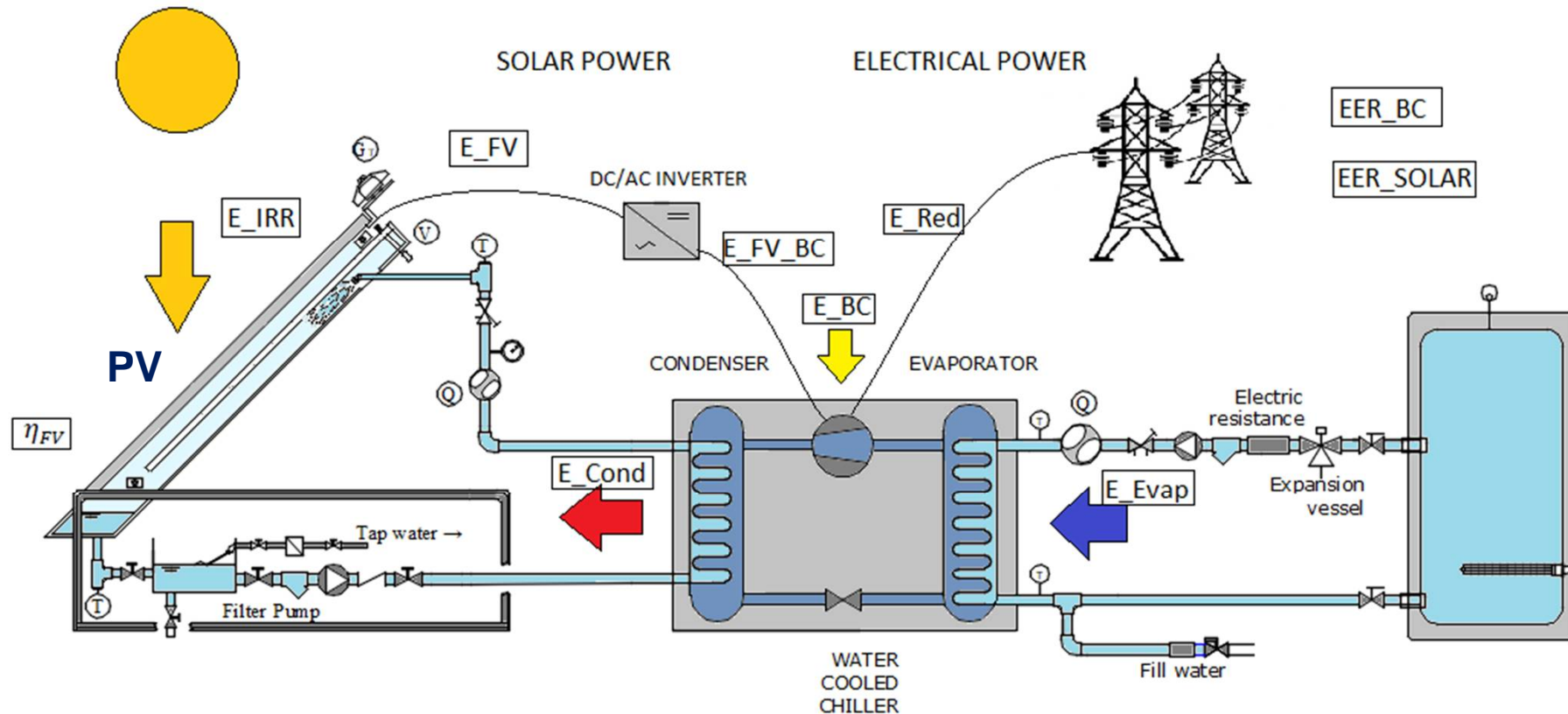



## PV + HP FOR SPACE HEATING AND COOLING

### EVAP4COOLING







# PV + HP FOR SPACE HEATING AND COOLING

## EVAP4COOLING

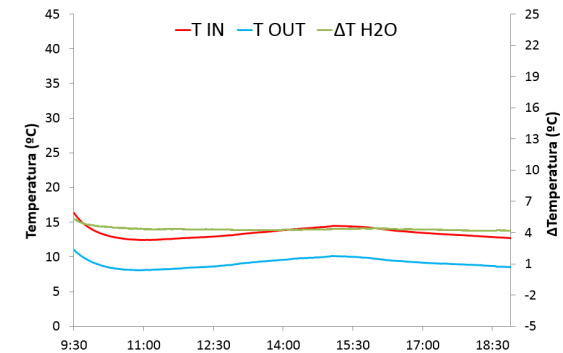
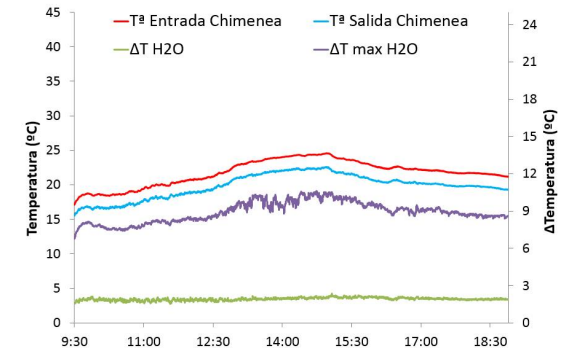
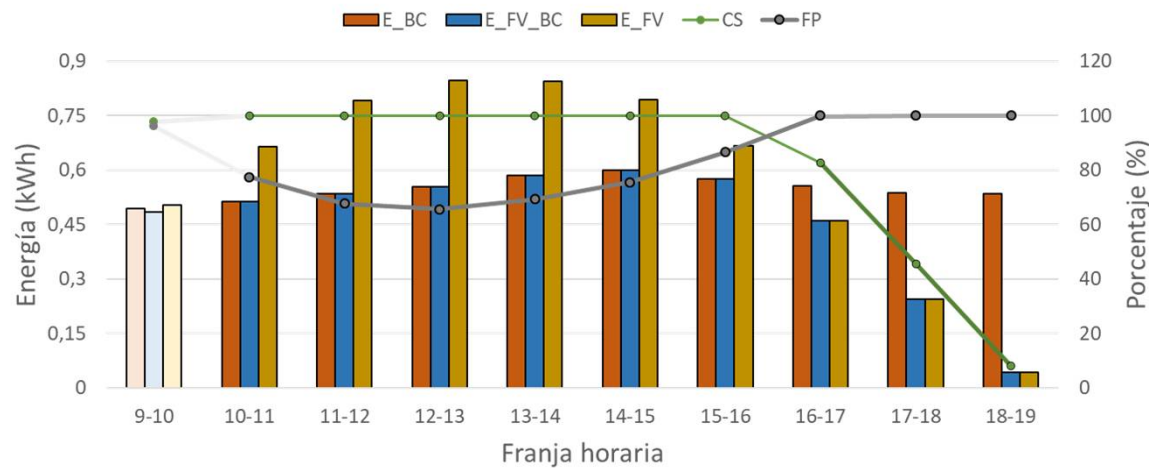

$$FP = \frac{E_{FVBC}}{E_{FV}}$$

$$CS = \frac{E_{FVBC}}{E_{BC}}$$



# PV + HP FOR SPACE HEATING AND COOLING

JUNE  
2018

## NEW NATIONAL RESEARCH PROJECT

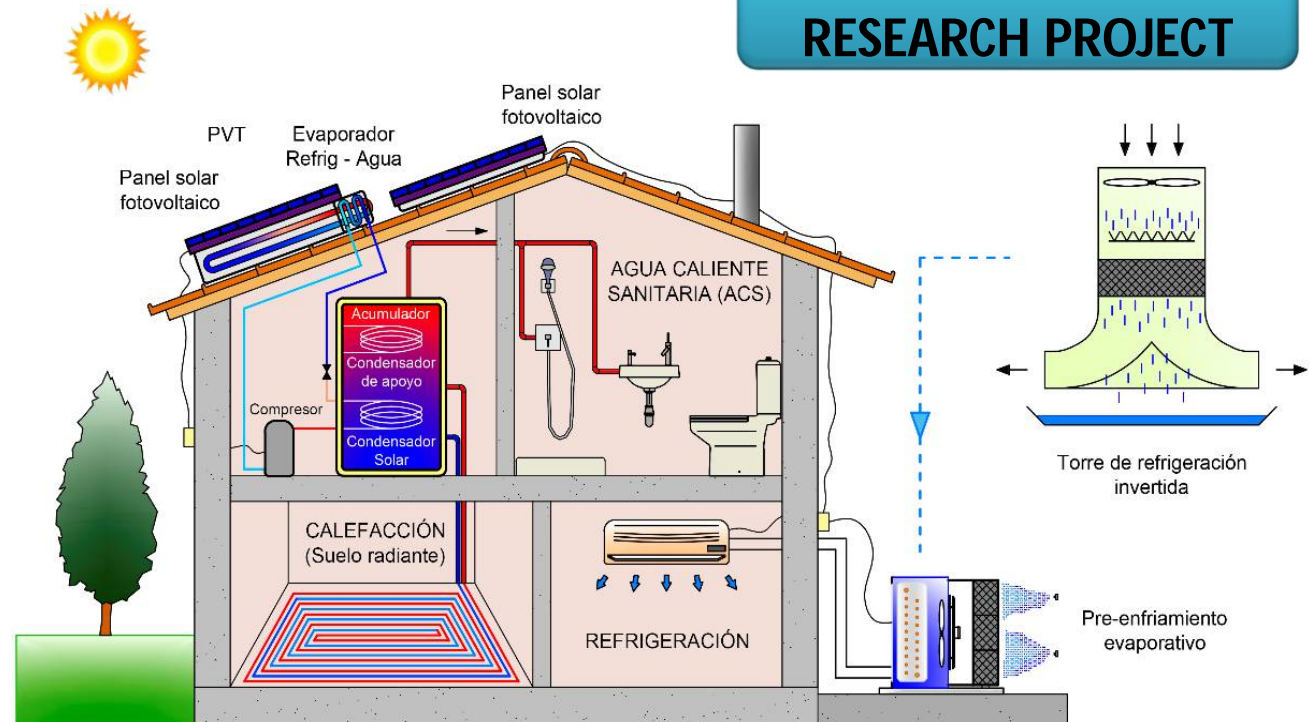

# UMH latest developments

**Pedro Vicente Quiles**

Universidad Miguel Hernández de Elche

[pedro.vicente@umh.es](mailto:pedro.vicente@umh.es)

<http://dime.umh.e>

