

PASSIVE AND HYBRID SOLAR LOW ENERGY BUILDINGS

# DESIGN TOOL SELECTION AND USE

# 4

DESIGN INFORMATION BOOKLET NUMBER FOUR

DECEMBER 1988

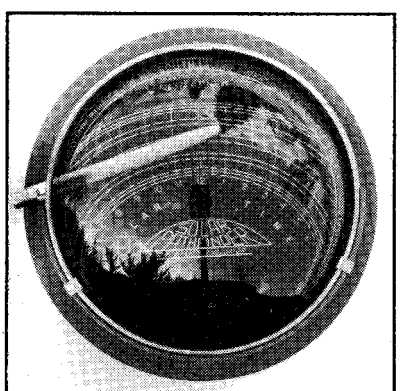
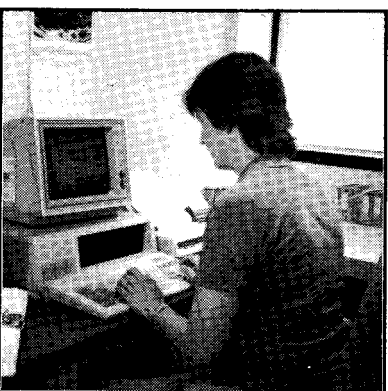
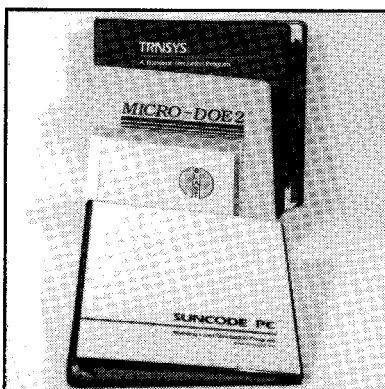
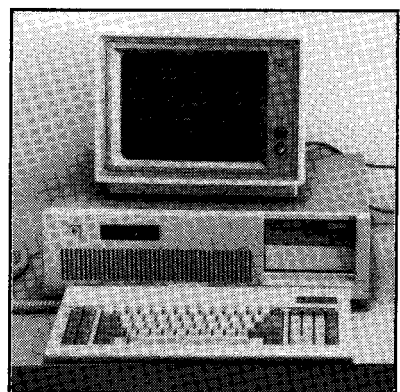
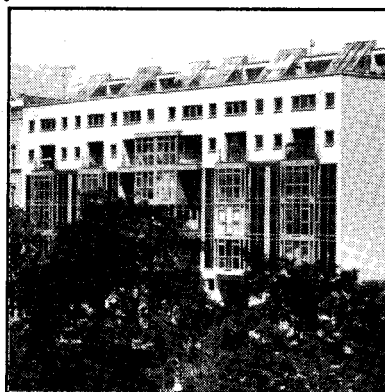
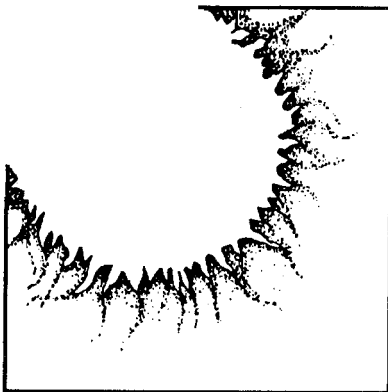

**NOTICE:**

This report was prepared as an account of work sponsored by the U.S. Department of Energy under Contract No. DE-AC03-87SF16667 for the International Energy Agency. Neither the U.S. Government nor the International Energy Agency, nor any of their employees, nor any of their contractors, subcontractors, or their employees makes any warranty, expressed or implied, or assumes any legal liability or responsibility for the accuracy, completeness or usefulness of any information, apparatus, product or process disclosed, or represents that its use would not infringe privately owned rights.

REPORT NO. IEA SHAC T.8.C.4

PASSIVE AND HYBRID SOLAR LOW ENERGY BUILDINGS

# DESIGN TOOL SELECTION AND USE

# 4

DESIGN INFORMATION BOOKLET NUMBER FOUR

DECEMBER 1988

Donald L. Anderson  
Burt Hill Kosar Rittelmann Associates  
Butler, Pennsylvania

Sheila Blum  
International Planning Associates, Inc.  
Beltsville, Maryland

Michael J. Holtz  
Architectural Energy Corporation  
Boulder, Colorado

INTERNATIONAL ENERGY AGENCY: SOLAR HEATING AND COOLING PROGRAM, TASK VIII

# FOREWORD

---

The International Energy Agency (IEA), headquartered in Paris, France, was formed in November 1974 to establish cooperation among a number of industrialized countries in the vital area of energy policy. It is an autonomous body within the framework of the Organization for Economic Cooperation and Development. Twenty-one countries are presently members, with the Commission of the European Communities participating under a special arrangement.

One element of the IEA's program involves cooperation in the research and development of alternative energy resources in order to reduce excessive dependence on oil. A number of new and improved energy technologies that have the potential of making significant contributions to global energy needs were identified for collaborative efforts. Solar heating and cooling was one of the technologies selected for joint activities. Cooperative research is conducted under terms of a formal Implementing Agreement signed by the participating countries. One of the collaborative projects, Task VIII, concerns passive and hybrid solar, low energy buildings.

The goal of Task VIII is to accelerate the technical understanding and marketplace availability of energy efficient, passive solar homes. Fourteen countries have participated in the research - Austria, Belgium, Canada, Denmark, Federal Republic of Germany, Italy, Netherlands, New Zealand, Norway, Spain, Switzerland, Sweden, United Kingdom and United States.

The knowledge gained during this collaboration has been assembled in a series of eight booklets. The Design Information Booklets in the series are listed and described on the opposite page. Information on purchasing these booklets can be obtained by contacting the following organizations:

## **Austria**

Osterreichisches  
Forschungszentrum Seibersdorf  
A - 2444 Seibersdorf

## **Germany**

Projektleitung Biologie, Ökologie  
und Energie  
KFA Jülich  
Postfach 1913  
D - 5170 Jülich

## **Norway**

A/S Miljøplan  
Kjørboveien 23  
N - 1300 Sandvika

## **United Kingdom**

Renewable Energy Enquiries  
Bureau  
Energy Technology Support Unit  
Harwell Laboratory, Building 156  
Oxfordshire OX 11 0RA

## **Belgium**

Science Policy Office  
Rue de la Science 8  
B - 1040 Brussels

## **Italy**

Consiglio Nazionale Ricerche  
Progetto Finalizzato Energetica  
Via Nizza 128  
I - 00198 Roma

## **Spain**

IER - CIEMAT  
Avda Complutense 22  
28040 Madrid

## **United States**

Technical Inquiry Service  
Solar Energy Research Institute  
1617 Cole Boulevard  
Golden, Colorado 80401

## **Canada**

Solar Energy Development  
Program  
Energy, Mines and Resources  
460 O'Connor Street  
Ottawa, Ontario K1A 0E4

## **Netherlands**

Management Office for Energy  
Research (PEO)  
P.O. Box 8242  
NL - 3503 - RE Utrecht

## **Sweden**

Svensk Byggtjänst,  
Litteratutjänst  
Box 7853,  
103 99 Stockholm

## **Denmark**

Thermal Insulation Laboratory  
Technical University of Denmark  
Building 118  
DK - 2800 Lyngby

## **New Zealand**

School of Architecture  
Victoria University of Wellington  
Private Bag  
Wellington 1

## **Switzerland**

Federal Office of Energy  
CH - 3003 Berne

The U.S. Department of Energy (DOE) is the Operating Agent of IEA Task VIII: Passive and Hybrid Solar Low Energy Buildings. Michael J. Holtz of Architectural Energy Corporation, Boulder, Colorado, serves as Task Chairman on DOE's behalf.

# DESIGN INFORMATION BOOKLET SERIES

---

## **Booklet No. 1 Energy Design Principles In Buildings**

This Booklet is essentially a primer of heat transfer in buildings. Fundamental heat transfer concepts and terminology are defined, followed by a discussion of heating and cooling strategies and principles for passive and hybrid solar buildings. It is written in non-technical language for the designer or builder not familiar with general heat transfer principles in buildings.

## **Booklet No. 2 Design Context**

Booklet number 2 defines, in a checklist format, the issues that are unique to energy conserving, passive solar design that must be considered early in the design process. Issues discussed include site and climate analysis, building organization and design, building system options, space conditioning options, user influence and building codes and zoning ordinances.

## **Booklet No. 3 Design Guidelines: An International Summary**

Passive solar and energy conservation design guidelines have been developed by each participating country. These guidelines are presented in national design guidelines booklets. Booklet number 3, Design Guidelines: An International Summary, summarizes the major findings and patterns of performance observed from the national passive solar and energy conservation guidelines.

## **Booklet No. 4 Design Tool Selection And Use**

This Booklet addresses the characteristics desirable in a design tool and a means to select one or more for use. The selection process is organized around the design process; what design questions are being addressed, what information is available, what output or result from a design tool for which one is looking. A checklist is provided to assist in design tool selection. The use of benchmark test cases developed from detailed building energy analysis simulations is presented as a means to evaluate simplified design tools.

## **Booklet No. 5 Construction Issues**

Construction problems unique to the use of passive and hybrid solar features are defined in this booklet as well as several proven solutions. Due to the unique construction technology in each country, representative construction details are provided. The intent is to define where construction detailing is crucial to the performance of low energy, passive solar homes and provide some ideas on how these detailing problems can be solved for a range of construction technology.

## **Booklet No. 6 Passive Solar Homes: Case Studies**

This Booklet describes the passive and hybrid solar houses designed, constructed and monitored under the IEA Task VIII project, as a means of showing the architectural impact of energy conservation and passive/ hybrid solar features. This booklet reinforces the idea that good energy design is also good architecture and is cost effective. Each of the passive solar houses is presented as a case study on the design, construction and performance results.

## **Booklet No. 7 Design Language**

Booklet number 7 is aimed at designers, architects and educators. It defines an approach to generating whole building solutions based on climate analysis and design context analysis. It also addresses architectural typologies based on climatic/energy principles. This booklet forms a general, universal companion to Booklet Number 3, Design Guidelines.

## **Booklet No. 8 Post Construction Activities**

Post Construction Activities defines issues to be considered once the project is constructed and occupied. It addresses those elements of the passive solar building that are unique and may require special attention by the occupants. Performance evaluation of the home in terms of energy performance, comfort and occupant satisfaction is also addressed as a means of providing information back to the designer on how well the project is performing.

# **ACKNOWLEDGEMENTS**

---

The preparation of this document has been a collaboration between Mr. Donald Anderson of Burt Hill Kosar Rittelmann Associates, Ms. Sheila Blum of International Planning Associates, and Mr. Michael Holtz of Architectural Energy Corporation. The original draft was prepared by Mr. Anderson and subsequently modified and edited by Ms. Blum and Mr. Holtz. These individuals wish to acknowledge the helpful comments and suggestions provided by the Subtask C participants and the authors of other booklets in the Design Information Booklet series including Ms. Anne Minne, Mr. Gunter Lohnert, Mr. Hans Kok, Mr. Sergio Los and Mr. Ron Brewer. Also, the authors wish to acknowledge the assistance of Chris Mack and Jerri Turner of Architectural Energy Corporation in preparing the graphic figures and camera-ready copy.

The support of the U.S. Department of Energy Solar Building Program is gratefully acknowledged, especially that of Dr. Frederick Morse, Ms. Mary Margaret Jenior, Mr. Robert Hughey, and Mr. Michael Lopez.

# CONTENTS

---

	Page No.
1.0 INTRODUCTION . . . . .	1
2.0 ENERGY DESIGN TOOLS . . . . .	3
2.1 What is a Design Tool ? . . . . .	3
2.2 Categories of Design Tools . . . . .	3
2.3 Why Use Design Tools ? . . . . .	5
2.4 Design Tool Accuracy . . . . .	5
3.0 DESIGN TOOLS IN THE DESIGN PROCESS . . . . .	7
3.1 The Design Process . . . . .	7
3.2 The Pre-Design Phase . . . . .	8
3.3 The Schematic Design Phase . . . . .	13
3.4 Design Development Phase . . . . .	15
3.5 Construction Documents and Construction Observation . . . . .	16
4.0 DESIGN TOOL SELECTION . . . . .	17
4.1 Basic Selection Criteria . . . . .	17
4.2 Assessing a Design Tool's Key Characteristics . . . . .	18
4.3 Comparison Shopping . . . . .	21
4.4 Choosing a Design Tool: A Basic Checklist . . . . .	22
5.0 CONCLUSIONS . . . . .	27
6.0 REFERENCES . . . . .	28
APPENDIX A: National Design Tools . . . . .	29
APPENDIX B: Design Tool Selection Checklist . . . . .	39

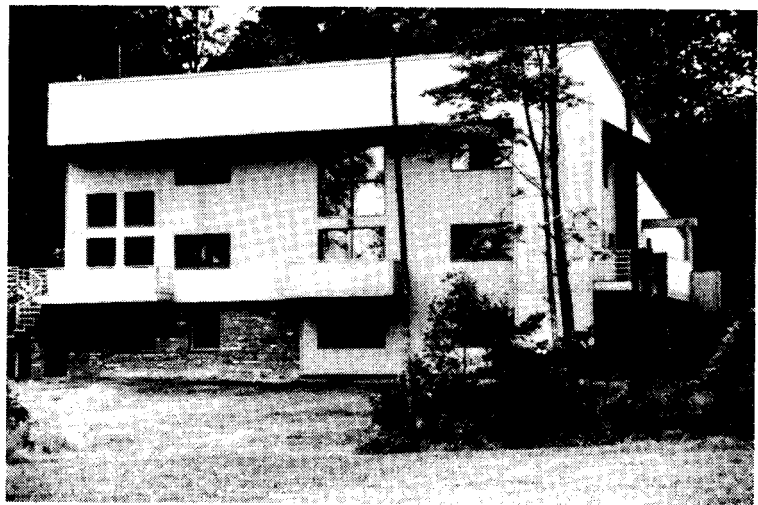

1.1: Passive Solar Home, Oakton, Virginia, USA



**Design Tool Selection and Use** is concerned with building energy design tools: how they are used in the design of passive solar residential buildings, and how to select an appropriate tool.

During the past few years, the number of energy design tools has risen dramatically, giving building designers a better chance of finding the right tool for their particular needs. As the options grow more numerous and more sophisticated, however, the potential design tool buyer's decision becomes more complicated. Comparison among different tools is sometimes difficult, and many of the factors that affect a design tool's usefulness are not immediately apparent to a first-time buyer.

The purpose of this booklet is to give the building designer a framework for selecting energy design tools. In that selection process, the questions that potential tool users ask vendors about design tools are important; equally important are the questions tool users should ask themselves about their needs and expectations regarding design tools.

This booklet focuses on three topics:

BOOKLET TOPICS

- How design tools can assist decision-making at each phase in the design process;
- How design tool users can evaluate their specific needs and which design tool (or tools) can best meet those needs; and
- How design tool users can effectively "shop" for design tools by comparing the characteristics of various tools and asking the right questions to make an informed choice.



1.2: Example Design Tool

Although aimed primarily at those who are beginning to consider how energy design tools might fit into their current practice, the information in this booklet should also be useful to designers who are already using energy design tools, by suggesting additional ways to apply the tool's capabilities to design problems.

The Appendix contains a list of some of the major design tools used in each IEA Task VIII member country. This listing should not be construed as an endorsement or recommendation of any of these tools; likewise there may be tools of equal or better quality which were not included in the listing. The state of design tool development is very dynamic. Tools are often updated and improved or surpassed by newer tools with better features. The listing is only meant to be representative of available tools and to serve as a starting point in the design tool selection process.



1.3: Passive Solar Home, Sevilla, Spain

An energy design tool is defined as any method or device specifically created to aid in the design of energy-efficient buildings. Many different kinds of design tools fall within this broad definition, including, for example, engineering tools which are used to size heating, cooling and ventilation equipment. For the purposes of this booklet the term "design tool" will be used to refer to tools that help make design decisions which affect energy use, and, in particular, tools which are used in the design of passive solar residential buildings.

Currently-available design tools fall into five broad categories:

### Physical Modeling and Graphic Devices.

Used primarily for site analysis to assess solar access and site shading, this category includes design tools for graphically plotting the sunpath at different times during the year vis-a-vis objects on the site or on adjacent sites (Figure 2.1).

The input into design tools in this category usually consists of values (either directly observed or chosen from a reference table) which are plotted by hand onto a diagram or chart. The output is generally a graphic representation of the shading patterns on the site during various times of the day and year.

**Design Guidelines.** This category includes quantitative and qualitative rules-of-thumb and similar sources of design guidelines. Although some are quite general, the most useful design guidelines are based on local climate data, and give specific recommendations for such features as insulation levels and the sizing of glazing and thermal mass.

Generally speaking, design guidelines can be said to provide a starting point for an energy-efficient passive solar design. This is important since, as will be discussed later, many of the decisions which have the strongest influence over energy use are made early in the design process. If the recommendations in design guidelines are followed, the designer can then be reasonably assured that whatever shape the design ultimately takes, an acceptable level of energy performance can be expected.

**Handbooks.** Design manuals and handbooks generally contain recommended procedures for designing energy-efficient passive solar homes. Manual calculation procedures are usually provided for determining the energy and economic performance of different energy saving strategies. Nomographs and the psychrometric chart also come under this category of design tool.

The input required to use these manual calculation procedures generally includes a building description, climate data, energy design data and, if required, economic data. The results are usually presented as monthly, seasonal or annual heating and cooling loads, consumption and costs.

## 2.1 WHAT IS A DESIGN TOOL?

## 2.2 CATEGORIES OF DESIGN TOOLS

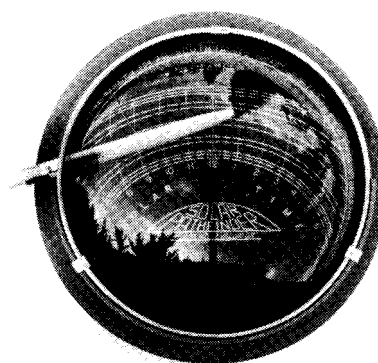

2.1: Sunpath Plotter

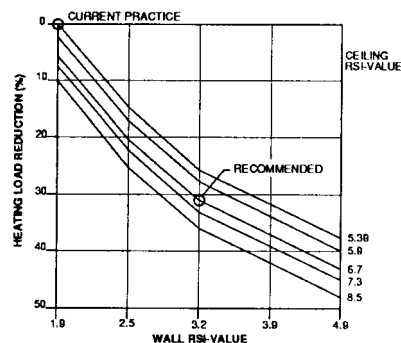

2.2: Example Design Guideline

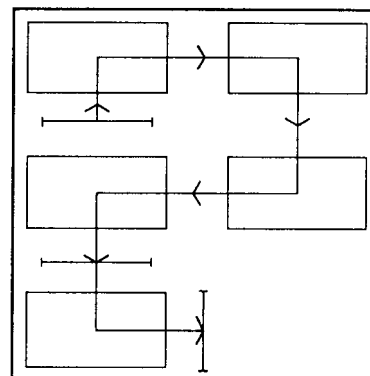

2.3: Nomograph

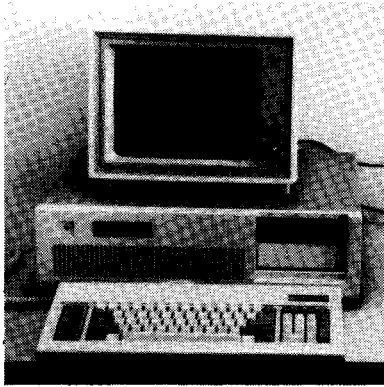

2.4: A Microcomputer

**Programs.** The proliferation of design tools based on microcomputer programs has been dramatic, corresponding to the growth of microcomputer use for other purposes in architectural and engineering offices. Because of their popularity and variety, microcomputer-based design tools are given the greatest emphasis in this booklet.

In general, a designer will *enter* some or all of the following kinds of information into a microcomputer-based design tool:

- Building description - building size and volume; wall, floor and ceiling area; window type, size and orientation
- Design data - wall, floor and ceiling insulation levels, infiltration rate; equipment efficiencies; material type and thermophysical properties
- Weather data - temperature, solar radiation, wind speed and possibly other local climatic variables
- Economic data - cost of auxiliary fuel; fuel escalation rate; cost of conservation or solar features

The tool will then calculate the energy and economic performance for a particular design and *provide* one or more of the following basic kinds of information:

- Auxiliary energy consumption and costs
- Annual, seasonal, monthly, daily, or hourly heating and cooling loads for the building, perhaps by building component
- Peak heating and cooling loads
- Hourly interior temperatures
- Economic performance of various alternative energy conservation and solar design options

Microcomputer design tools are especially relevant in the later stages of the design process, as greater design detail is available. These computer programs also enable the designer to determine the effect of varying one or more elements of the design, thus allowing the energy performance of the building to be optimized.

**Mainframe Computers.** Simulation programs for mainframe computers were the first design tools, the "ancestors" of the current generation. They are now used, for the most part, only by researchers. Because of the increased power now available in microcomputers, mainframe computers are rarely used in residential design, and thus are not discussed in this booklet.

The use of design tools can accelerate the design process by quickly identifying energy problems and opportunities and by narrowing the range of practical solutions, thus saving time and money for both designer and client.

Once a set of workable options is chosen, a design tool can "fine tune" the energy-saving and energy-supply strategies and indicate what the energy performance of the building is likely to be. The whole building will perform more effectively because the designer will have more information about the complex interaction between the solar features and the other elements of the building's design.

In addition to economy in the design process and better building energy performance, leading to higher occupant/client satisfaction, design tools are excellent "intuition builders." Repeated use gives the designer a greater sense of applicable design options for given climatic and programmatic conditions. The design process can move rapidly and smoothly when based on data from past experience.

Design tool accuracy is one of the user's most central concerns, and one of the most complex to assess. The user will want to use the tool with confidence and avoid liability for a design which does not perform properly.

Although design tools do vary in accuracy, it has been established that the majority of recently developed tools do what they say they can. However, the designer would be wise to make the effort to evaluate the technical accuracy and applicability of the energy design tools he or she is considering. International Energy Agency Task VIII researchers have developed a procedure that enables a designer or energy consultant to evaluate a design tool against a number of simple benchmark test cases that have been analyzed by several well-validated mainframe building energy analysis simulations(2). By comparing the design tool results against the simulation results, the accuracy and applicability of the design tool can be established.

It is important to remember that design tools are very useful for indicating whether a contemplated design change would improve or degrade energy performance, and by how much. They are less useful as crystal balls for predicting exactly how much energy a building will use, or what the energy bills will be. Although building energy calculation methods are becoming increasingly sensitive and sophisticated, there are variables that not even the most advanced design tools can quantify for certain, and they should be kept in mind while choosing a design tool and while evaluating its "accuracy":

- o The quality of construction - workmanship and materials - can vary considerably from one job to the next. This fact of life becomes particularly significant in designs that are dependent on air and vapor barriers, mass density,

## 2.3 WHY USE DESIGN TOOLS?

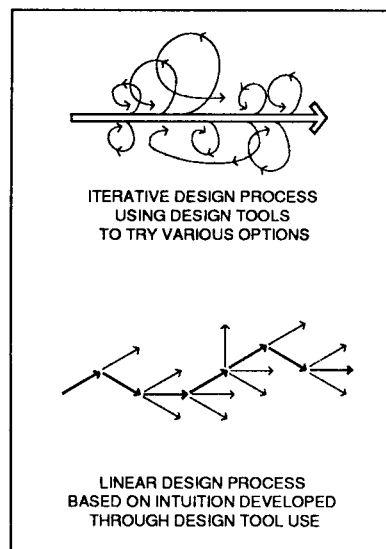

2.5: Enhanced Intuition

## 2.4 DESIGN TOOL ACCURACY

insulation, shell integrity and other factors which are often a part of passive solar houses. The variation in performance introduced by workmanship and materials quality cannot be quantified, but no one familiar with construction doubts that it is large.

- o Another major "unknown" is the efficiency of heating and cooling equipment. Installed efficiency ratings represent a means for comparison rather than an actual measurement or a value to be confidently expected. Actual efficiencies vary widely based on use, maintenance and system age, and have a large impact on how a building's heating and cooling loads translate into energy consumption and costs.
- o Finally, the factor most difficult to predict is the behavior of the building's occupants. Occupant behavior alone can cause very large differences in the performance of two otherwise identical buildings, and may not even be apparent until long after the design process is over. The classic examples of occupants compromising passive design are drapes covering direct gain windows and wall-to-wall carpet over the carefully-sized thermal mass. (See Booklet No.8, Post-Construction Activities, for information on occupant effects.)

The adjoining graph hypothetically estimates the energy performance variability caused by the above three factors. The numbers are approximations for purposes of illustration. Considering these "unknowns" and their relationship to building performance, two important lessons for design tool users can be drawn:

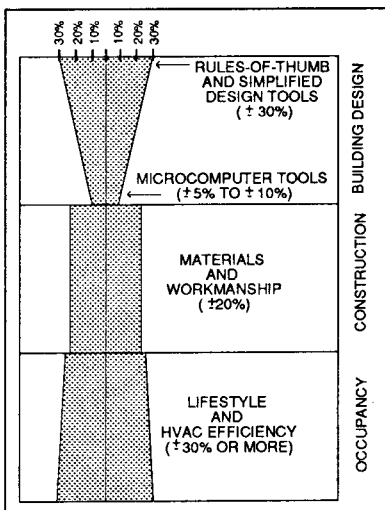

2.6: Hypothetical Variability of Predicted and Actual Performance

1. Current residential energy design tools, if properly used, will predict energy consumption of a particular building to a reasonably accurate degree. Thus they can also be used with confidence to assess the change in energy use associated with a change in building design.
2. While it is theoretically possible to accurately predict the future energy costs of a design, it would entail detailed information about the specific climate, occupancy behavior, workmanship, world events, and many other factors, and few designers have access to such information. Thus, a designer must be aware of the limitations posed by unknown factors when using a design tool to predict future energy costs. While this type of information may be requested by a client or used to arrange financing for the building, the prediction can only be an approximation of potential future energy costs and should be presented with the appropriate caveats and qualifiers.

The design process for a passive solar building is fundamentally the same as for a "conventional" building. Passive solar design does pose new issues, however, related to climate and to the building components that influence energy use. Energy design tools can help designers deal effectively with the complexity of these passive solar design issues, identify and resolve energy use problems, as well as analyze and fine tune the energy design.

However, design tools do not make design decisions or even suggest design modifications; they simply provide information that will help the designer make those decisions or indicate the impact of a decision or design modification.

Consequently, as the first step, the designer should have a good working knowledge of the basic concepts of passive solar design. Design tools are not a substitute for knowledge, but a means of quantifying, refining, and calculating the impact of the design decisions. Design Information Booklets No.1 (Energy Design Principles in Buildings), No.2 (Design Context), No.3 (Design Guidelines: An International Summary), and No.5 (Construction Issues) provide valuable information on passive solar design necessary to achieving a successful project.

Armed with information on the fundamentals of passive design, the designer can proceed to utilize one or more tools to assist in the energy-related decisions that must be made during the design process, to identify and resolve potential problems, and to assess the energy performance of the building.

The building design process is generally divided into the following phases (although terminology may differ from country to country):

- **Pre-Design** (Programming and site analysis)
- **Schematic Design** (Also referred to as the conceptual design phase)
- **Design Development** (Design refinement and material specification)
- **Construction Documents** (Design refinement and detailed drawings and specifications)
- **Construction Observation** (Ensuring design compliance)

At each phase of the design process, a different level of information is available to the designer, progressing from rough ideas in pre-design to very detailed information in construction documents.

Design tools are available for a variety of functions and levels of complexity. Some are intended to be used during specific design phases; for example, site analysis tools for pre-design, and microcomputer programs during design development for fine-

## 3.1 THE DESIGN PROCESS

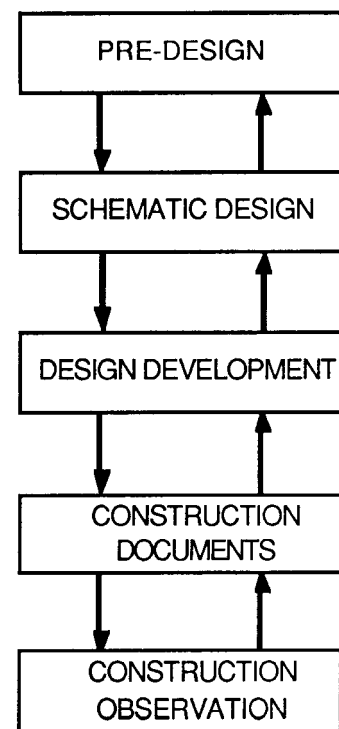

3.1: Design Process Diagram

tuning a design. Few tools are flexible enough to be equally useful throughout the design process. However, in actual practice the lines between design phases are not always clear-cut, and some design tools can be useful during more than one phase. For example, design guidelines can help during both the pre-design and schematic design phases, and microcomputer programs can help set goals during pre-design and also make precise calculations for energy code compliance in the later stages.

A discussion of the energy-related activities and decisions that take place in each phase and the appropriate tools is found in the following sections.

3.2 THE PRE-DESIGN PHASE

The best opportunities for improving a building's energy performance exist early in the design process, when basic decisions are made about the building's site, orientation, configuration, and the passive solar strategies to be employed. As it happens, however, the majority of design tools are applicable only in later stages because they require the input of details which are usually unavailable in the early design stages. Nevertheless, quite a few tools are available for the pre-design and schematic design phases which can serve as useful starting points for effective building concept generation.

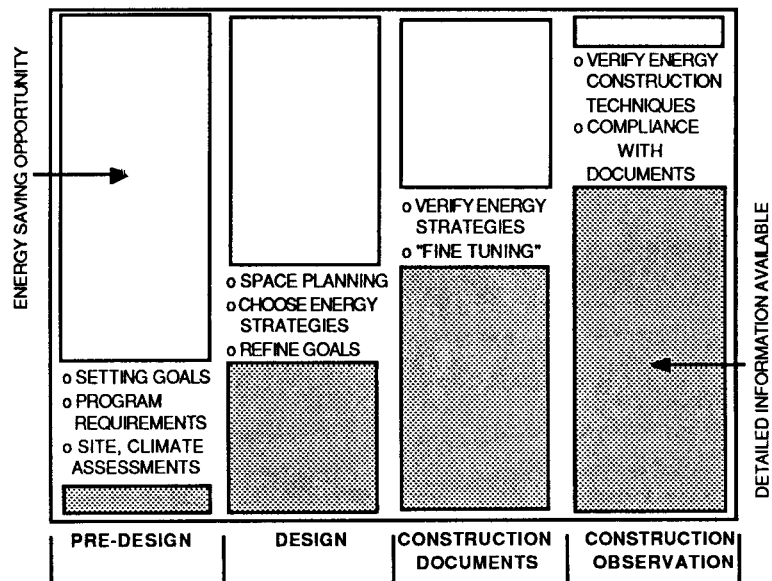

3.2: Energy Savings Opportunities and Design Process

ENERGY RELATED ISSUES IN THE PRE-DESIGN PHASE

The pre-design phase consists primarily of programming and site analysis. The major energy-related issues which must be addressed during this phase are:

1. Identification of the key energy use problem(s) and possible solutions;



2. Development of realistic energy performance goals;
3. Climate assessment; and
4. Shading analysis.

These initial activities are essential to the energy design process since the data gathered and decisions made at this early stage will have an important impact on the later design phases and establish the foundation for a successful passive solar building. The energy-related activities and the relevant tools for this design phase are discussed below.

Ultimately, the energy-efficiency of the building will be determined by how well the designer was able to identify the key energy use problem(s) and capitalize on opportunities for reduction of conventional energy use. To do this, the designer must understand the energy load, its components, and daily and seasonal variations.

A microcomputer design tool can be useful for breaking down total building energy use into its end-use loads, which in residential buildings is typically heating, cooling, and to a lesser extent lighting, domestic hot water, and other miscellaneous uses. Although for any given climate the relative importance of these broad categories is easy to assess, a design tool can break energy use in each major area down further. For instance, heating and cooling loads are comprised of:

- infiltration (heating and cooling)
  - ventilation (heating and cooling)
- conductive loads for various building components (heating and cooling)
- radiative loads for various building components (heating and cooling)
- solar loads (cooling)
- lighting, occupants and appliances (cooling)

To determine the energy load, its components and variations, the designer would develop a base case conventional house since details about the future design are not yet available. The microcomputer program is then used to analyze the energy loads and expected performance of that base case house.

With an understanding of the energy loads and energy use patterns for conventional homes in that climatic region, the designer can begin the critical task of identifying those passive solar and energy conservation strategies and devices he wishes to employ to reduce purchased energy consumption. The strategies selected will manipulate the load by minimizing conductive heat flow, minimizing infiltration, increasing solar gain and thermal storage, promoting ventilation cooling, minimizing solar gain, or minimizing external air flow to create a comfortable

interior environment during various seasons while reducing conventional energy consumption.

IDENTIFICATION OF ENERGY USE PROBLEMS AND SOLUTIONS

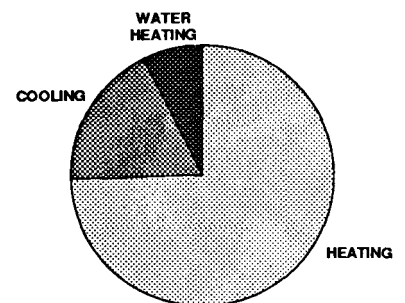

3.3: Energy Load by End Use

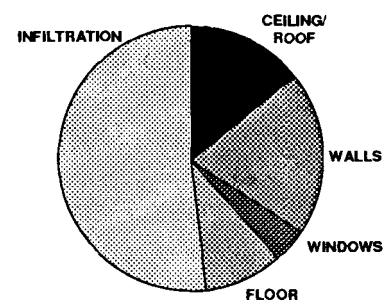

3.4: Heating Load by Component

### ESTABLISHING PERFORMANCE GOALS

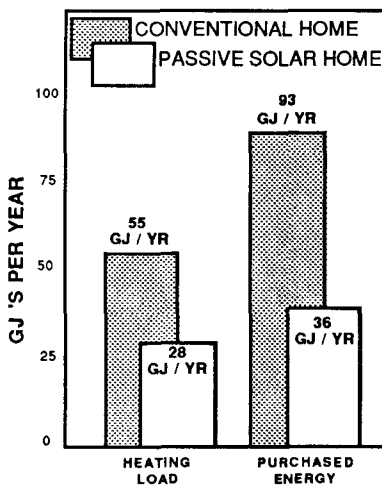

3.5: Energy Use Comparison

However, each load component interacts with other components and changing one may affect the others. Some design strategies affect two or more categories. Later in the design process, the same design tool used to model the base case house can be used to help study and track these complex relationships and their impact on energy performance for the design under development.

Ideally, passive solar and energy-efficient design should be based on specific and realistic energy performance goals established at the beginning of the design process and refined as necessary. Establishing the energy performance goals of a project is usually done at the same time as identification of energy use problems, using the same design tool. The energy performance of the base case building is used to derive reasonable performance expectations for the passive solar house in that location (Figure 3.5).

In addition to the reference point provided by the energy consumption of comparable non-passive solar houses, performance goals should be based on:

- An understanding of the microclimate in which the house will be located. The microclimate may be significantly different than the climate data used by the design tool
- Energy regulations and standards for residential buildings
- If a speculatively built house, the market requirements of the anticipated design
- Tradeoff between cost and energy savings
- Client preferences

Later in the design process, the microcomputer software can be used to evaluate what the space conditioning load will be as a result of the energy conservation and passive design features.

### CLIMATE ANALYSIS

Residential energy consumption is determined primarily by climate, making adequate information on solar radiation and other meteorological parameters essential to energy efficient design. While experience in a given climate is often sufficient for identifying the basic energy problem or problems, more specific data are required for effective passive solar design. In fact, climatic data are utilized in most phases of the design process.

For example, most microcomputer tools require solar radiation, ambient air temperature and other weather data for their building energy calculations. Design guidelines are also based on climatic data, although such information is generally embedded in the guidelines. And as indicated previously, climatic data are required in the pre-design phase to analyze conventional building

performance and to establish energy performance goals. For these reasons, climatic data collection should be an initial activity in the design process so that the information will be available as required during the design process.

Climate analysis requires acquisition of appropriate microclimatic or local solar radiation and weather data. Although collection of regional weather data is sometimes considered sufficient, in point of fact, a distance of even a few kilometers can make a significant difference in weather patterns and what design solutions would be effective. Therefore, local or site-specific weather data are preferred and will be more useful to energy efficient design.

Design tools typically require hourly, daily, or monthly average climatic data. Generally, design tools that use shorter time periods of weather data - hourly vs. monthly, for example - provide greater detail on component dynamics and temperature. The following weather data is typically required, particularly by a microcomputer simulation:

#### DESIGN TOOL CLIMATIC DATA REQUIREMENTS

- Hourly total solar radiation incident on a horizontal surface, divided into direct and diffuse, month by month
- Average hourly dry bulb temperatures, month by month
- Average hourly wet bulb temperatures or average hourly relative humidity, month by month
- Average hourly wind speed and direction, month by month
- Average number of days per month with frost, fog, snow and overcast skies

A microcomputer program can analyze and structure the climate data to provide answers to the following questions:

- During what periods of the year are heating and cooling required?
- During what periods of a 24-hour cycle are heating and cooling required (a full answer to this question might include analyses both of temperature swings and of occupancy patterns)?
- Are there periods when little or no conditioning is required? If so, can these periods be extended through careful building design?
- Is adequate solar radiation available for efficient passive solar design?
- Will added thermal mass be useful in reducing heating and cooling loads?

Booklet 2 (Design Context) contains a complete discussion on the kinds and sources of climatic data that will be useful in the design process as well as the format in which data are provided. This latter information is important since various design tools often have different requirements regarding the format in which the weather data must be entered.

SHADING ANALYSIS An initial task facing a designer of a passive solar home is analysis of the site from the perspective of building orientation, geometry and solar access. The objective is to achieve a building configuration and placement which maximize solar contribution and minimize undesired shading from nearby vegetation or buildings. For this task, a number of shading analysis tools are available, primarily physical modeling devices and graphic methods (although some computer methods have also been developed for this purpose), which will indicate shadows cast by the surrounding environment and by the building itself.

An example of a simple but effective site analysis tool is the southern skyline plot. To prepare a skyline chart, the following are needed: (1) a transit or compass, (2) a hand level, and (3) a copy of the sun chart for the site's location. A sun chart graphically indicates the position of the sun at each hour of each month of the year. In such charts, local time has been converted to solar time by applying correction factors to take into account rotation of the earth, difference in longitude between location and standard meridian of the time zone, and daylight savings time when in use. An example of a sun chart is shown in Figure 3.7.

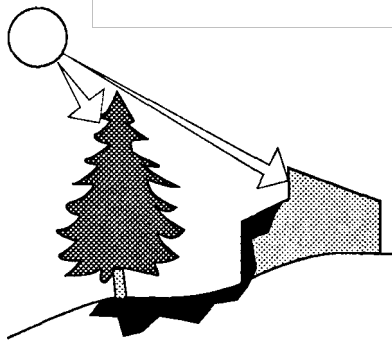

3.6: Site Shading

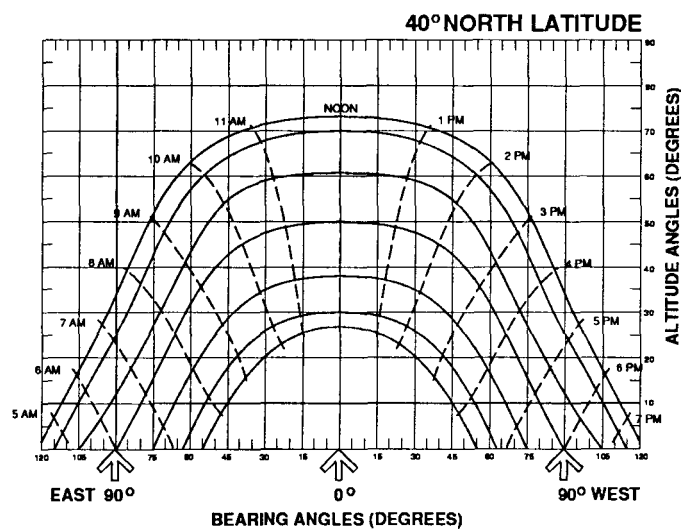

3.7: Sun Chart

The input for the skyline plot includes 17 measurements of skyline altitude, and azimuth and altitude angles for objects and trees on the skyline. The output is a sun chart on which the skyline has been plotted with the open areas indicating times when the sun will reach that point on the site. An illustration of a completed skyline plot is shown in Figure 3.8.

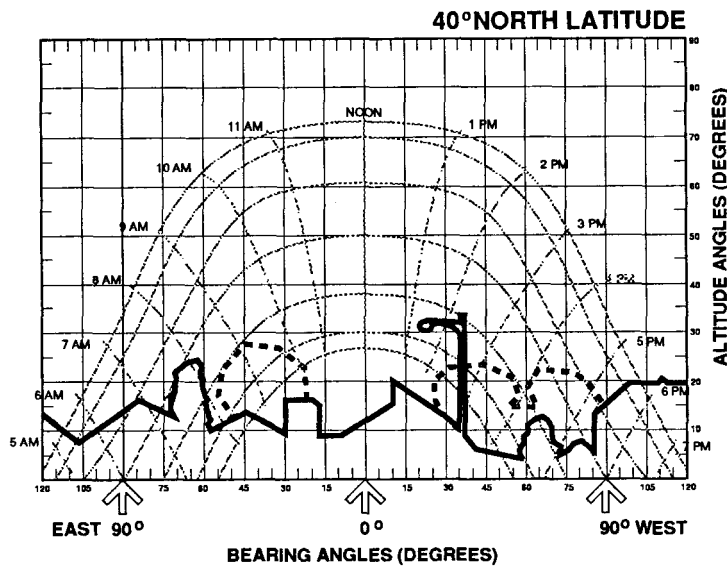

3.8: Skyline Plot

Tools such as these illustrate an important point about the pre-design phase. The tools are fairly simple, and the output is fairly simple as well, yet solar access is probably the most fundamental element in a passive solar design, and if the solar access is compromised, very little can be done to correct the mistake at advanced stages in the design.

By the beginning of the schematic design phase, the following information should be available:

- Climatic data
- Solar access analysis
- Approximate building size
- Space organization and relationship diagrams
- Occupant lifestyle and building use patterns
- Preliminary estimate of annual space conditioning needs
- A preliminary range of energy performance goals
- Candidate energy saving techniques

During the schematic design phase, the actual design of the building begins and evolves rapidly. A good energy design tool for this phase must provide a sound starting point for the design and allow the designer to quickly choose and evaluate proposed passive solar strategies.

The most useful type of tool in this phase are design guidelines. They contain recommended levels, ratios or sizes for the various elements of the passive solar design and often for other energy saving strategies as well. Figure 3.9 illustrates the energy design features typically covered in a set of design guidelines.

### 3.3 THE SCHEMATIC DESIGN PHASE

SITE PLANNING			ENVELOPE DESIGN			INTERIOR DESIGN			MECHANICAL EQUIPMENT		
	HTG	CLG		HTG	CLG		HTG	CLG		HTG	CLG
1. SOLAR ACCESS	●	●	1. BUILDING SHAPE	○	○	1. INTERIOR ZONING	●	●	1. MECHANICAL EQUIPMENT EFFICIENCY	●	●
2. ORIENTATION	○	○	2. INSULATION AND CONSTRUCTION MATERIALS	●	●	2. THERMAL MASS	●	●	2. MECHANICAL EQUIPMENT CONTROLS	●	●
3. LANDSCAPING	○	○	3. INFILTRATION REDUCTION	●	●	3. SOLAR APERTURE DESIGN			3. VENTILATION	○	○
			4. EXTERIOR SURFACE COLOR	○	○	a) direct gain windows	●	○	4. DOMESTIC HOT WATER	●	●
			5. GLAZING SELECTION AND LOCATION	●	●	b) thermal storage walls	●	●	5. FANS TO PROMOTE AIR MOVEMENT	○	●
			6. EXTERIOR SHADING	○	●	c) sunspace	●	○			
						4. DAYLIGHTING	○	○			
						5. MOVEABLE INSULATION	○	○			

● MAJOR      ● MODERATE      ○ MINOR      ○ NOT RECOMMENDED

3.9: Representative Energy Design Guideline Features

Design guidelines generally require little input by the user, making them easy to use. They are typically developed for a particular region of a country or a specific city and are generated using the appropriate microclimatic weather data. As such, the user must be careful to use guidelines suitable to the building location.

Design guidelines are extremely useful in providing a "starting-point" for energy design. They typically describe a range of energy-saving design options, recommended levels, sizes or types for each option, and often how energy performance will change if the recommendations are not followed. Sometimes the financial consequences of modifying a design strategy are provided.

Although guidelines with many different levels of complexity are available, most assist in roughly sizing the components of the passive solar design (for example, glazing type, area and location; thermal mass levels and configuration; insulation levels, and so on) and help define a basic energy-efficient home. The basic design can then be elaborated and refined with the confidence that an effective foundation for the design has been generated and significant energy problems have been avoided. Excerpts from several design guidelines are found in Figures 3.10 - 3.13.

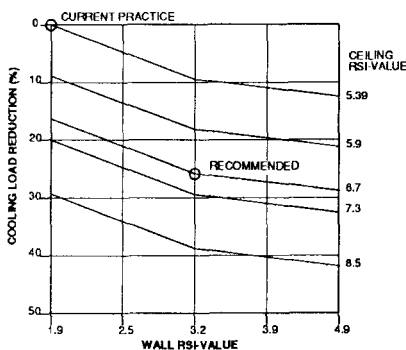

3.10

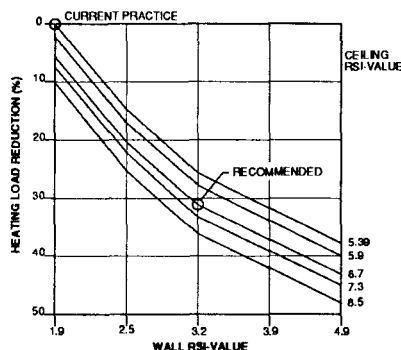

3.11

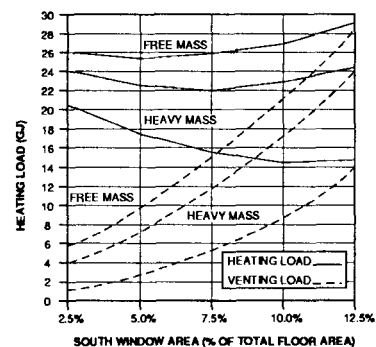

3.12

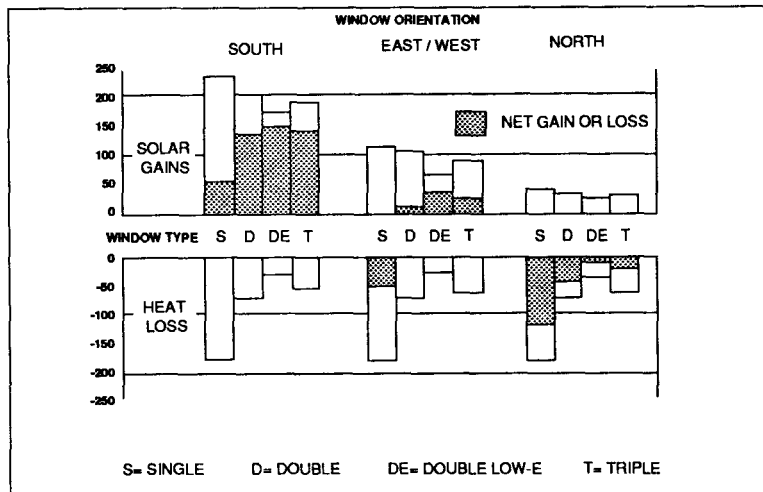

3.13: Window Energy Balance

As the building design progresses into the design development stage, the following information is available:

- Building location on site
- Building orientation and configuration
- Preliminary floor plans, elevations and sections
- Initial energy design strategies selected and represented on the drawings
- Basic building skin materials and insulation values
- Rough estimate of opaque and glazed surfaces and orientations
- Initial identification of heating and cooling systems

At this stage, the passive solar and energy saving strategies incorporated during the schematic design phase will be refined as more and more details of the design are developed and frozen.

The primary tools for the design development phase are microcomputer programs capable of performing detailed energy analysis. At this point, the level of detail required as input by most microcomputer tools is available, making it possible to utilize their analysis capability to calculate the energy performance of the passive solar house.

The analysis is based on a building description, including the energy design strategies selected and local climate data. The energy performance is usually expressed in terms of auxiliary energy required or heating and cooling loads and often interior temperatures and peak load information.

### 3.4 DESIGN DEVELOPMENT PHASE

```

7. WINDOWS (INCLUDING DOOR GLAZING)
Area   Glazing   Swann   Winter   Wall Entry
(sq ft) Orientation (1-6)   Factor   Shading Factor   Line # (25-31)
-----
32a --- 32b --- 32c --- 32d --- 32e --- 32f ---
33a --- 33b --- 33c --- 33d --- 33e --- 33f ---
34a --- 34b --- 34c --- 34d --- 34e --- 34f ---
35a --- 35b --- 35c --- 35d --- 35e --- 35f ---
36a --- 36b --- 36c --- 36d --- 36e --- 36f ---
37a --- 37b --- 37c --- 37d --- 37e --- 37f ---
38a --- 38b --- 38c --- 38d --- 38e --- 38f ---
39a --- 39b --- 39c --- 39d --- 39e --- 39f ---

ORIENTATION      GLAZING TYPE
1. South          1. Single
2. SE/SW          2. Double/Total
3. E/W            3. Double
4. NE/NW          4. Double/Low-E
5. North          5. Triple
6. Horiz.         6. Cor-filled
    
```

F1 DONE    F2 HOME    F3 QUIT

```

14. INFILTRATION

Value of   Type of   Infiltration
Cond Space Infiltration   Value
(cubic ft) Measurement   (ACH or sq in)
-----
62a ----- 62b ----- 62c -----

TYPE OF INFILTRATION MEASUREMENT
1. Estimated value
2. Measured infiltration value from tracer gas test
3. Equivalent leakage area from blower door test
    
```

F1 DONE    F2 HOME    F3 QUIT

3.14: Sample Microcomputer Input

PERFORMANCE SUMMARY				
Date: 10-15-1988				
ARCHITECTURAL ENERGY CORP 2540 FRONTIER RUE SUITE 201 BOULDER COLORADO (303) 444-4199				
ENERGYWISE HOMES 123 MAIN STREET BOULDER COLORADO (303) 123-4567		Model #22 1988 BUENA VISTA MODEL BOULDER COLORADO		
Location: DENVER, CO Conditioned Area (sf): 1726, 1728		Heating Degree Days: 6016 Cooling Degree Days: 625		
ANNUAL LOAD (Btu)	EXAMPLE	EKRONLEZ	DIFF	DIFF
Space Heating	30.8	24.1	6.7	21.8
Space Cooling	4.4	4.5	1.9	29.72
Water Heating	0.0	0.0		
ANNUAL CONSUMPTION (Btu)				
Space Heating	44.0	34.4	9.6	21.8
Space Cooling	2.6	1.8	0.8	29.7
Water Heating	0.0	0.0		
ANNUAL ENERGY COST (\$)				
Space Heating	\$220.00	\$172.14	\$47.86	21.8
Space Cooling	\$1.40	\$6.14	\$5.26	29.7
Water Heating	0.00	0.00		
Total	\$221.40	\$208.28	\$63.12	23.3
PEAK LOADS (kBtu/hr)				
Space Heating	23.1	20.2	2.9	12.6
Space Cooling	15.4	12.6	2.8	18.2
SPACE CONDITIONING ANNUAL PERFORMANCE FACTORS				
AREA NORMALIZED CONSUMPTION (kBtu/sf)				
Space Heating	25.5	19.9	5.5	21.8
Space Cooling	1.5	1.0	0.4	29.7
Total	27.0	21.0	6.0	22.2
CLIMATE NORMALIZED CONSUMPTION (Btu/sf/Degree Day)				
Space Heating	4.2	3.3	0.9	21.8
Space Cooling	2.4	1.7	0.7	29.7
NORMALIZED COST (\$/sf)				
Space Heating	\$0.51	\$0.40	\$0.11	21.8
Space Cooling	\$0.01	\$0.01	\$0.00	29.7
Total	\$0.52	\$0.40	\$0.11	21.9

3.15: Sample Output

Microcomputer tools are valuable because they:

- allow quick, accurate comparison of many energy design strategies;
- are capable of assessing the combined performance effect of varying one or more elements of the design; and
- can be used to "fine-tune" or optimize an energy design strategy.

In addition, some microcomputer tools, and even some nomographs, can examine economic as well as energy considerations. Since many strategies must be examined in the context of local economic conditions (for example, cost of fuel, cost of money, interest and fuel escalation rates), an economic analysis capability is often advantageous.

Microcomputer programs are also suited for the final energy calculation often required for compliance to a local energy code, energy rating system or loan approval.

Since the design development stage is a highly iterative process, a tool which allows quick design modifications without a lengthy input process is desirable since the designer typically will want to investigate a number of possible solutions.

It is also important to remember that although "detail of output depends on detail of input" is a good general rule of thumb, the *amount* of input detail does not necessarily dictate the *quality* of output. Too much detail in input can even increase user error, and so become counterproductive.

### 3.5 CONSTRUCTION

Major energy design issues should

preparation of construction documents; thus, the work of energy design tools are normally completed by this stage.

Nevertheless, it should be mentioned that the preparation of construction documents and the supervision of the actual construction are critical to achievement of energy performance goals. Special attention must be paid to clarity when specifying innovative components or details which might be unfamiliar to contractors or construction workers. Design intentions, particularly those related to passive solar energy-efficient building features, are easily compromised during construction. As discussed previously, variations in construction quality and material selection can have a large impact on how well the design translates into actual building performance. Observation of building construction should be done by the designer, if only to gain an appreciation of the potential for errors and variation during construction (see Booklet 5, Construction Issues).

be resolved before beginning  
DOCUMENTS  
AND CONSTRUCTION  
OBSERVATION



The following discussion on design tool selection applies primarily to evaluating the features of microcomputer design tools, since they are usually the most costly to acquire and the most complicated to evaluate.

The most important information a designer can bring to the design tool purchase decision is a clear understanding of how he or she intends to use the tool: for example, what kind of building and energy features will most often be analyzed, is economic analysis capability desired, what level of output detail is required, how "computer-literate" are the people who will routinely use the tool?

The answers to those questions will eliminate some tools from consideration, thus narrowing the field of candidates. The purchaser should then look closely at the basic characteristics and features of tools which appear to meet his or her user requirements.

Generally speaking, a microcomputer tool for evaluating passive solar residential building designs should be able to answer the basic question:

Does a design modification reduce or increase seasonal energy loads/consumption?

Although not all design tools can do so, another important basic question a tool should help answer is:

Does the modification reduce or improve thermal comfort?

Many energy design tools have the ability to calculate these factors, or claim to. Therefore, an initial screening process is important to reduce the number of tools being considered. In that screening process, the "shopper" should determine whether the design tool is able to:

- Evaluate detached single family and/or multi-family TOOL CAPABILITIES residential applications
- Calculate monthly, annual and/or seasonal energy consumption, divided into major use categories
- Calculate peak heating and cooling loads
- Evaluate or model desired passive solar and energy conservation strategies (direct gain windows, sunspace, thermal storage wall, and so on)
- Consider window shading (e.g., overhangs, interior or exterior blinds or curtains, trees, adjacent buildings and so on)
- Handle more than one passive solar strategy simultaneously

## 4.1 BASIC SELECTION CRITERIA

## 4.2 ASSESSING A DESIGN TOOL'S KEY CHARACTERISTICS

### VERIFICATION OF ACCURACY

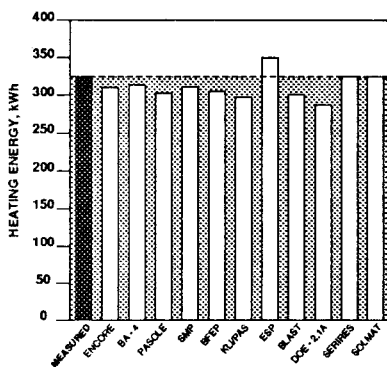

4.1: Accuracy Comparison

- Evaluate different types and thicknesses of thermal mass
- Indicate typical daily energy use and temperature profiles (not a common feature, but a very useful one)
- Indicate the economic implications of a design change
- Predict energy costs for the designed building

Few tools provide all these capabilities, so a designer must develop reasonable priorities based on experience, location and anticipated use.

Beyond the basic capabilities outlined above, there are a number of features that will strongly influence a design tool's usefulness to the designer and are important for the user to assess prior to selecting a tool. These features are considered individually below.

Design tool developers use a number of methods for verifying the accuracy of their tool. The most common procedure is to test the results of a new design tool against another respected and more detailed tool or analytical model. Developers are generally familiar with a variety of tools and can easily make comparative runs to develop percentages of variance. These are often presented to the user by stating that the tool is accurate to "within plus or minus 10 percent" of another tool. Reliability testing information is also often represented graphically for each load component, and is probably more useful in this form.

Validation of design tools against high-quality empirical data sets, with all variables carefully controlled over a significant time period, is highly desirable. It is seldom done except for detailed research tools because it is an expensive and time-consuming process, normally beyond the resources of most tool developers.

However, in lieu of comparison to measured data, design tool results can be compared to the results of detailed building energy analysis models. An International Energy Agency Report entitled "Design Tool Evaluation: Benchmark Test Cases" contains a number of benchmark test cases that have been analyzed by several validated simulation programs (3). The input data needed to evaluate these cases with a simplified design tool is provided along with the results for several climates. The design tool purchaser should request the tool developer to make these comparison runs or make the runs himself.

Regardless of the method, it is extremely important that the technical accuracy and limitation of the design tool be determined. Without this technical check, it is not possible to know if reasonable values are being calculated by the tool.

When evaluating design tool output against building performance data or output from other design tools, caution must be used with comparative values that sum various energy use or load components. For example, total energy use is made up of both heating and cooling energy. It would be possible for two tools to correspond closely in annual values while calculating significantly different values for both heating and cooling.

Such effects are called "compensating errors," and they can only be discovered if both sets of output or performance data are broken down into similar component parts. Because these errors can mask inaccuracy, it is wise to verify tool performance against another respected tool -- as opposed merely to comparing outputs -- so that specific load or energy use components can be compared.

The usefulness of a design tool is often a reflection of the complexity and clarity of the input and output data. The most powerful design tool may never be used if entering of building data is too cumbersome and if output data are too voluminous and complicated to interpret, or are poorly presented. On the other hand, the output may be in charts and graphs that are impressive to clients but not very helpful to designers. Thus, the form and level of input and output must be carefully assessed by the user to determine whether they are appropriate to his needs and experience.

Many design tools offer a selection of output formats and detail, allowing the user to match output complexity to a specific job or design phase. In addition, several tools now produce output files that are compatible with popular spreadsheet programs, expanding options for graphics and output manipulation.

An important feature of some computer-based design tools is an "error-trapping" or "error-checking" capability which will reject or note illogical input values. Basically a function of computer programming sophistication, error-trapping can save time by pointing out input errors as they occur. In addition, programs with this feature deliver an error message or wait for an appropriate input, rather than requiring the user to start the input process all over again if a mistake is made.

A design tool certainly should not be so complex that the user needs a lengthy manual to use it, but the manual should serve two important functions:

- o Direct a novice in the use of the tool; and
- o Present some detail on the technical aspects of the tool's development, reliability and calculation methodology.

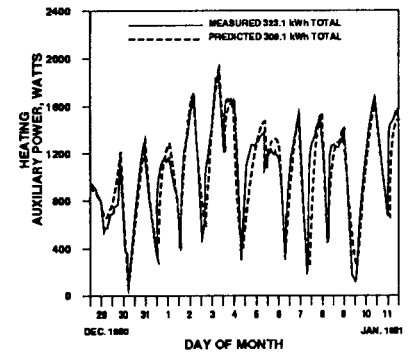

4.2: Load Data

EASE OF INPUT/ CLARITY OF OUTPUT

FLEXIBILITY OF OUTPUT

ERROR TRAPPING ABILITY

USER'S MANUAL

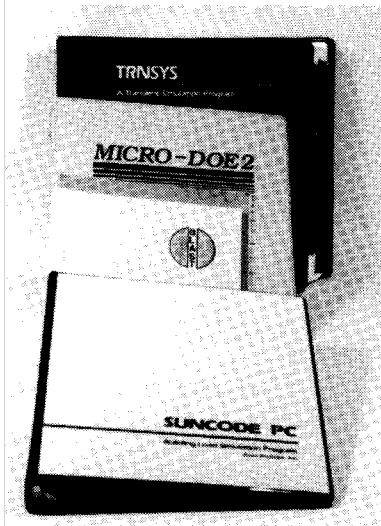

4.3: Example Manuals

AVAILABILITY OF TECHNICAL  
SUPPORT

DEFAULT VALUE FEATURE

SOURCE CODE INFORMATION

In the second capacity, the manual should serve as a reference book for the user, offering as much information as might be needed on the more subtle aspects of using the tool. The ideal manual would answer all the tool buyer's questions about the tool's strengths, weaknesses, ease of use and technical background. Unfortunately, buyers must usually settle for manuals that are somewhat short of ideal, but a buyer should look carefully at the manuals of the different tools he or she is considering, and ask the question: which manual clearly provides the information I will need to use the design tool?

Many computer design tools also feature separate engineering manuals, or have engineering sections in the user's manual. These engineering manuals provide detailed information about the algorithms, programming, and so on, and can be quite useful to someone interested in a greater level of detail.

Despite serious attempts to make design tools user-friendly and understandable, additional information from the tool developer is often helpful, particularly when trying to configure design tools for various computer systems or printers. Some tool developers offer a specific level of technical support to the user as part of owning the tool. In most cases, a potential tool buyer can get a good idea of the level of technical support necessary with a particular tool by talking to someone who already uses the tool, or by making a telephone call directly to the tool developer.

Some design tools have the capability of supplying "default" values if the actual values are not yet known or not yet developed. In the early design stages, this can be very helpful. However, the user should know exactly what values are assumed and the technical basis for these assumptions. This is especially true of "expert systems," and other sophisticated programs that attempt to eliminate detailed input requirements.

Whether the tool will automatically use a default value, if the user does not enter a required input value, is an important fact to know. The resulting tool may require less knowledge and save input time and cost, but the assumptions may also lead to inflexibility and potential errors. Even if the user decides to use the default values for easier input and saved time, he or she should at least be aware of the assumptions, so that extra caution can be exercised.

The original computer language text that directs the operation of the microcomputer design tool is called the "source code." The running version is usually compiled in a process which decreases the code run time while rendering the code impossible to read or retrieve. The technically knowledgeable tool user may be interested in obtaining an annotated source code for the design tool, as a means of finding out exactly how the tool is handling various components or variables, and to help the user update or customize a tool to meet specific needs. Often, however, the source code is not available, and at any rate, for the vast majority

of users the source code is no more interesting or relevant than the inside of a TV set. However, if it is likely that modifications to the source code will be made, and if the expertise exists to make these changes and recompile the code, then the ability to purchase the source code becomes an important design tool selection criterion.

User-Friendliness refers to the ease of use of a particular tool. The perception of user-friendliness will be influenced by a user's background, orientation and personal preferences. It is therefore difficult to provide specific guidance other than to say that when selecting a tool, the prospective user should attempt to assess (1) its suitability for the level of experience of the operator, (2) probable learning time, (3) speed of operation, (4) ease and number of inputs and other factors which will affect the convenience of the tool.

When shopping for a microcomputer-based design tool, the user should understand the equipment required by each tool he or she is considering. This includes (1) the micro-processor - a math co-processor may be required, (2) the display requirements - what graphics and color capability and resolution are needed for the monitor, and (3) the printer or plotter requirements to handle the numeric or graphic output.

In addition, the designer should ascertain that the program is written for the operating system of the machine he or she will use and that the amount of memory required to run the program is available.

In addition to reading literature provided by design tool developers and vendors on their products, a number of other options are available to the designer for gaining information before purchase.

The ideal situation would be for the designer to have an opportunity to work extensively with the tool before buying it, but such opportunities are rare. Sometimes, however, vendors offer demonstration disks that do everything but calculate. These are not expensive, and their cost is generally applicable to the tool purchase price. The use of these demonstration disks is an excellent way to get a feeling for the user-friendliness, input format and complexity of a tool. If demonstration disks are not available, the next best option is to attend a demonstration of the tool at energy conferences and trade shows.

In addition to product literature, the tool purchaser can find a number of non-proprietary articles on design tools in building and architectural trade magazines (5,6). Articles about individual solar buildings are also a good source of design tool information; the designers of the building usually indicate what design tools they employed.

USER-FRIENDLINESS

HARDWARE REQUIREMENTS

### 4.3 COMPARISON SHOPPING

DEMONSTRATION DISKS

TRADE PUBLICATIONS

**EVALUATIONS AND SURVEYS** A number of design tool evaluations and surveys have been completed by IEA Task VIII (1, 2, 3) and other organizations, offering fairly complete listings of tools and results of tool testing. While these are useful for scanning the large number of tools for likely candidates, and for comparing tools, the buyer should remember that the field changes rapidly. Tools that are worth owning and using are updated periodically and occasionally even changed radically to add improved algorithms and capabilities, or to take advantage of advances in microcomputers.

**EXPERIENCED TOOL USERS** Finally, some of the most up-to-date information on design tools can be obtained from those who regularly use them in solar design. Many such individuals and firms have played a significant role in the advance of passive solar design and are quite knowledgeable about design tools and their evolution.

Often, these practitioners can be located through trade journals, local architectural societies, the architecture department in local universities, or the national solar energy association. Also, innovative building projects are often covered in the popular press.

#### 4.4 CHOOSING A DESIGN TOOL: A BASIC CHECKLIST

The following questionnaire and checklist is intended to serve as a practical guide to be used during the design tool selection process. It should be used in conjunction with the previous material in this booklet so that the terms and characteristics mentioned in the checklist will be clearly understood. The general emphasis is on selection of microcomputer-based tools. These same checklists are presented in Appendix B in a full page format so that they can be copied and used during the design tool selection process.

**Design Tool User Needs:**DESIGN TOOL USER'S NEEDS  
QUESTIONNAIRE

1. During which stage of the design process will the tool most often be used?
  - Pre-design
  - Schematic design
  - Design development
  - Entire process
  
2. What kind of buildings will typically be analyzed?
  - Single-Family Residences
  - Multi-family Residences
  
3. What types of energy conservation and passive solar features would you want the tool to handle?
  
4. Who will routinely use the design tool? How familiar or comfortable are they with computers and computer software?
  - Novice
  - Some experience
  - Very experienced
  
5. What kind of output is desired?
  - numerical
  - graphs
  - spread sheet
  - building loads
  - component loads
  - building consumption
  - component consumption
  - energy costs
  - peak loads
  - temperatures
  - all of the above
  
6. What kind of computer hardware does your office presently have?
  
7. Is economic analysis capability desired?
  - Yes
  - No

DESIGN TOOL EVALUATION  
CHECKLIST**Determining Design Tool Capabilities:**

1. What type of buildings is the tool capable of analyzing?
  - Single Family Residences
  - Multi-Family Residences
  
2. What passive solar and energy conservation features can it model?
  
3. Can it handle multiple zones?
  
4. Can it perform parametric sensitivity studies during a single run or can it be set up to make multiple runs?
  
5. Can the design tool handle more than one kind of solar energy strategy simultaneously?
  
6. What kind of hardware requirements does the tool have?
  - Microprocessor\_\_\_\_\_
  - Monitor\_\_\_\_\_
  - Printer\_\_\_\_\_
  - Plotter\_\_\_\_\_
  - Operating System\_\_\_\_\_
  - Memory Requirements\_\_\_\_\_
  
7. How would you characterize the input requirements?
  - Minimal (probably not sufficient)
  - Reasonable
  - Extensive but acceptable
  - Excessive and burdensome
  
8. Is the program, or parts of the program, interactive?



19. Is the user's manual clear and helpful?
20. Is technical support after purchase readily available from the vendor?
21. What is the experience of other professionals who have used this design tool in actual practice?
22. What is the cost of the tool?



4.4: Passive Solar Home, Oslo, Norway

The value of energy design tools for achieving significant building energy savings has been well-established over recent years. The "right" design tool can save a designer time and money, improve client satisfaction, suggest energy opportunities that might otherwise be overlooked, and solve energy problems while they are still on the drawing board instead of built into a house that will be occupied for fifty or more years.

Although it is true that choosing a design tool involves careful preparation and that a design tool's performance can be influenced by many and often subtle factors, the prospective tool user should not be intimidated. Design tools are more sophisticated than ever before, and many of the problems present when the technology was new have been worked out over a period of intense research and widespread use. Buildings designed with the help of design tools have been studied and, more importantly, occupied for some time, so that the accuracy of tools has been substantiated by actual performance.

The likelihood that a reasonably well-informed buyer might make a "mistake" and choose an irretrievably "wrong" design tool is relatively minor, compared to the many benefits to be gained from designing energy-efficient, high-quality buildings with the help of energy design tools.

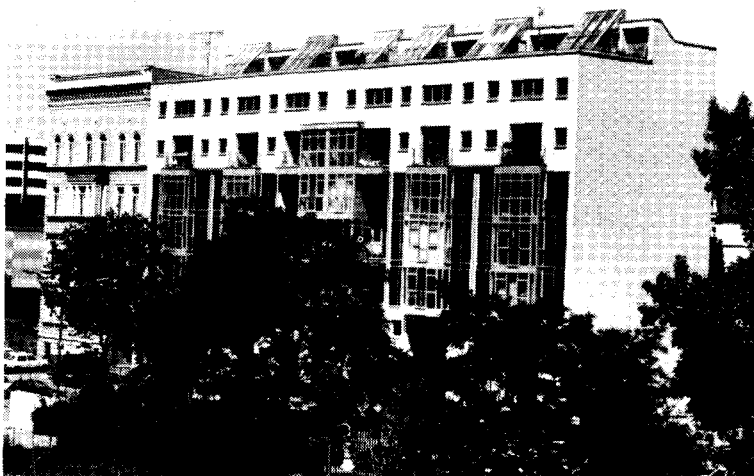

5.1: Passive Solar Apartments, Berlin, Germany

1. International Energy Agency Solar Heating and Cooling Programme, Design Tool Survey, Task VIII Passive and Hybrid Solar Low Energy Buildings, May 1985.
2. International Energy Agency Solar Heating and Cooling Programme, Design Tool Evaluation Report, Task VIII Working Document, February 1985.
3. International Energy Agency Solar Heating and Cooling Programme, Design Tool Evaluation Exercise: Benchmark Test Cases, UK Building Research Establishment, Document #T.8.B.5., December 1988.
4. Commission of the European Communities, European Passive Solar Handbook - Basic Principles and Concepts for Passive Solar Architecture, Directorate - General XII for Science, Research and Development, 1986.
5. Solar Age, "Snazzy Software," pp. 26-28, May 1984.
6. Solar Age, "The Best Energy Software," pp. 10-13, May 1986.
7. Edward Mazria, The Passive Solar Energy Book, Rodale Press, 1979.

# APPENDIX A: NATIONAL DESIGN TOOLS

---

## AUSTRIA

**Design Tool Name:** BBH

**Description:** This microcomputer design tool calculates the seasonal energy balance of a house according to the VDI-method. The program includes a procedure that automatically calculates an economic optimum for energy saving features.

**Contact:** Institute of Energiewirtschaft der Tu Wien  
Gusshausstrasse 25-27  
A-1040 Wien  
AUSTRIA

Telephone: (222) 5601 / 5200

**Design Tool Name:** EBIWAN II

**Description:** EBIWAN II is a microcomputer based method that calculates a monthly and seasonal energy balance of small buildings. The program also can analyze the economic performance of energy design features.

**Contact:** Bundesinnung Sanitaer/Heizung  
Wiedner Hauptstrasse 63, Postfach 352  
A-1045 Wien  
AUSTRIA

Telephone: (222) 6505 / 3275

**Design Tool Name:** GEBA

**Description:** This design tool calculates the heating and cooling performance of a building with up to 200 rooms (zones) using a Fourier method.

**Contact:** Dr. W. Heindl  
Buero of Angewandte Mathematik  
Lugeck 1-2  
A-1010 Wien  
AUSTRIA

Telephone: (222) 52 62 04

## APPENDIX A: NATIONAL DESIGN TOOLS

---

**Design Tool Name:** RAUM

**Description:** RAUM calculates the heating and cooling performance of a single room according to the Fourier method.

**Contact:** Dr. W. Heindl  
Buero of Angewandte Mathematik  
Lugeck 1-2  
A-1010 Wien  
AUSTRIA

Telephone: (222) 52 62 04

### BELGIUM

**Design Tool Name:** LPB4

**Description:** LPB4 is a static multi-zone (maximum of 12 zones) microcomputer program that calculates interior temperatures with or without heating, power required to maintain a setpoint temperature, and energy consumption for heating in residential and commercial buildings. Direct gain and sunspace passive heating strategies can be analyzed with LPB4.

**Contact:** Laboratoire de Thermodynamique  
University de Liege  
Faculte des Sciences Appliquees  
Rue Ernest Solvay, 21 - Bat. C3  
B-4000 Liege  
BELGIUM

Telephone: (41) 52 01 80 Ext. 311  
Telex: 41397 UNIVLG B

### CANADA

**Design Tool Name:** HOTCAN - HOT2000

**Description:** HOTCAN is a microcomputer program that calculates on a monthly basis the annual space heating requirements of residential and small commercial buildings. The calculation procedure accounts for the effects of solar gain on all window ventilation, south window shading, infiltration, thermal mass and internal heat gains. The passive solar calculation is based upon the Barakat solar utilization method.

**Contact:** Division of Building Research  
Natural Research Council of Canada  
SASKATOON, Saskatchewan S7N 0W9  
CANADA

Telephone: (306) 665-4200

## APPENDIX A: NATIONAL DESIGN TOOLS

---

### DENMARK

**Design Tool Name:** SBI - 148: Calculation of Energy Consumption in Small Houses

**Description:** SBI - 148 calculates the monthly and annual net energy consumption for heating and ventilation using standard assumptions for internal heat gain, solar radiation and domestic hot water use. A theoretical maximum and minimum net heating energy consumption is calculated, and according to the building's actual mass a revised net heating consumption is determined.

**Contact:** Danish Building Research Institute  
P.O. Box 119  
D-2970 Hoersholm  
DENMARK

Telephone: (46) 286-5533  
Telex: 37529 DTHDIA DK

### GERMANY

**Design Tool Name:** DIN 4701 and VDI 2067

**Description:** DIN 4701 and VDI 2067 are manual degree day methods for calculating annual heating energy demand and heating energy cost, respectively. DIN 4701 is used to size the heating system while VDI 2067 calculates the occupancy load during the heating season. Neither method accounts for the performance of passive solar heating.

**Contact:** Beuth Verlag GmbH  
Burggrafenstrasse 6  
D-1000 Berlin 30  
FEDERAL REPUBLIC OF GERMANY

Telephone: (30) 2601-260

**Design Tool Name:** ISO DP 9164

**Description:** This programmable calculator or microcomputer design tool is a steady-state method that calculates monthly and annual heating energy load and consumption. Solar gains through windows is considered.

**Contact:** Dr. H. Werner  
IBP Fraunhofer Institute fur Bauphysik  
Postfach 1180  
D-8150 Holzkirchen  
FEDERAL REPUBLIC OF GERMANY

Telephone: (8024) 643-12

## APPENDIX A: NATIONAL DESIGN TOOLS

---

**Design Tool Name:** K-eff Method

**Description:** This manual design tool is a steady-state calculation procedure using heating degree days with K-values modified to account for solar gains.

**Contact:** Dr. Karl Gertis  
IBP Fraunhofer Institute fur Bauphysik  
Nobelstrasse 12  
D-7000 Stuttgart 80  
FEDERAL REPUBLIC OF GERMANY

Telephone: (711) 6868-302

### NETHERLANDS

**Design Tool Name:** M-5000

**Description:** M-5000 is a correlation-based manual and microcomputer heating energy calculation method applicable for residential buildings that incorporate direct gain, sunspace or thermal storage wall passive systems, open solar air-collectors and heat recovery.

**Contact:** Mr. Michel Raoust  
SCPA Claux-Pesso-Raoust  
70 Boulevard de Megenta  
F-75010 Paris  
FRANCE

Telephone: (1) 420 65 320

**Design Tool Name:** TPD-METODE

**Description:** TPD is a manual static heating loads calculation method that incorporates target values for different building components.

**Contact:** Stichting ISSO  
P.O. Box 20740  
N-3001 Rotterdam  
NETHERLANDS

## APPENDIX A: NATIONAL DESIGN TOOLS

---

**Design Tool Name:** Verbeterde Graaddagen Methode

**Description:** A simplified, manual heating energy calculation method based on heating degree hours.

**Contact:** TU Eindhoven  
Fago Hoofdgebouw 11-77  
P.O. Box 513  
N-3500 Eindhoven  
NETHERLANDS

Telephone: (40) 472 715

### NORWAY

**Design Tool Name:** FRES

**Description:** This is an interactive PC program for calculating the thermal climate and the heating/cooling load hour by hour. A temperature stratification model is included for sunspace/atria.

**Contact:** SINTEF  
Attn.: Terje Jacobson  
Division of Applied Thermodynamics  
N-7043 Trondheim  
NORWAY

Telephone: (7) 593871  
Telex: 55620 sintf n

**Design Tool Name:** NS 3031

**Description:** NS 3031 is a national standard for annual and monthly calculation of energy and power consumption in buildings. It accounts for solar gains through windows. The standard is available as an interactive microcomputer program with the necessary climate data included.

**Contact:** Norges Byggstandardisningsrad  
Kobenhavngt 10  
N-0566 Oslo 5  
NORWAY

Telephone: (2) 355020



## APPENDIX A: NATIONAL DESIGN TOOLS

---

### SWEDEN

**Design Tool Name:** BKL

**Description:** A manual method for calculating monthly and annual heat requirements for houses with direct gain passive systems.

**Contact:** Arkitektur-Husbyggrad, KTH  
S-100 44 Stockholm  
SWEDEN

Telephone: (8) 787 7000

**Design Tool Name:** MEPA

**Description:** A microcomputer program that calculates heating and cooling loads in direct gain passive solar residential buildings.

**Contact:** Royal Institute of Technology  
Architecture - Department of Building Design  
S-100 44 Stockholm  
SWEDEN

Telephone: (8) 787 7000

### SWITZERLAND

**Design Tool Name:** LESOSAI

**Description:** A simple to use analysis tool for passive solar houses. It computes solar contribution and auxiliary heating requirements on a monthly basis, using a personal computer. A user's manual is available in either French or German.

**Contact:** Group Research Energy Solaire  
Building LESO  
CH-1015 Lausanne  
SWITZERLAND

Telephone: (21) 693 45 45

## APPENDIX A: NATIONAL DESIGN TOOLS

---

### UNITED KINGDOM

**Design Tool Name:** BREADMIT

**Description:** This is an interactive microcomputer heating and cooling load and temperature prediction tool based on the BRE/CIBSE steady cyclic admittance theory. Calculations are performed for a typical day.

**Contact:** R. Alpey  
Building Research Establishment  
Department of the Environment  
Garston, Hertfordshire  
UNITED KINGDOM

Telephone: (923) 894040  
Telex: 923 220

**Design Tool Name:** BREDEM - 8

**Description:** BREDEM uses a time averaged energy balance approach, considering building design, heating system performance, occupant requirements and weather. Manual, hand-calculator and microcomputer versions of the method are available.

**Contact:** G. Henderson  
Building Research Establishment  
Department of the Environment  
Garston, Hertfordshire  
UNITED KINGDOM

Telephone: (923) 894040  
Telex: 923 220

**Design Tool Name:** SCRIBE MODELLER

**Description:** A micro computer aided system for modeling and evaluation of designs, and the production of detailed 2 and 3 dimensional drawings. SCRIBE MODELLER is primarily an architectural modeling system.

**Contact:** Ecotech Design Ltd.  
45, Harefield Road  
Sheffield, S11 8NU  
UNITED KINGDOM

Telephone: (742) 680982

## APPENDIX A: NATIONAL DESIGN TOOLS

---

**Design Tool Name:** SERILINK

**Description:** A utility for the conversion of building data contained in a computer model produced using the SCRIBE MODELLER system (or compatible data) into data which can be formatted for direct use by a thermal modeling system, in this case SERIRES (SUNCODE) building energy analysis simulation.

**Contact:** Ecotech Design Ltd.  
45, Harefield Road  
Sheffield, S11 8NU  
UNITED KINGDOM

Telephone: (742) 680982

### UNITED STATES

**Design Tool Name:** CALPAS 3

**Description:** CALPAS 3 is an hourly simulation microcomputer program that calculates heating and cooling loads, consumption and costs for residential and small commercial buildings.

**Contact:** Berkeley Solar Group  
3140 Martin Luther King Jr. Way  
Berkeley, California 94703  
USA

Telephone: (415) 843-7600

**Design Tool Name:** CIRA or EEDO

**Description:** CIRA is a microcomputer program that calculates the daily and nightly heating and cooling requirements of residential buildings. Monthly and annual energy consumption and costs are also determined. EEDO is the IBM microcomputer version of CIRA. The effect of sun on building surfaces is considered.

**Contact:** for CIRA:  
Lawrence Berkeley Laboratory  
University of California  
Berkeley, California 94720  
USA

Telephone: (415) 486-4029

for EEDO:  
Burt Hill Kosar Rittelmann Associates  
400 Morgan Center  
Butler, Pennsylvania 16001  
USA

Telephone: (412) 285-4761

## APPENDIX A: NATIONAL DESIGN TOOLS

---

- Design Tool Name:** F-LOAD
- Description:** An interactive microcomputer program that calculates monthly and annual heating and cooling loads for residential buildings.
- Contact:** Beckman-Duffie and Associates  
4406 Fox Bluff Road  
Middleton, Wisconsin 53567  
USA  
  
Telephone: (608) 263-1590
- Design Tool Name:** MICROPAS
- Description:** This design tool is an hourly simulation microcomputer program using a truncated weather year to calculate heating and cooling loads and consumption of residential and small commercial buildings.
- Contact:** Enercomp  
757 Russell Boulevard, Suite A 3  
Davis, California 95616  
USA  
  
Telephone: (916) 753-3400
- Design Tool Name:** REM/DESIGN
- Description:** REM/DESIGN is a manual and microcomputer program using generalized heat balance equations that calculate heating and cooling loads, consumption and costs for conventional and energy efficient passive solar residential buildings. The method accounts for solar gains on surfaces and through windows, internal gains, thermal mass and other energy design features.
- Contact:** Architectural Energy Corporation  
2540 Frontier Avenue, Suite 201  
Boulder, Colorado 80301  
USA  
  
Telephone: (303) 444-4149  
Fax: (303) 444-4304
- Design Tool Name:** SLR - ASHRAE Manual
- Description:** SLR is a manual correlation-based passive solar heating calculation method. The manual contains SLR sensitivity curves for approximately 100 passive solar heating system types.
- Contact:** ASHRAE Publications Sale  
1791 Tullie Circle, N.E.  
Atlanta, Georgia 30329  
USA  
  
Telephone: (404) 636 - 8400

## APPENDIX A: NATIONAL DESIGN TOOLS

---

**Design Tool Name:** SUNCODE/PC

**Description:** SUNCODE/PC is a menu-driven hourly simulation microcomputer program that calculates heating and cooling loads in residential and small commercial buildings.

**Contact:** Architectural Energy Corporation  
2540 Frontier Avenue, Suite 201  
Boulder, Colorado 80301  
USA

Telephone: (303) 444-4149  
Fax: (303) 444-4304

**Design Tool Name:** SUNDAY

**Description:** SUNDAY is a single-node hourly simulation microcomputer program using daily weather data that calculates heating and cooling loads for residential and small commercial buildings. Program accounts for internal and solar gains, heating and cooling setpoint temperatures and thermal mass.

**Contact:** Architectural Energy Corporation  
2540 Frontier Avenue, Suite 201  
Boulder, Colorado 80301  
USA

Telephone: (303) 444-4149  
Fax: (303) 444-4304

**Design Tool Name:** SUNPAS

**Description:** Interactive solar analysis program based on SLR method. Uses building configuration, location, thermostat setting, internal gain and other factors to calculate auxiliary heating energy for passive solar houses.

**Contact:** Solarsoft, Inc.  
1406 Burlingame Avenue, Suite 31  
Burlingame, California 94010  
USA

Telephone: (415) 342-3338

# APPENDIX B: DESIGN TOOL SELECTION CHECKLIST

---

## Design Tool User Needs:

1. During which stage of the design process will the tool most often be used?

- Pre-design
- Schematic design
- Design development
- Entire process

2. What kind of buildings will typically be analyzed?

- Single-Family Residences
- Multi-family Residences

3. What types of energy conservation and passive solar features would you want the tool to handle?

### Envelope

- Multiple Glazings
- Advanced Glazings
- Added Insulation
- Radiant Barrier
- Air Barrier
- Moisture Barrier
- Infiltration Reduction
- Ground Coupling

### Architectural Design

- Interior Thermal Zoning
- Interior Thermal Coupling
- Exterior Surface Color
- Window Shading

### HVAC Equipment

- High Efficiency HVAC Equipment
- Heat Recovery (heat pumps/exchangers...)
- Duct/Pipe Insulation
- Destratification

### HVAC Controls

- Time Clocks
- Energy Management System
- Demand Controllers
- Off-Peak Load Management

### Hybrid Solar Heating

- Air-Cooled Collector w/Hollow Mass
- Air-Cooled Collector w/Rockbed
- Liquid Cooled Collector w/Mass
- Sunspace with Rockbed

## APPENDIX B: DESIGN TOOL SELECTION CHECKLIST

---

### Passive Solar Heating

- Direct Gain
- Thermal Storage Wall
- Thermal Storage Roof
- Sunspace
- Thermosiphon Air Panel
- Moveable Insulation
- Reflectors (to enhance insolation)
- Phase Change Storage Materials
- Selective Surfaces

### Cooling

- Ventilation
- Roof Pond

4. Who will routinely use the design tool? How familiar or comfortable are they with computers and computer software?

- Novice
- Some experience
- Very experienced

5. What kind of output is desired?

- numerical
- graphs
- spread sheets
- building loads
- component loads
- building consumption
- component consumption
- energy costs
- peak loads
- temperatures
- all of the above

6. What kind of computer hardware does your office presently have?

7. Is economic analysis capability desired?

- Yes
- No

### Determining Design Tool Capabilities:

1. What types of buildings is the tool capable of analyzing?

2. What passive solar and energy conservation features can it model?

#### Envelope

- Multiple Glazings
- Advanced Glazings
- Added Insulation
- Radiant Barrier
- Air Barrier
- Moisture Barrier
- Infiltration Reduction
- Ground Coupling

#### Architectural Design

- Interior Thermal Zoning
- Interior Thermal Coupling
- Exterior Surface Color
- Window Shading

#### HVAC Equipment

- High Efficiency HVAC Equipment
- Heat Recovery (heat pumps/exchangers...)
- Duct/Pipe Insulation
- Destratification

#### HVAC Controls

- Time Clocks
- Energy Management System
- Demand Controllers
- Off-Peak Load Management

#### Passive Solar Heating

- Direct Gain
- Thermal Storage Wall
- Thermal Storage Roof
- Sunspace
- Thermosiphon Air Panel
- Moveable Insulation
- Reflectors (to enhance insolation)
- Phase Change Storage Materials
- Selective Surfaces



## APPENDIX B: DESIGN TOOL SELECTION CHECKLIST

---

### Hybrid Solar Heating

- Air-Cooled Collector w/Hollow Mass
- Air-Cooled Collector w/Rockbed
- Liquid Cooled Collector w/Mass
- Sunspace with Rockbed

### Cooling

- Ventilation
- Roof Pond

3. Can it handle multiple zones?

4. Can it perform parametric sensitivity studies during a single run or can it be set up to make multiple runs?

5. Can the design tool handle more than one kind of energy saving strategy simultaneously?

6. What kind of hardware requirements does the tool have?

Microprocessor \_\_\_\_\_  
Monitor \_\_\_\_\_  
Printer \_\_\_\_\_  
Plotter \_\_\_\_\_  
Operating System \_\_\_\_\_  
Memory Requirements \_\_\_\_\_

7. How would you characterize the input requirements?

- Minimal (probably not sufficient)
- Reasonable
- Extensive but acceptable
- Excessive and burdensome

## APPENDIX B: DESIGN TOOL SELECTION CHECKLIST

---

8. Is the program, or parts of the program, interactive?
  
9. What is the probable learning time for the program? How would you assess its ease of use?
  
10. Is the program iterative to allow quick design modifications without lengthy input?
  
11. What output can the tool provide?
  - Energy loads by end-use and by component
  - Auxiliary energy consumption by end-use and by component
  - Interior temperatures
  - Solar contribution
  - Climatic data
  - Listing of input values
  - Economic assumption
  - Energy costs
  
12. Is the output format clear and easy to interpret?
  
13. What is the run time for a typical problem?
  
14. Does the tool have an "error-trapping" ability (this is easily determined by entering illogical values and checking the tool's "reaction")?

## APPENDIX B: DESIGN TOOL SELECTION CHECKLIST

---

15. Does the tool vendor present the verification information (tool-to-tool comparisons, for example) clearly?
  
16. Does the tool vendor offer information about the tool's development?
  
17. Does the tool have a default value capability? Are the assumptions for the default values clearly explained?
  
18. Is source code information available, if desired?
  
19. Is the user's manual clear and helpful?
  
20. Is technical support after purchase readily available from the vendor?
  
21. What is the experience of other professionals who have used this design tool in actual practice?
  
22. What is the cost of the tool?